



**XA PUMP**





ISO9001:2000

# XA SERIES



## Model Form

For example,

**XA 65 / 20 G - CI - BR - SS - MS - OL - ANSI**

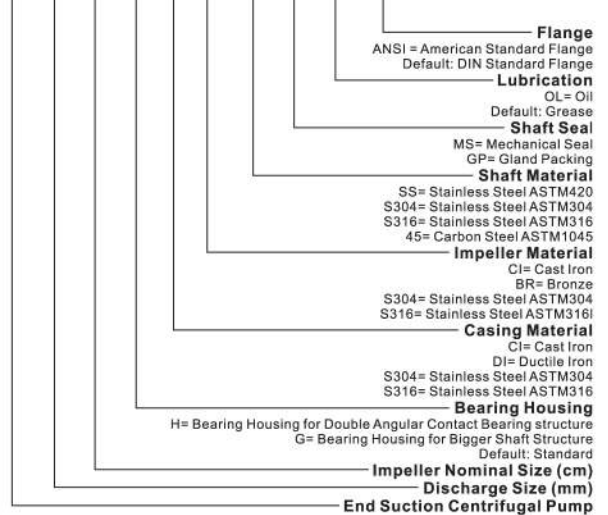

## Description

**XA** pump complies fully to the European Standard BS EN733 / DIN 24255 of performance and dimensions. They are used for pumping clean water or liquids similar to water, achieving wide application in plants, mines, city water supplies, air-conditioning coolers, fire-fighting system and irrigation.

Pumps of the same model have different performance levels basing on different diameter after impeller trimming. Overall the whole series, there are only four sizes of shaft and five of bearing housing. As long as their bearing housings are of the same size, different pumps can interchange spare parts such as shaft, shaft sleeve, shaft seal, impeller nut, etc.

**XA** pump is also very easy to be installed and maintained. Back pull-out design, driven through flexible coupling, so that pump casing and motor can be remains in position while other spare parts are removed.

**Design:** Performance and dimensions referring to the European standard BS EN733/ DIN24255.

**Structure:** Horizontal, Axial End-Suction, Single-Stage, Single-Suction, Volute Casing, Back pull-out, Centrifugal Pump

**Flange:** DIN2501 (ISO7005.2 or GB/T17241.6 PN1.6) standard, ANSI B16.5 Class150lb optional

**Rotation:** Clockwise viewing from the drive side

### Material:

Casing –Cast Iron standard, Ductile Iron, Stainless Steel optional  
 Impeller –Bronze standard, Cast Iron, Stainless Steel optional  
 Shaft –ASTM420 standard, ASTM304, ASTM316, ASTM1045 optional  
 Shaft Seal –Mechanical Seal standard  
 (Carbon-Ceramic/Viton standard, Caron-Sic/Viton optional),  
 Gland Packing optional

### Operating Range:

Flow Rate (Q): 2-1100m<sup>3</sup>/h  
 Head (H): 2-150m  
 Speed: 1450 or 2900 rpm (50Hz)  
 1750 or 3500 rpm (60Hz)  
 Temperature: -10°C to 105°C  
 Working Pressure: 10 Bar standard, 16 Bar on request

## Structure Drawing

- | No. | Spare Part      |
|-----|-----------------|
| 1   | Volute Casing   |
| 2   | Impeller Nut    |
| 3   | Wear Ring       |
| 4   | Impeller        |
| 5   | Casing Cover    |
| 6   | Shaft Spacer    |
| 7   | Mechanical Seal |
| 8   | Seal Cover      |
| 9   | Slinger         |
| 10  | Bearing Housing |
| 11  | Shaft           |
| 12  | Bearing         |
| 13  | Bearing Cover   |
| 14  | Support Foot    |
| 15  | Packing Sleeve  |
| 16  | Seal Cage       |
| 17  | Gland Packing   |
| 18  | Gland Cover     |

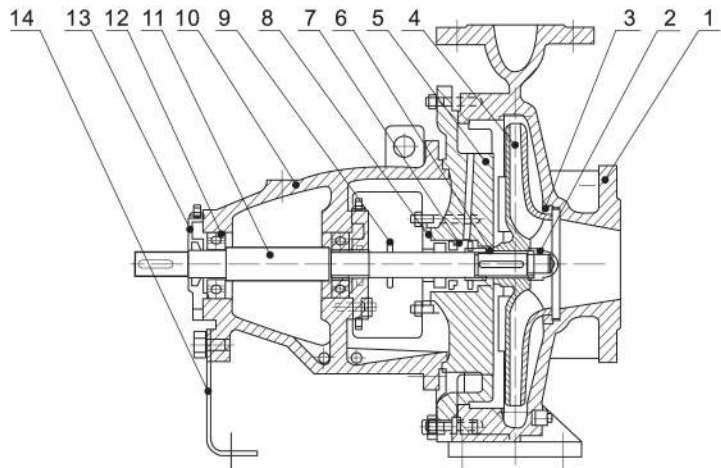
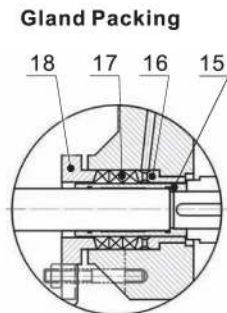



XA Outline Drawing & Installing Dimensions

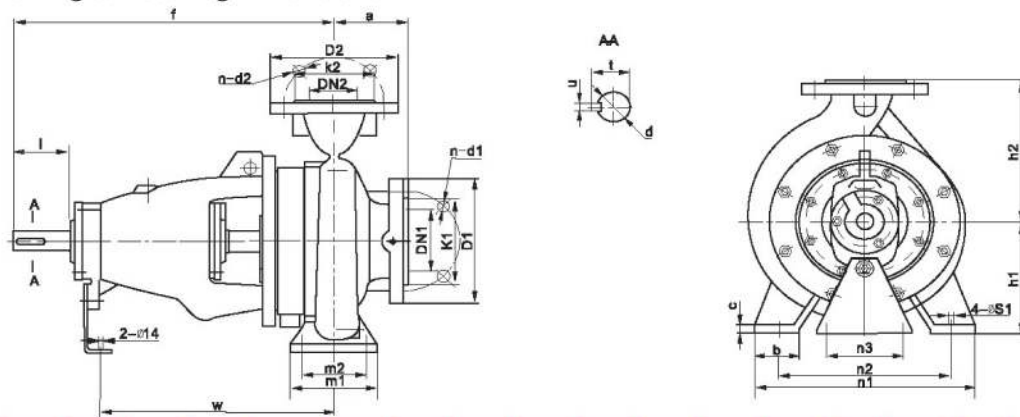

No	Model	Bearing inner Dia.	DN2	DN1	a	f	h1	h2	b	c	n3	m1	m2	n1	n2	S1	w	d	l	t	u
1	XA32/13	25	32	50	80	360	112	140	50	14	100	100	70	190	140	14	267	24	50	27	8
2	XA32/16	25	32	50	80	360	132	160	50	14	100	100	70	240	190	14	267	24	50	27	8
3	XA32/20	25	32	50	80	360	160	180	50	14	110	110	70	240	190	14	267	24	50	27	8
4	XA32/26	25	32	50	100	360	180	225	65	14	110	125	95	320	250	14	267	24	50	27	8
5	XA40/13	25	40	65	80	360	112	140	50	14	100	100	70	210	160	14	267	24	50	27	8
6	XA40/16	25	40	65	80	360	132	160	50	14	100	100	70	240	190	14	267	24	50	27	8
7	XA40/20	25	40	65	100	360	160	180	50	14	110	100	70	265	212	14	267	24	50	27	8
8	XA40/26	25	40	65	100	360	180	225	65	14	110	125	95	320	250	14	267	24	50	27	8
9	XA40/32	35	40	65	125	470	200	250	65	14	110	125	95	345	280	14	342	32	80	35	10
10	XA40/32H	35	40	65	125	470	200	250	65	14	110	125	95	345	280	14	342	32	80	35	10
11	XA40/32G	45	40	65	125	526	200	250	65	14	110	125	95	345	280	14	267	42	110	45	12
12	XA50/13	25	50	65	100	360	132	160	50	14	100	100	70	240	190	14	267	24	50	27	8
13	XA50/13	25	50	65	100	360	160	180	50	14	110	100	70	265	212	14	267	24	50	27	8
14	XA50/20	25	50	65	100	360	160	200	50	14	110	100	70	265	212	14	267	24	50	27	8
15	XA50/26	25	50	65	100	360	180	225	65	14	110	125	95	320	250	14	267	24	50	27	8
16	XA50/26G	35	50	65	100	470	180	225	65	14	110	125	95	320	250	14	344	32	80	35	10
17	XA50/32	35	50	65	125	470	225	280	65	18	110	125	95	345	280	14	342	32	80	35	10
18	XA50/32H	35	50	65	125	470	225	280	65	18	110	125	95	345	280	14	342	32	80	35	10
19	XA50/32G	45	50	65	125	526	225	280	65	18	110	125	95	345	280	14	367	42	110	45	12
20	XA65/13	25	65	80	100	360	160	180	65	14	110	125	95	280	212	14	267	24	50	27	8
21	XA65/16	25	65	80	100	360	160	200	65	14	110	125	95	280	212	14	267	24	50	27	8
22	XA65/20	25	65	80	100	360	180	225	65	14	110	125	95	320	250	14	267	24	50	27	8
23	XA65/20G	35	65	80	100	465	180	225	65	14	110	125	95	320	250	14	339	32	80	35	10
24	XA65/26	35	65	80	100	470	200	250	80	15	110	160	120	360	260	18	342	32	80	35	10
25	XA65/32	35	65	80	125	470	225	280	80	15	110	160	120	400	315	18	342	32	80	35	10
26	XA65/32H	35	65	80	125	470	225	280	80	15	110	160	120	400	315	18	342	32	80	35	10
27	XA65/32G	45	65	80	125	525	225	280	80	18	110	160	120	400	315	18	367	42	110	45	12
28	XA80/16	25	80	100	125	360	180	225	65	65	110	125	95	320	250	14	267	24	50	27	8
29	XA80/20	35	80	100	125	470	180	250	65	65	110	125	95	345	280	14	342	32	80	35	10
30	XA80/26	35	80	100	125	470	200	280	80	15	110	160	120	400	315	18	342	32	80	35	10
31	XA80/32	35	80	100	125	470	250	315	80	16	110	160	120	400	315	18	342	32	80	35	10
32	XA80/32H	35	80	100	125	470	250	315	80	16	110	160	120	400	315	18	342	32	80	35	10
33	XA80/32G	45	80	100	125	526	250	315	80	16	110	160	120	400	315	18	367	42	110	45	12
34	XA80/40	45	80	100	125	530	280	355	83	18	110	160	120	440	340	18	370	42	110	45	12
35	XA100/16	35	100	125	125	470	200	250	80	15	110	160	120	360	280	18	342	32	80	35	10
36	XA100/20	35	100	125	125	470	200	280	80	16	110	160	120	360	280	18	342	32	80	35	10
37	XA100/26	35	100	125	140	470	225	280	80	16	110	160	120	400	315	18	342	32	80	35	10
38	XA100/32	35	100	125	140	470	250	315	80	16	110	160	120	400	315	18	342	32	80	35	10
39	XA100/40	45	100	125	140	530	280	355	100	20	110	200	150	500	400	23	370	42	110	45	12
40	XA125/20	35	125	150	140	470	250	315	80	16	110	160	120	400	315	18	342	32	80	35	10
41	XA125/32	35	125	150	140	470	250	250	80	16	110	160	120	400	315	18	342	32	80	35	10
42	XA125/32	45	125	150	140	530	280	355	100	18	110	200	150	500	400	23	370	42	110	45	12
43	XA125/40	45	125	150	140	530	315	400	100	18	110	200	150	500	400	23	370	42	110	45	12
44	XA125/50	55	125	150	160	670	355	450	100	25	110	200	150	550	450	23	500	48	110	51	14
45	XA150/20	35	150	200	160	500	280	400	100	18	110	200	150	400	315	23	342	32	80	35	10
46	XA150/26	45	150	200	160	530	250	355	100	18	110	200	150	450	350	23	370	42	110	45	12
47	XA150/32	45	150	200	160	530	280	400	100	18	110	200	150	550	450	23	370	42	110	45	12
48	XA150/40	45	150	200	160	530	315	450	100	18	110	200	150	550	450	23	370	42	110	45	12
49	XA150/50	55	150	200	180	670	375	500	100	22	110	200	150	550	450	23	500	48	110	51	14
50	XA200/26	45	200	250	180	555	315	450	120	20	110	200	150	550	450	28	392	42	110	45	12
51	XA200/32	55	200	250	180	670	315	480	120	20	110	220	170	600	480	28	505	48	110	51	14
52	XA200/32	55	200	250	180	670	335	480	150	20	110	220	170	600	480	28	505	48	110	51	14
53	XA250/32	55	250	300	220	691	355	520	150	26	110	250	200	660	510	28	525	48	110	51	14
54	XA250/40	55	250	300	220	682	400	560	150	26	110	250	200	660	510	28	516	48	110	51	14
55	XA200/50	65	200	250	200	720	425	560	100	22	140	200	150	660	560	23	515	60	140	64	18
56	XA250/50	65	250	300	250	720	450	670	120	32	140	240	190	750	650	23	515	60	140	64	18
57	XA300/40	65	300	350	300	720	425	670	120	30	140	250	190	760	660	28	515	60	140	64	18

Flange Standard Dimensions (ISO7005.2 DIN2 501 PN 16 GB/T17241.6 PN1.6)

DN1/DN2	32	40	50	65	80	100	125	150	200	250	300
D1/D2	140	150	165	185	200	220	250	285	340	405	460
K1/K2	100	110	125	145	160	180	210	240	295	355	410
n-d 1/ n-d2	4-φ18	4-φ18	4-φ18	4-φ18	8-φ18	8-φ18	8-φ18	8-φ22	12-φ22	12-φ26	12-φ26



ISO9001:2000

## XA XAD XAZ Series-50Hz Performance

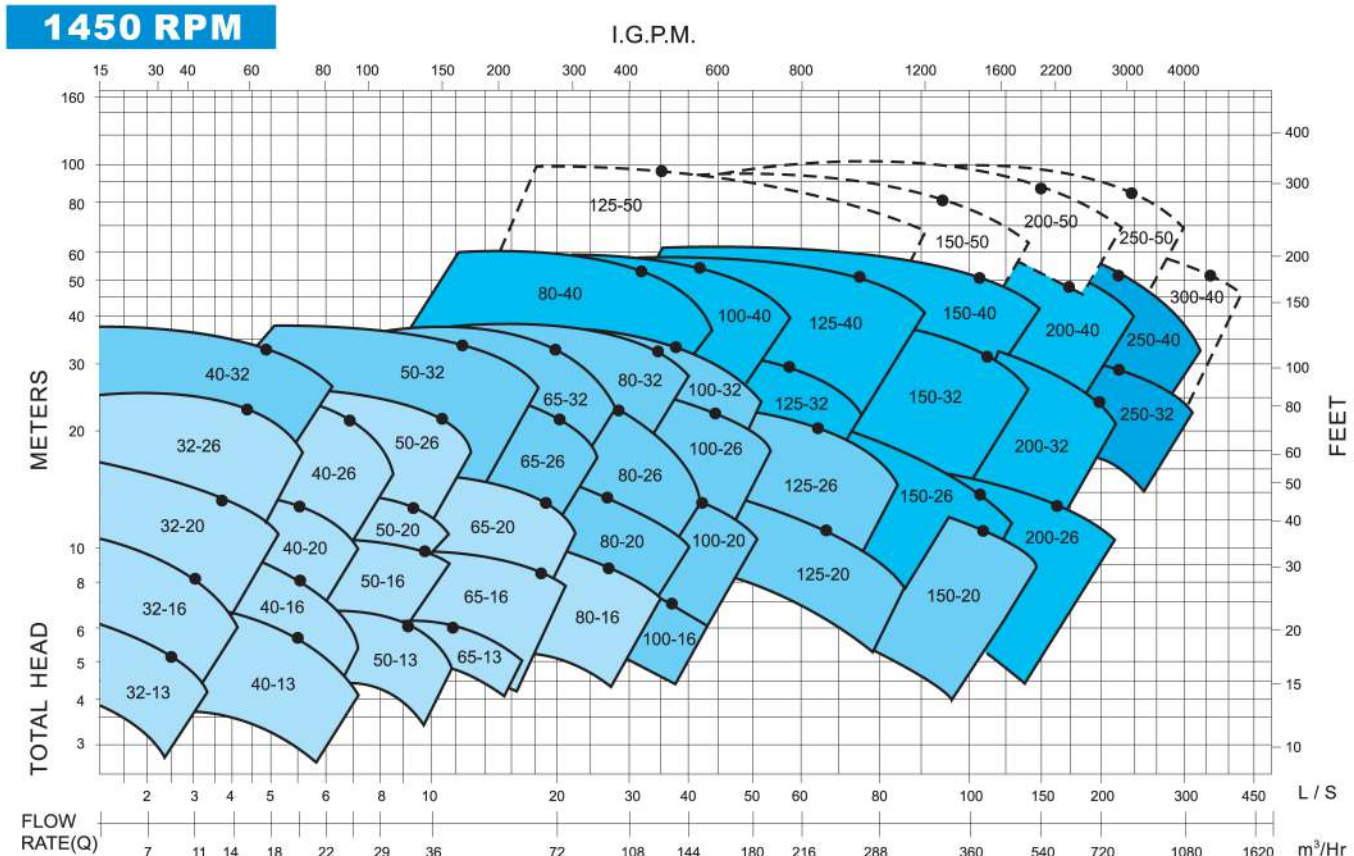
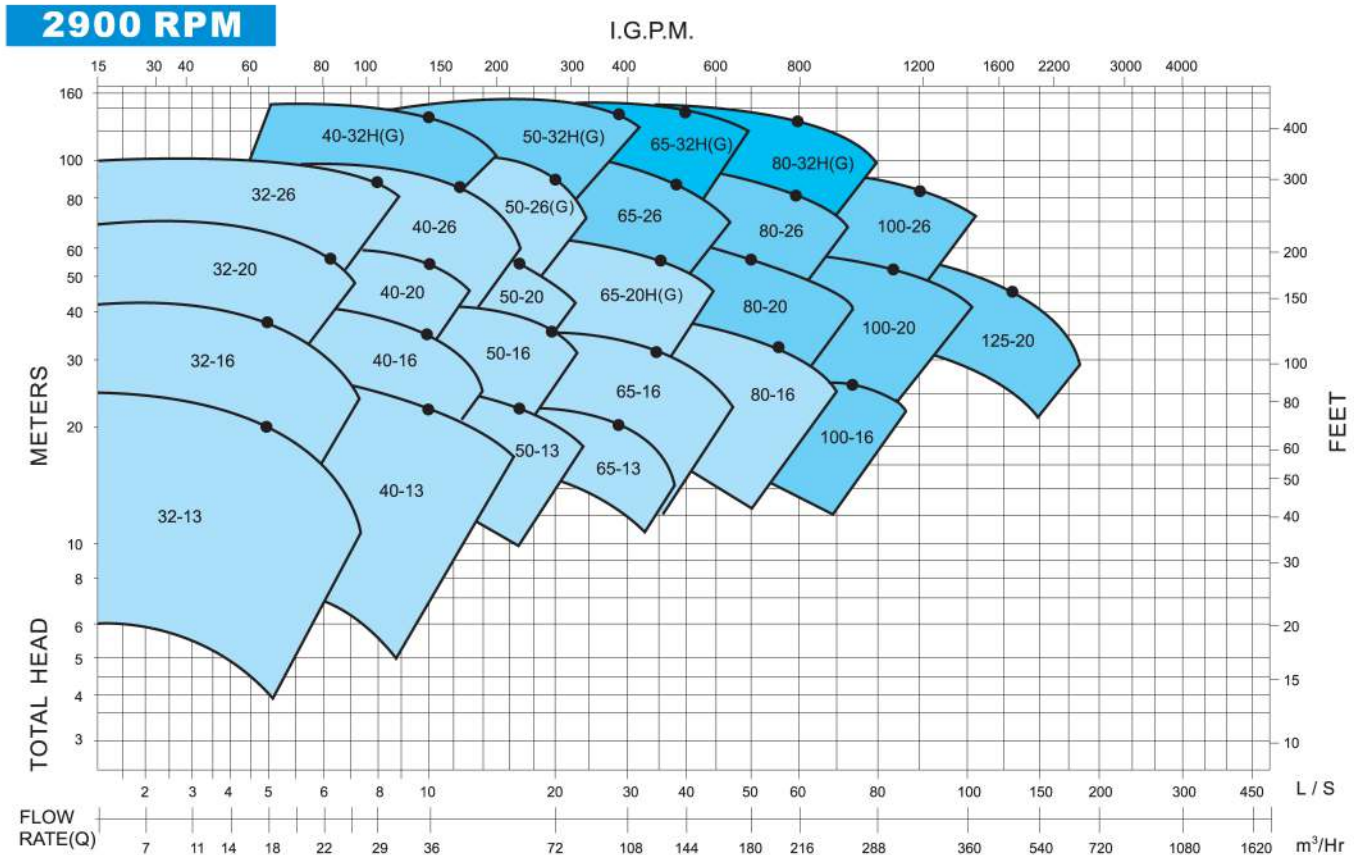



## XA XAD XAZ Series-60Hz Performance

### 3500 RPM

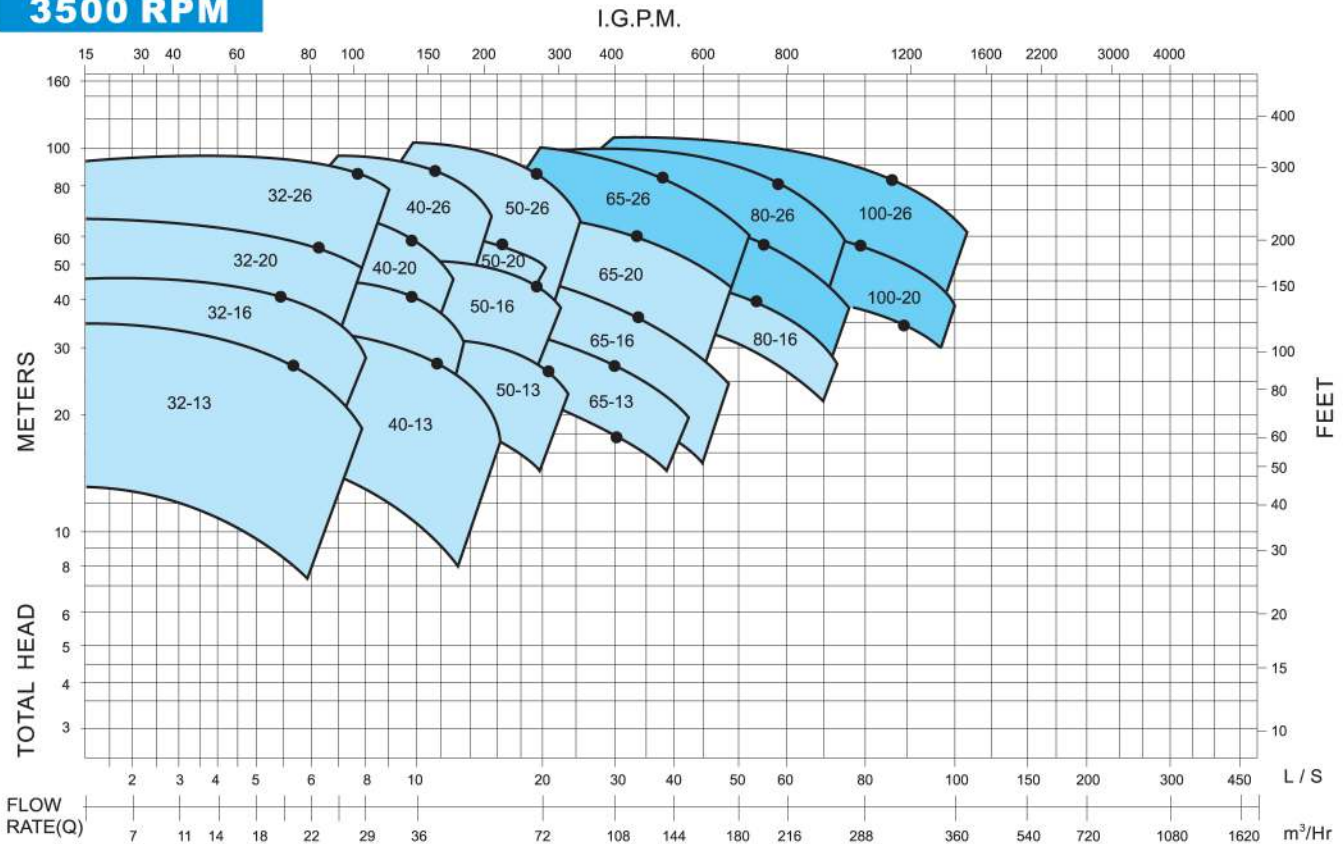

### 1750 RPM

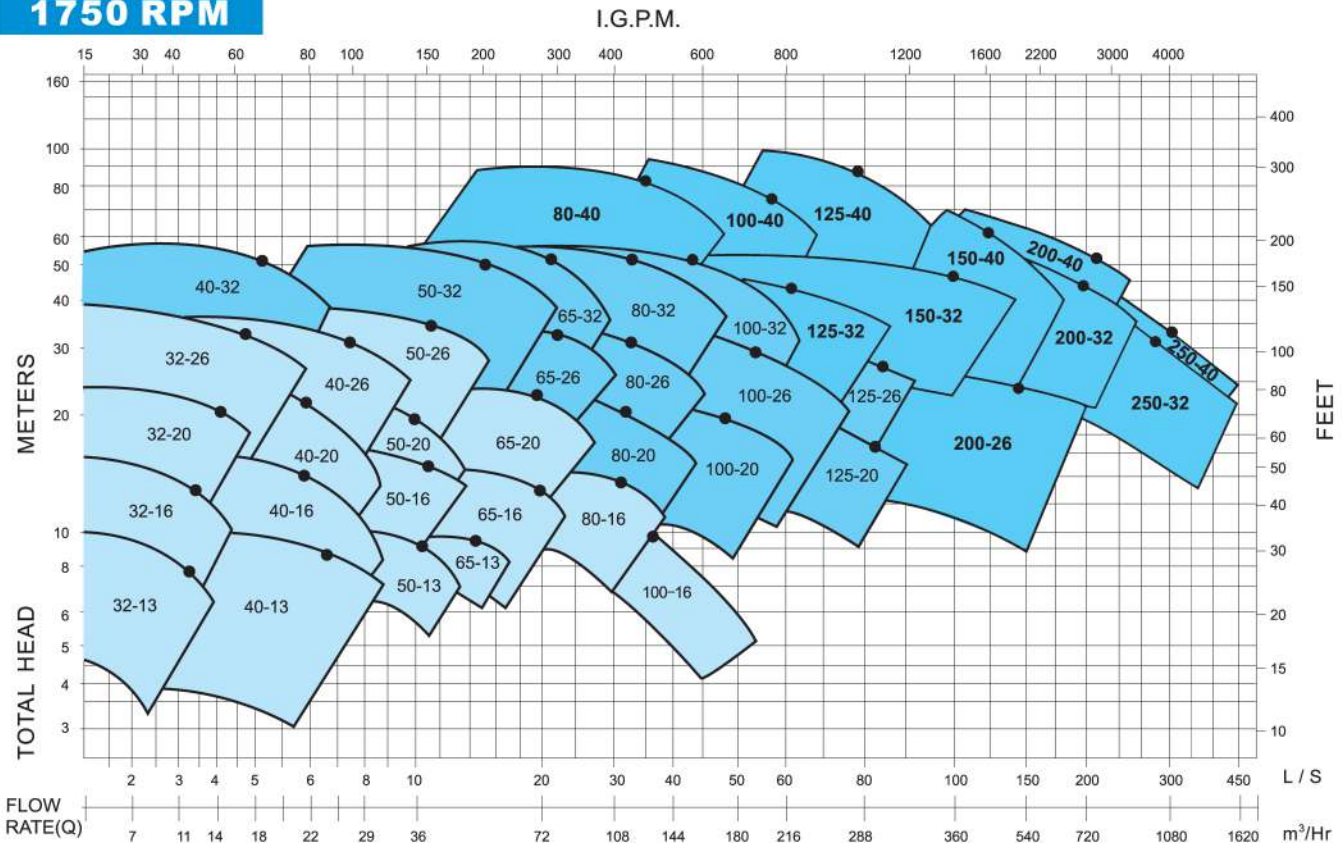

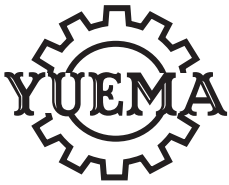

# END SUCTION PUMPS PERFORMANCE CURVES XA SERIES

## XA 32/13-1450RPM (50HZ)

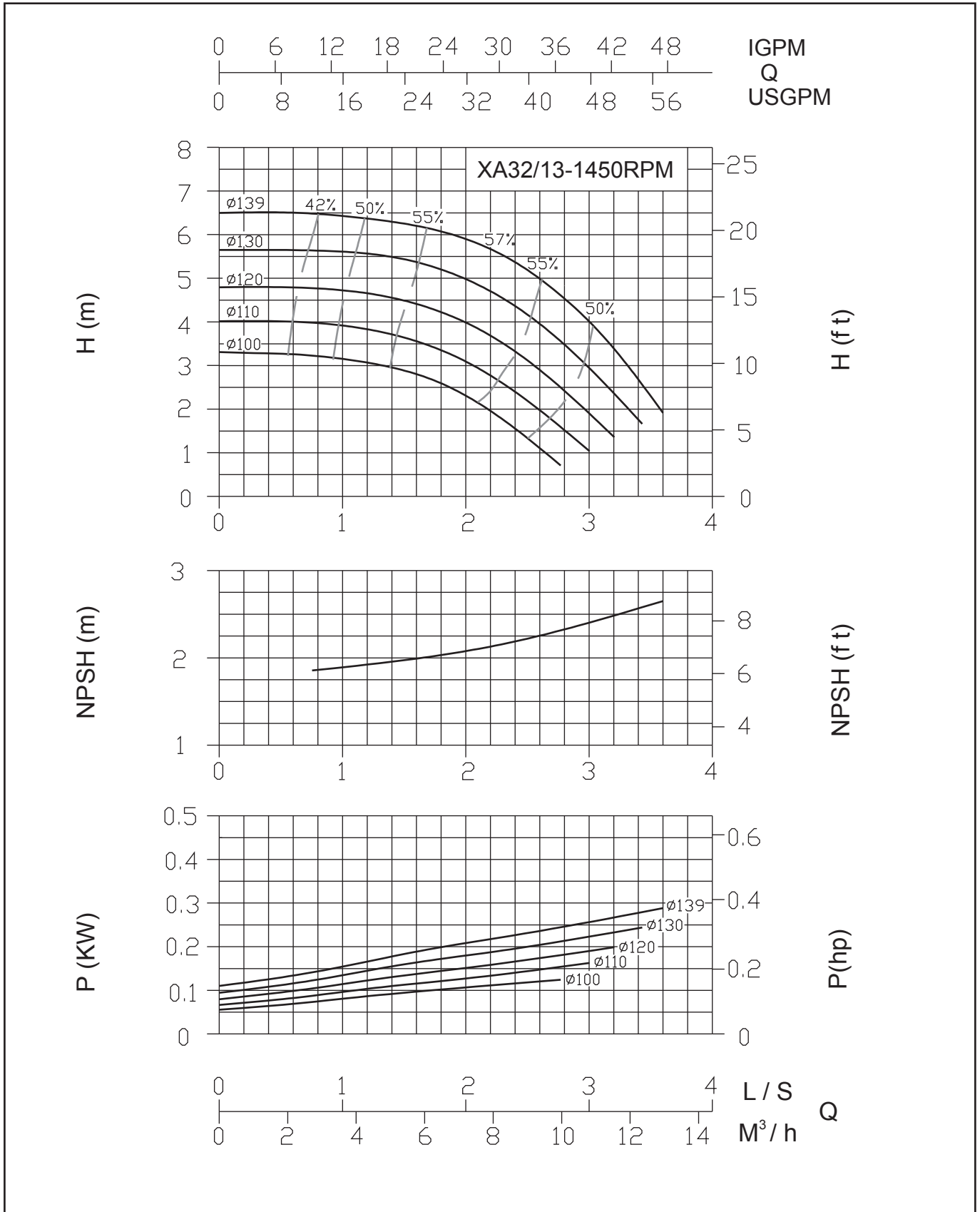

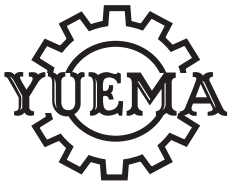

# END SUCTION PUMPS PERFORMANCE CURVES XA SERIES

## XA32/13-1750RPM (60HZ)

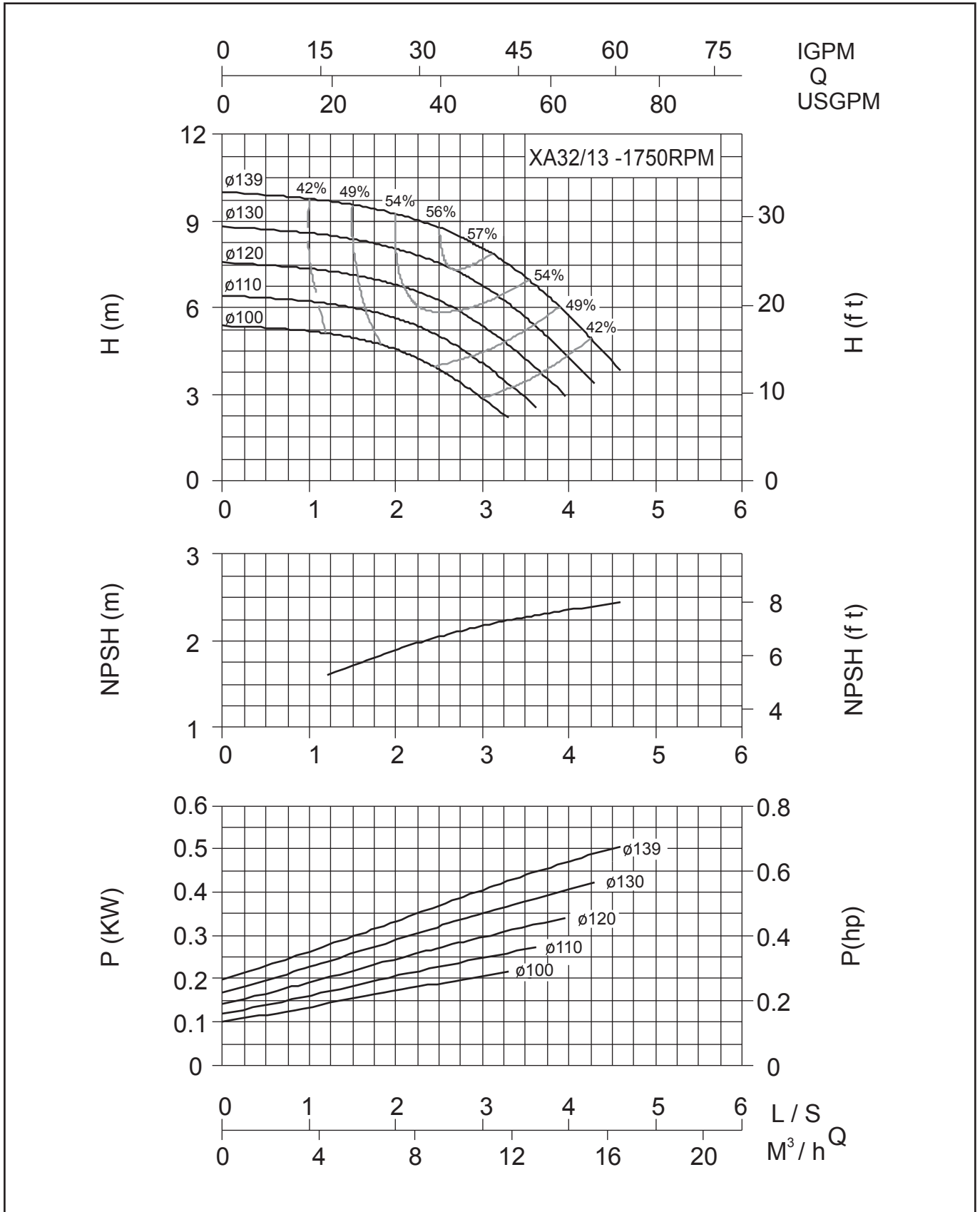



# END SUCTION PUMPS PERFORMANCE CURVES XA SERIES

## XA32/16-1450RPM (50HZ)

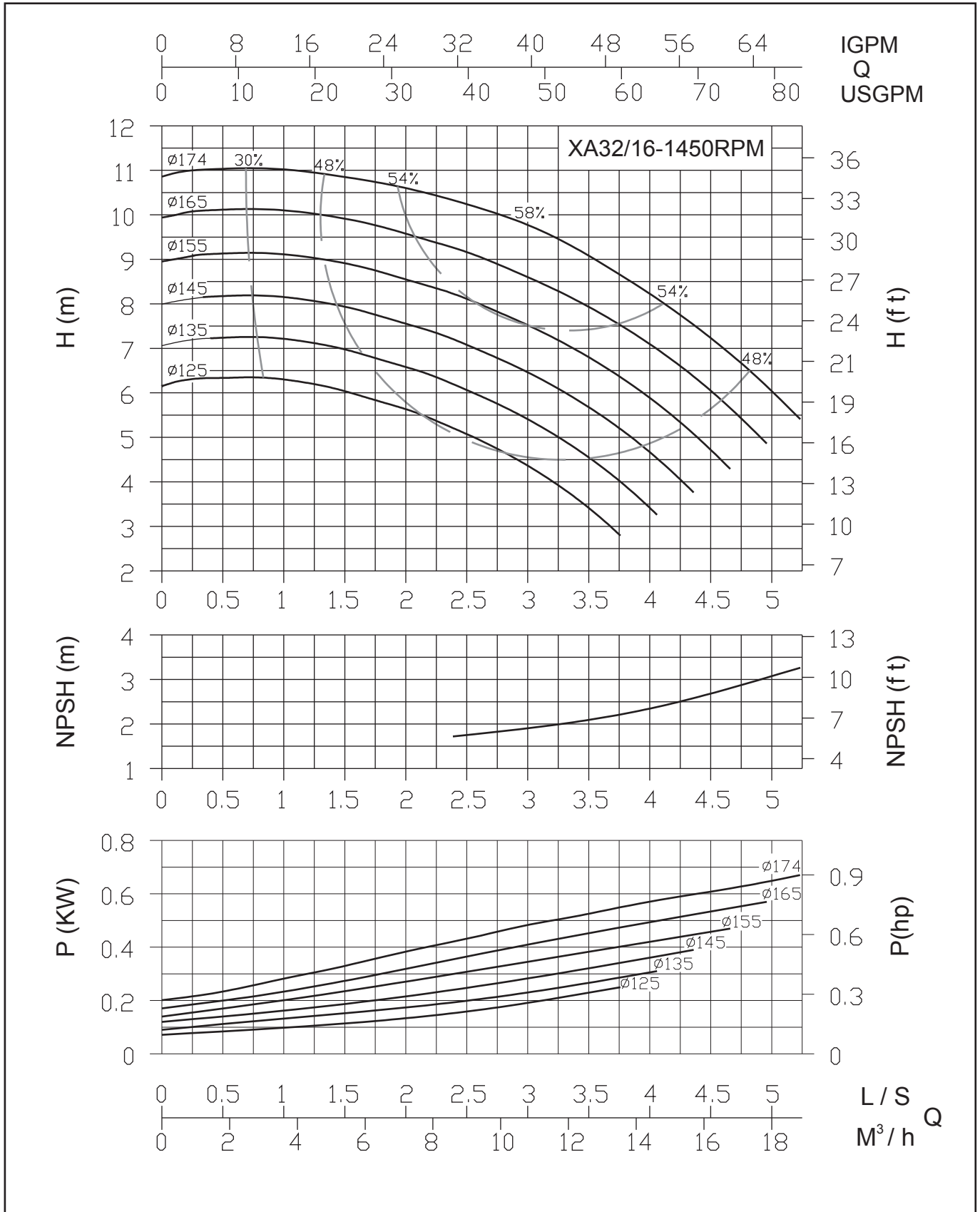



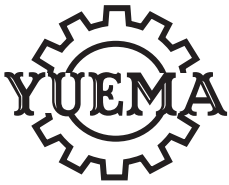

# END SUCTION PUMPS PERFORMANCE CURVES XA SERIES

## XA32/16-1750 (60HZ)

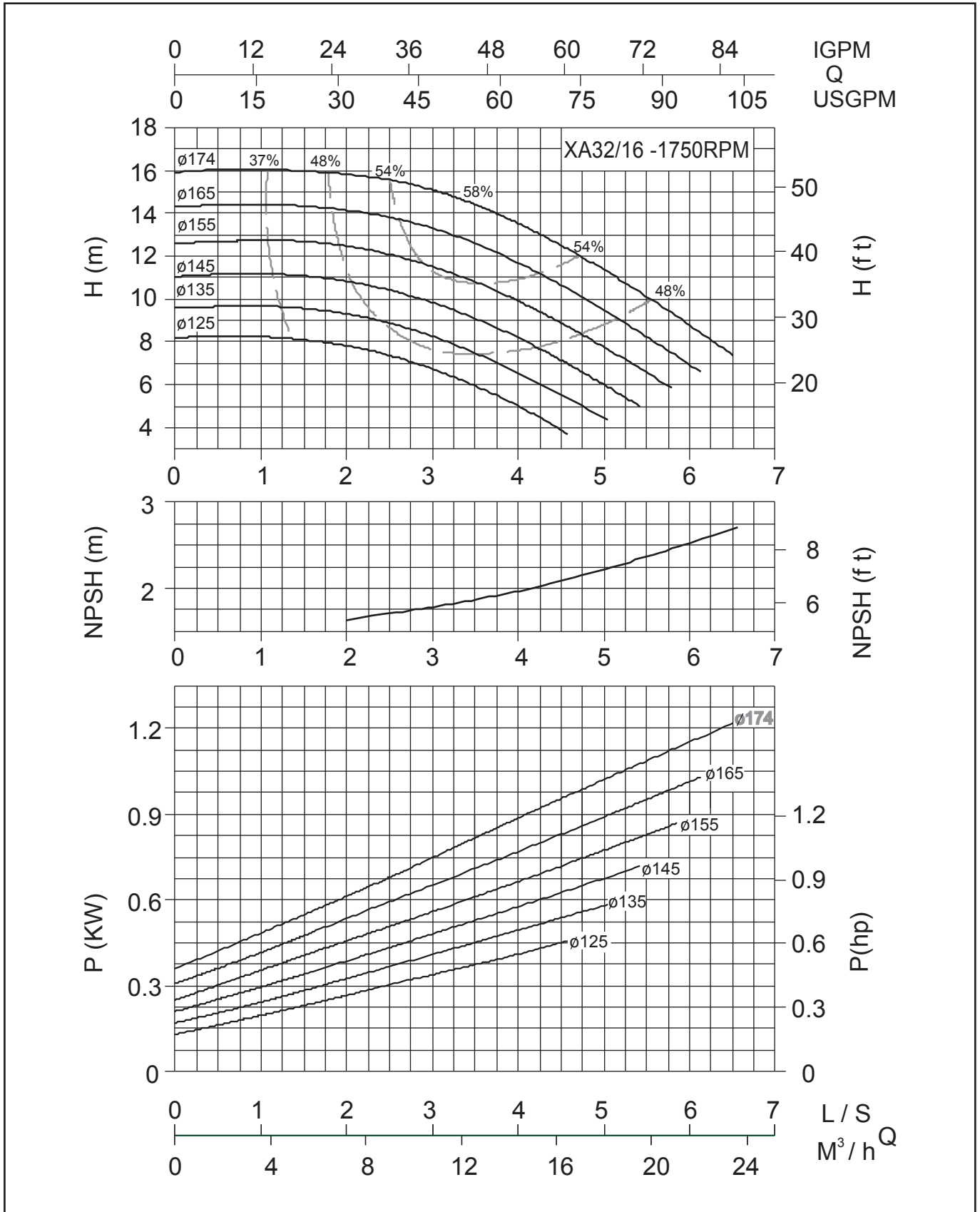



# END SUCTION PUMPS PERFORMANCE CURVES XA SERIES

## XA32/20-1450RPM (50HZ)

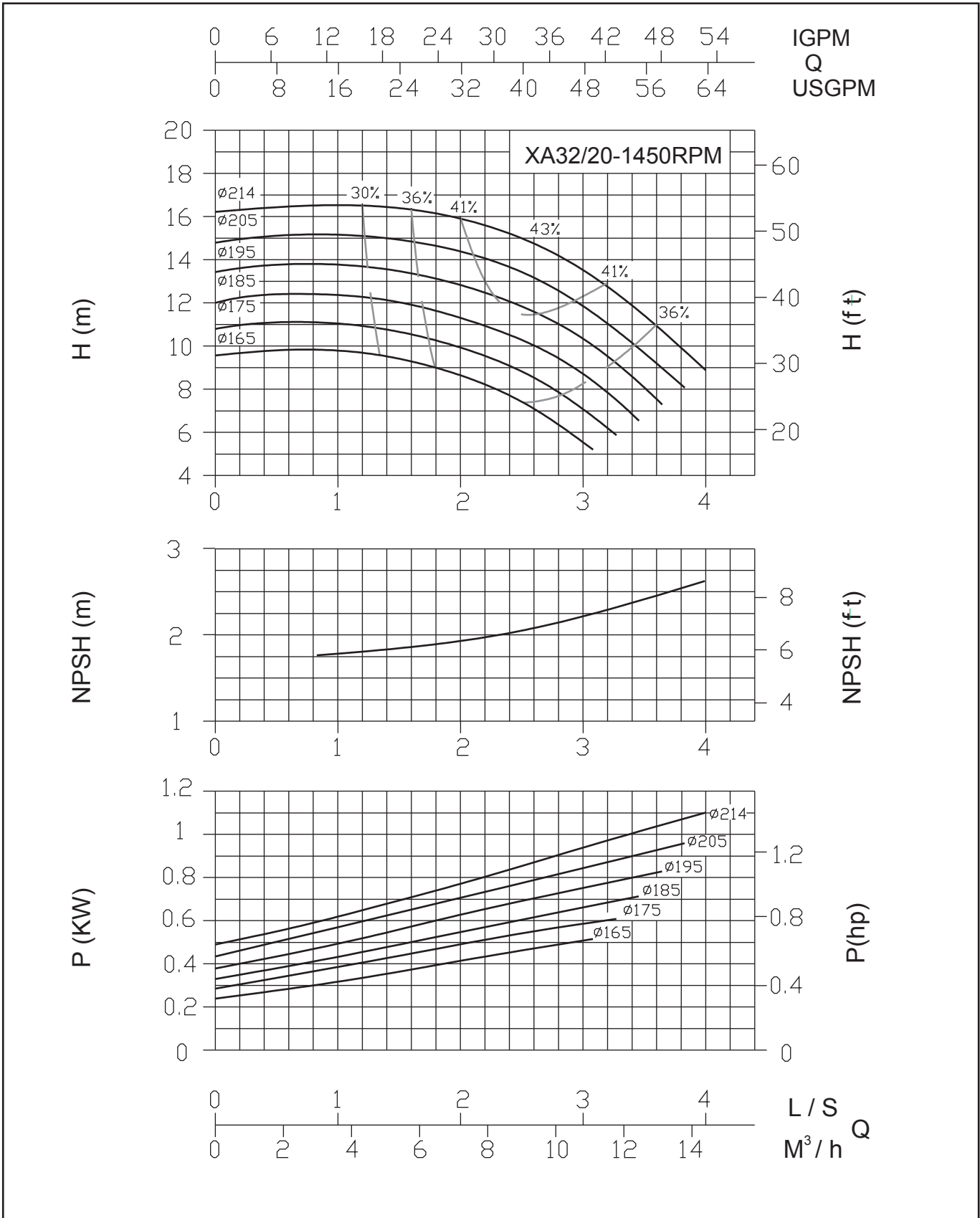

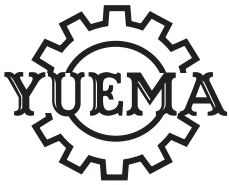

# END SUCTION PUMPS PERFORMANCE CURVES XA SERIES

## XA32/20-1750RPM (60HZ)

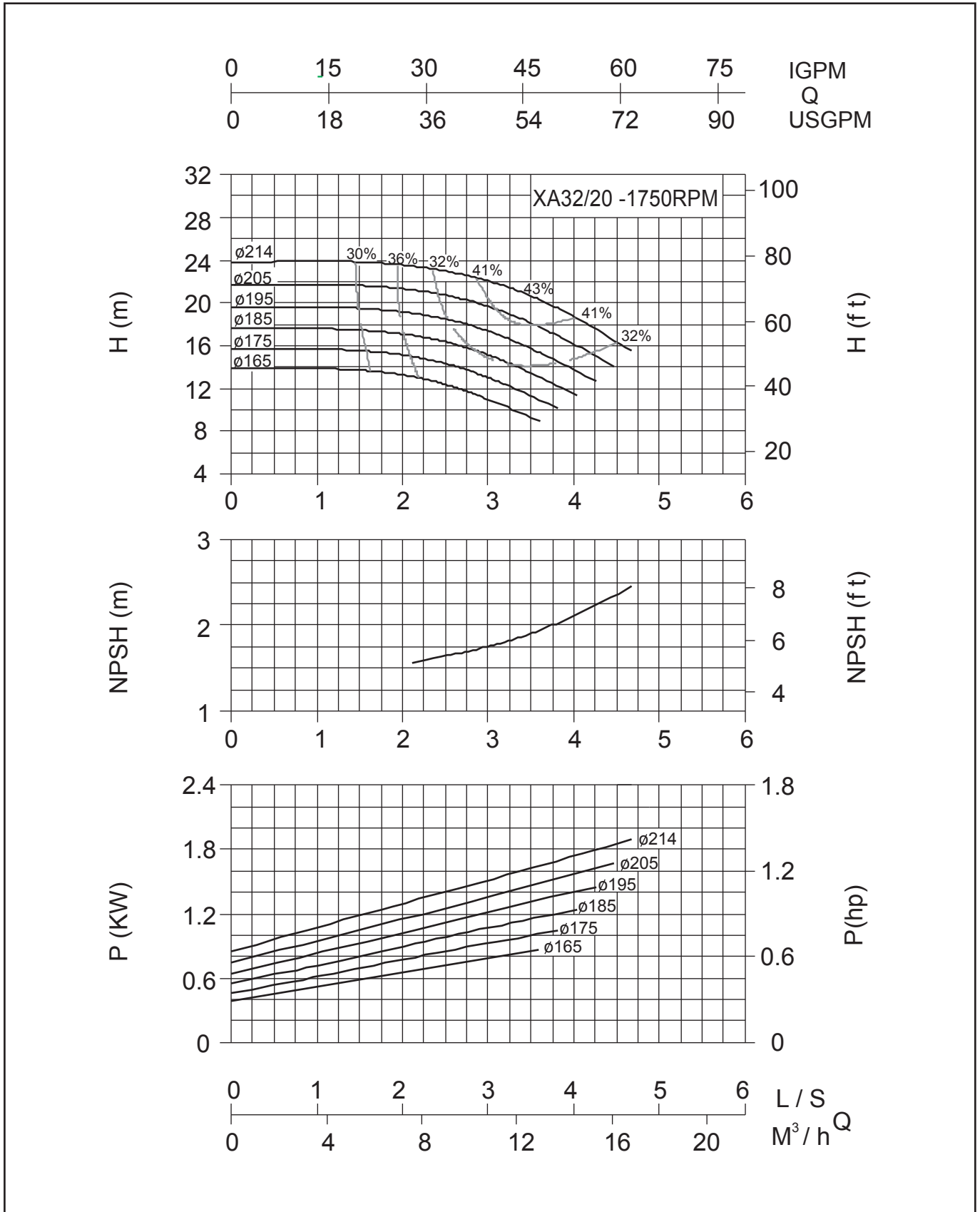



# END SUCTION PUMPS PERFORMANCE CURVES XA SERIES

## XA32/26-1450 (50HZ)

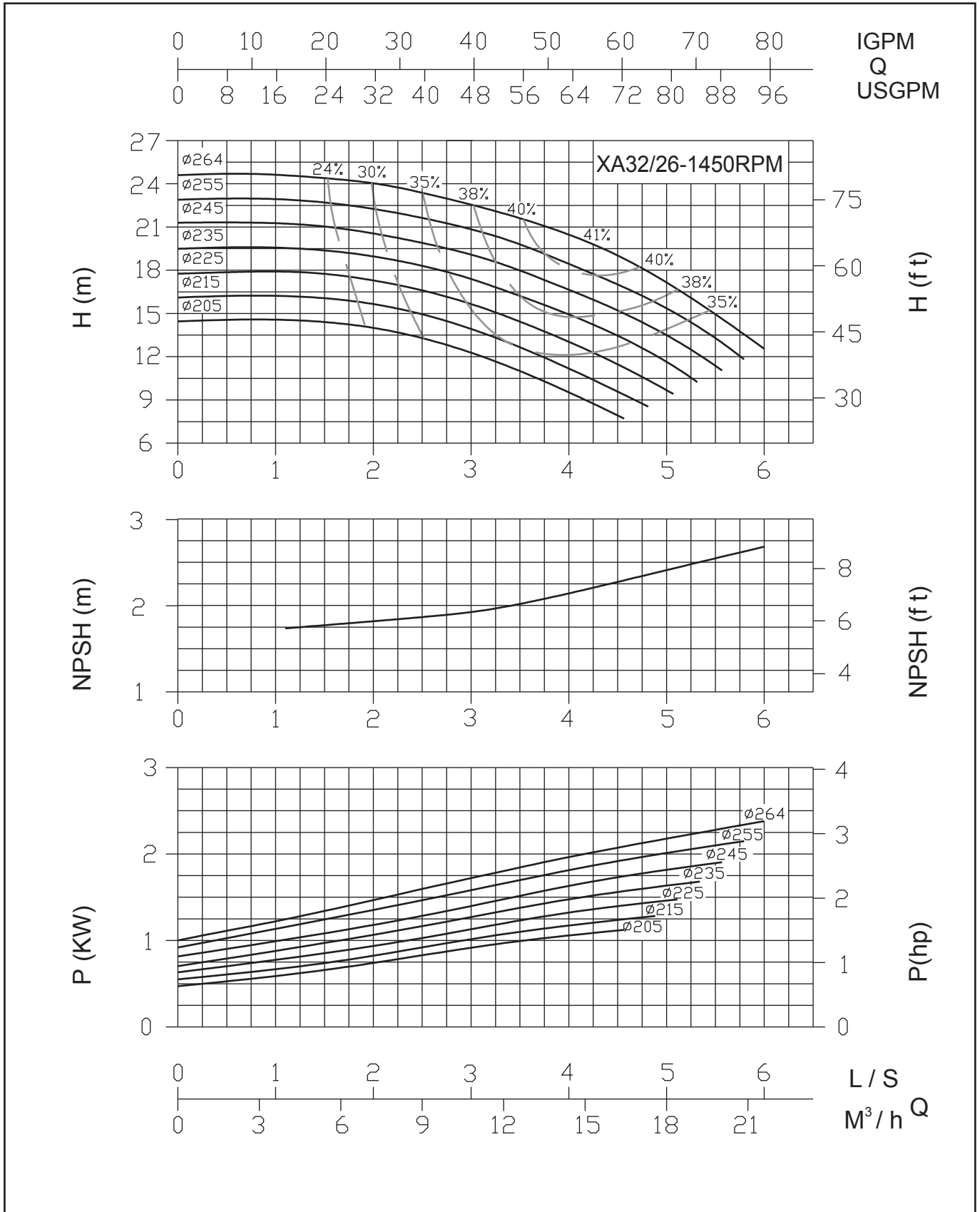

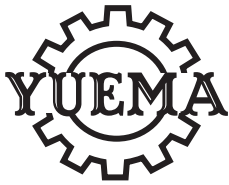

# END SUCTION PUMPS PERFORMANCE CURVES XA SERIES

## XA32/26-1750RPM (60HZ)

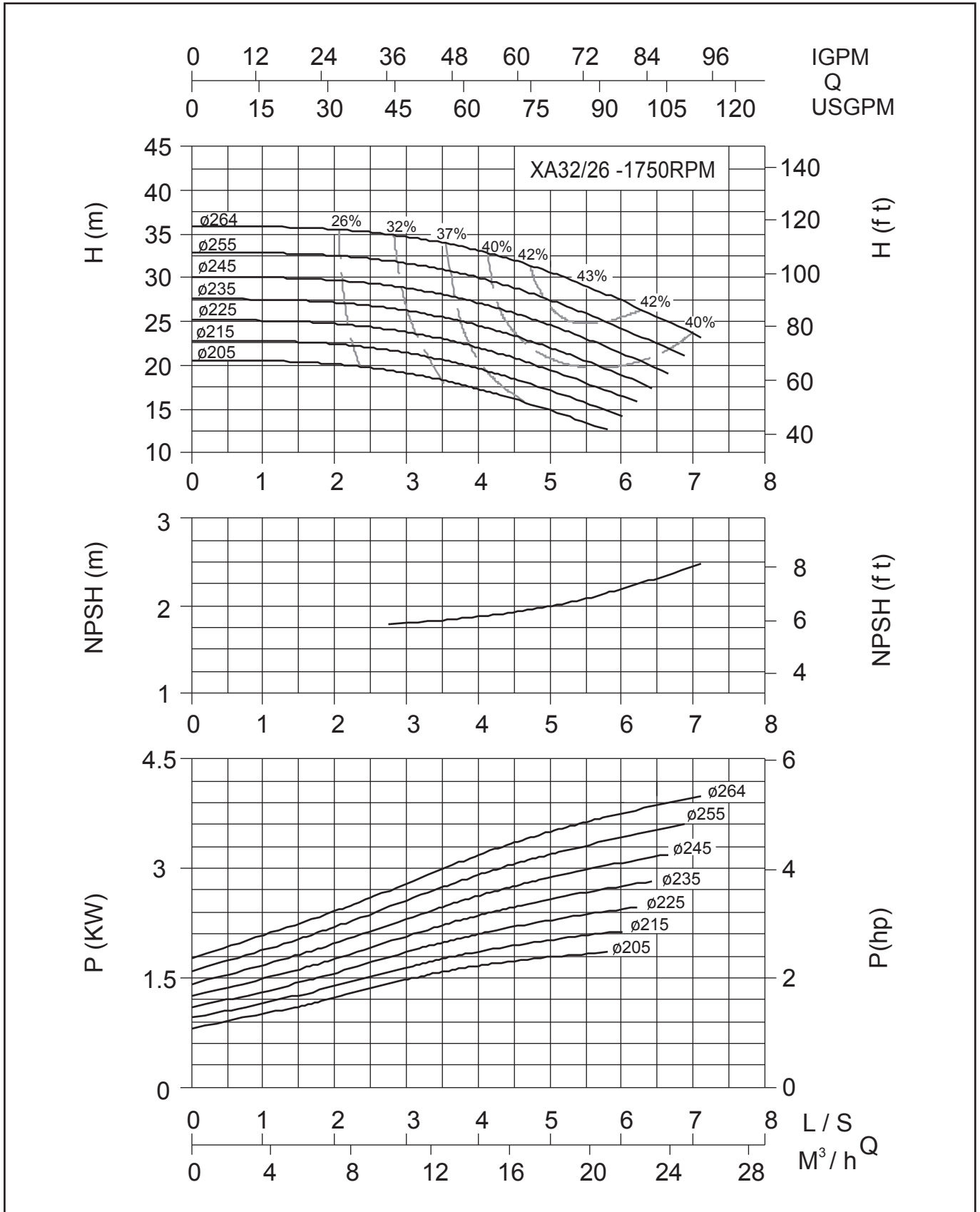



# END SUCTION PUMPS PERFORMANCE CURVES XA SERIES

## XA40/13-1450RPM (50HZ)

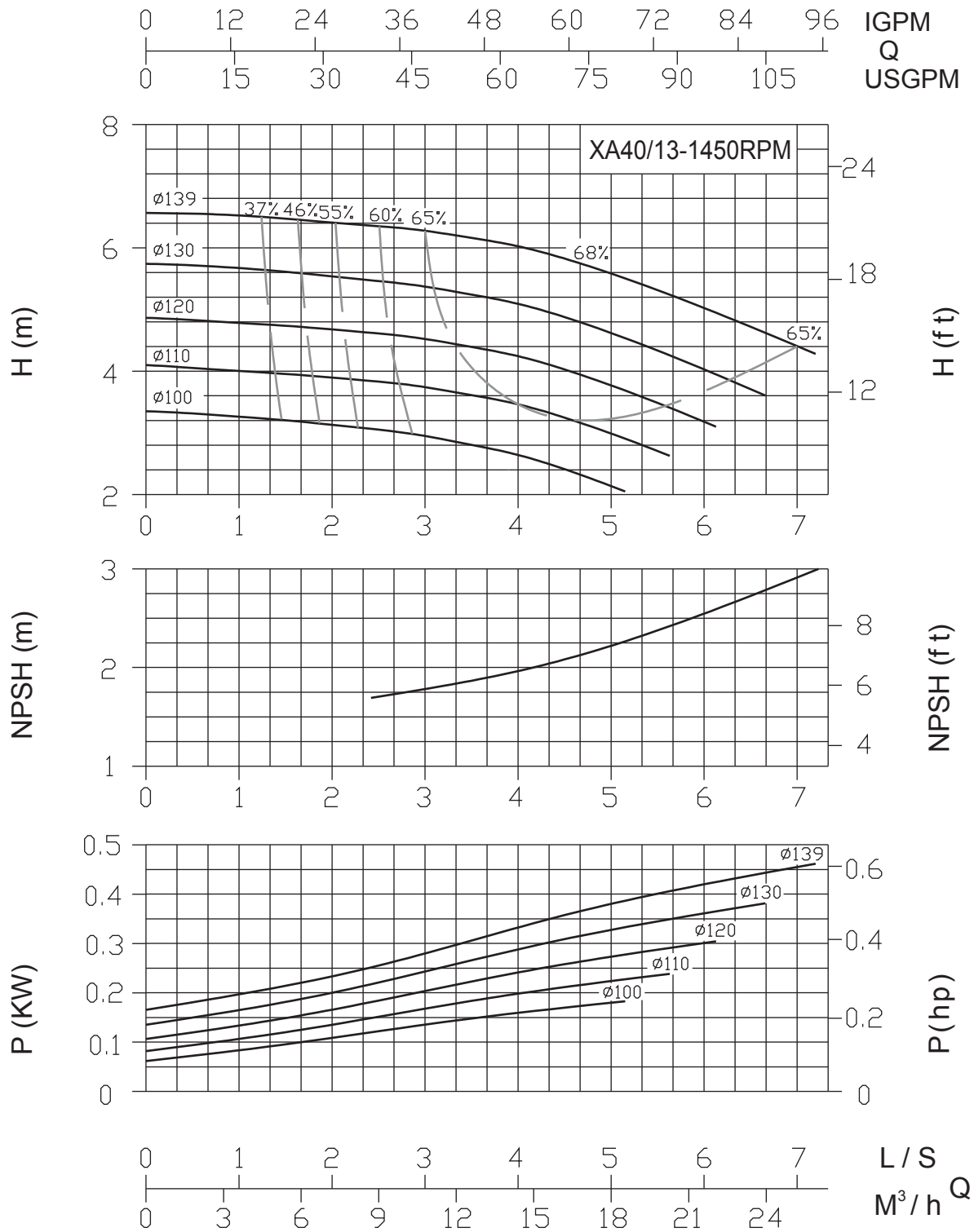



# END SUCTION PUMPS PERFORMANCE CURVES XA SERIES

## XA40/13-1750RPM (60HZ)

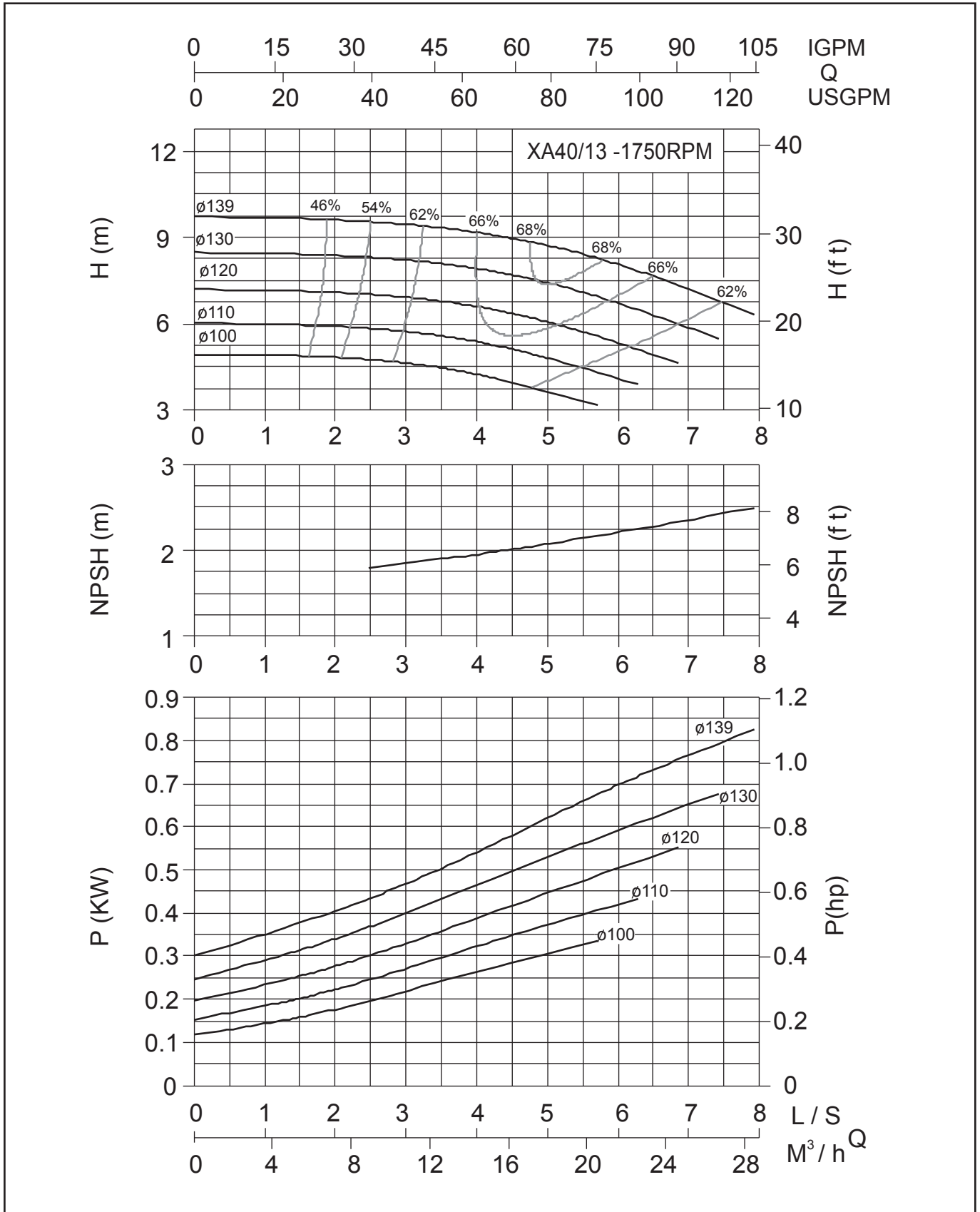



# END SUCTION PUMPS PERFORMANCE CURVES XA SERIES

## XA40/16-1450RPM (50HZ)

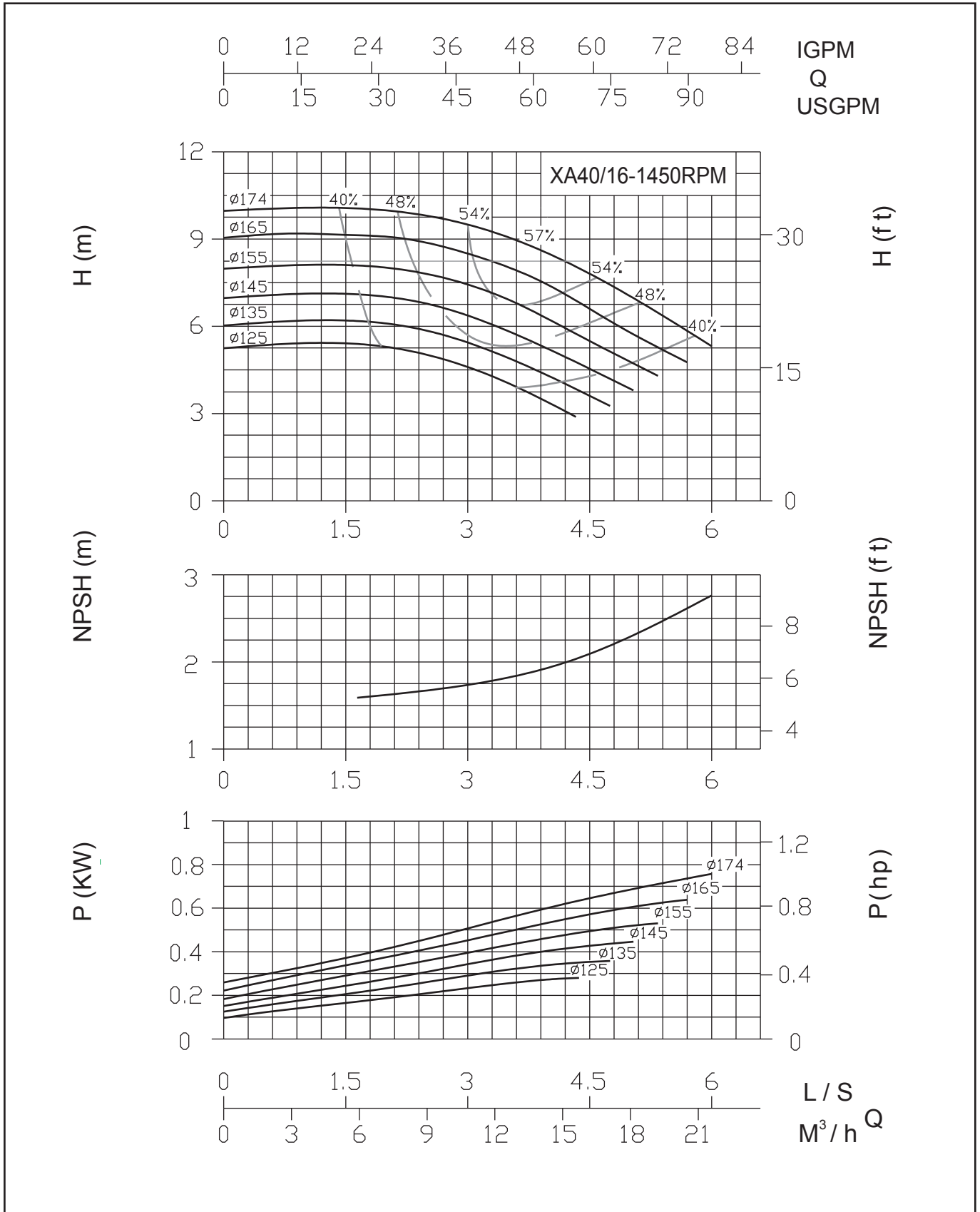



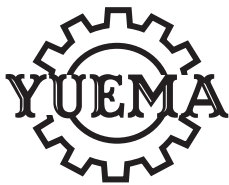

# END SUCTION PUMPS PERFORMANCE CURVES XA SERIES

## XA40/16-1750RPM (60HZ)

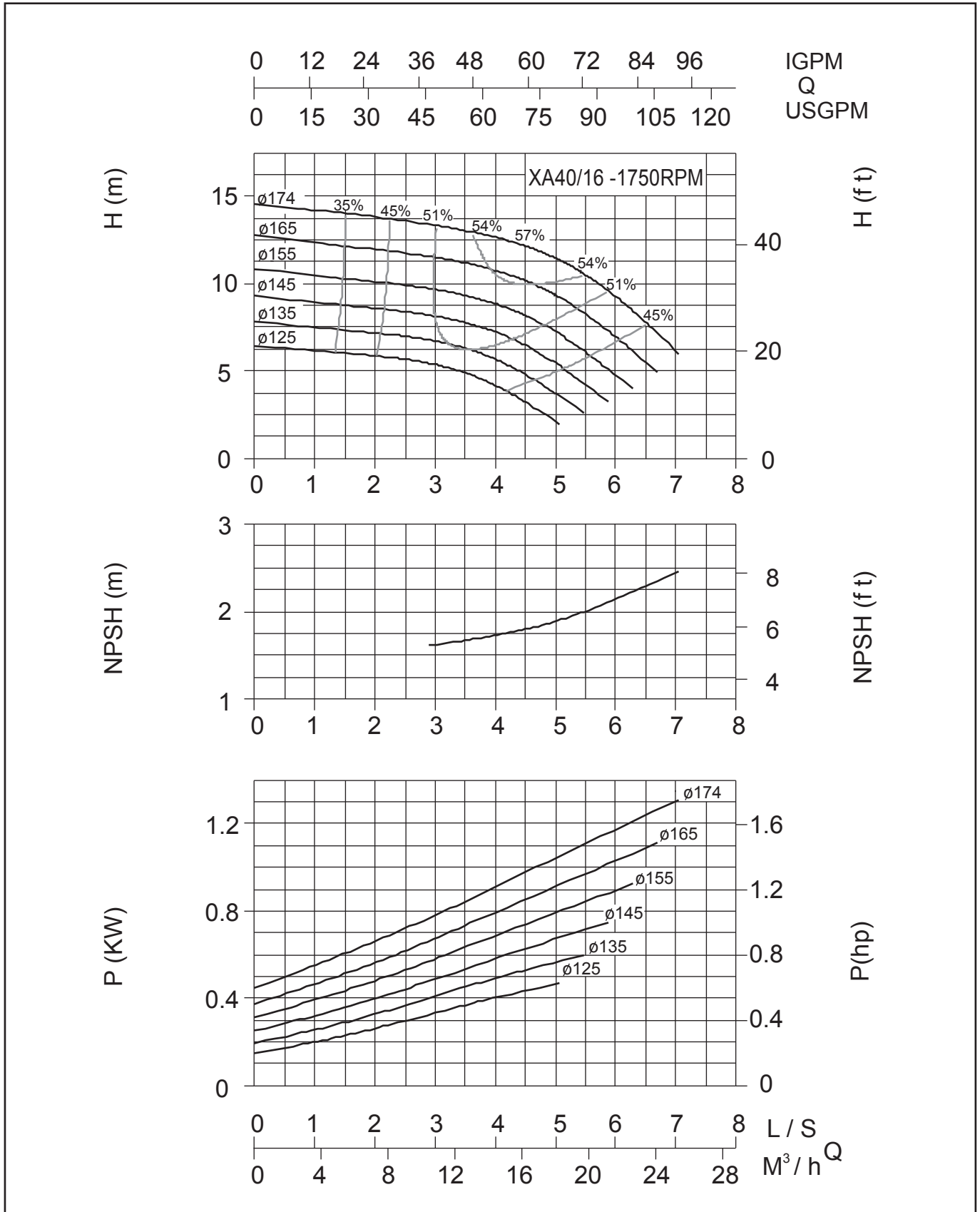



# END SUCTION PUMPS PERFORMANCE CURVES XA SERIES

## XA40/20-1450RPM (50HZ)

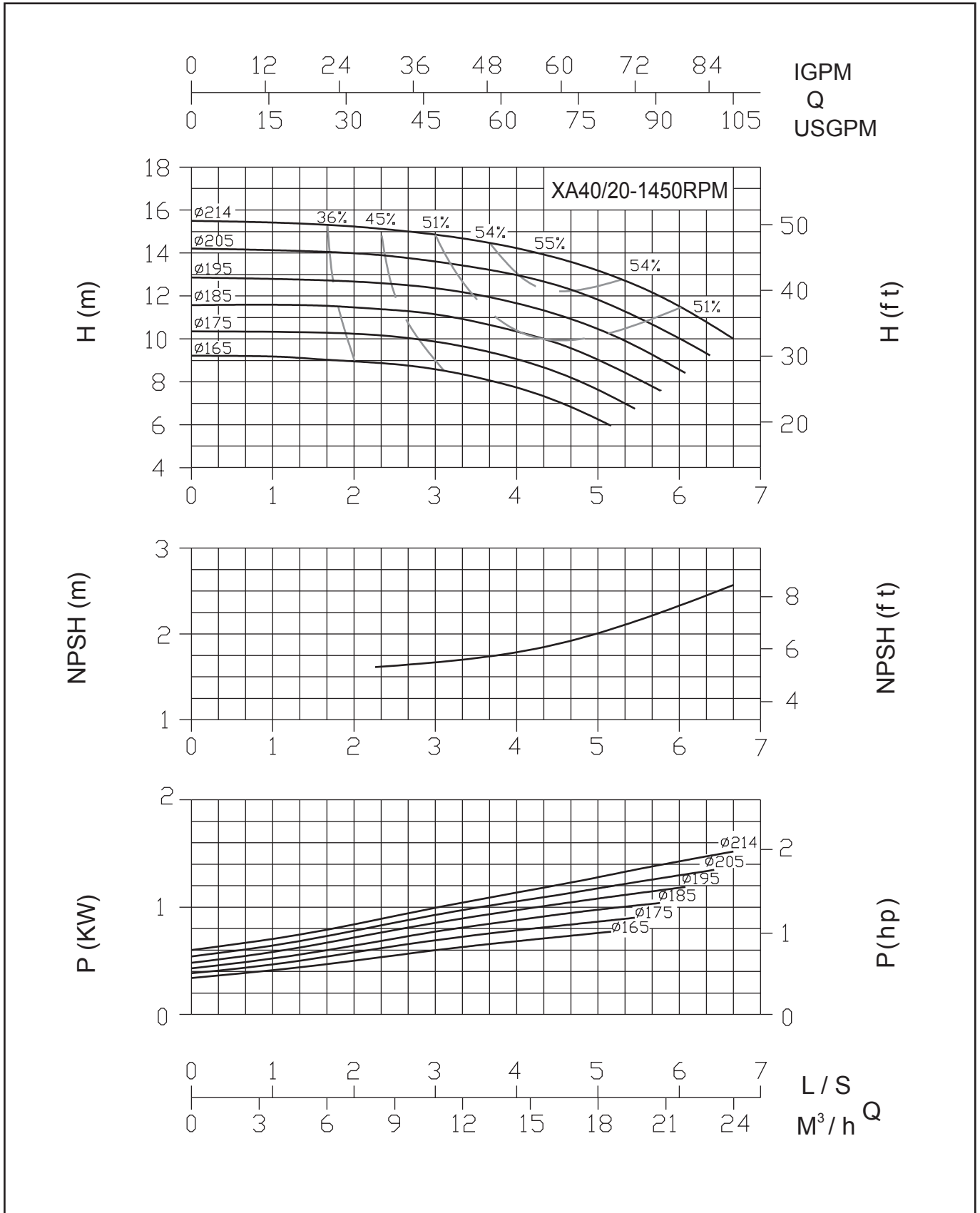



# END SUCTION PUMPS PERFORMANCE CURVES XA SERIES

## XA40/20-1750RPM (60HZ)

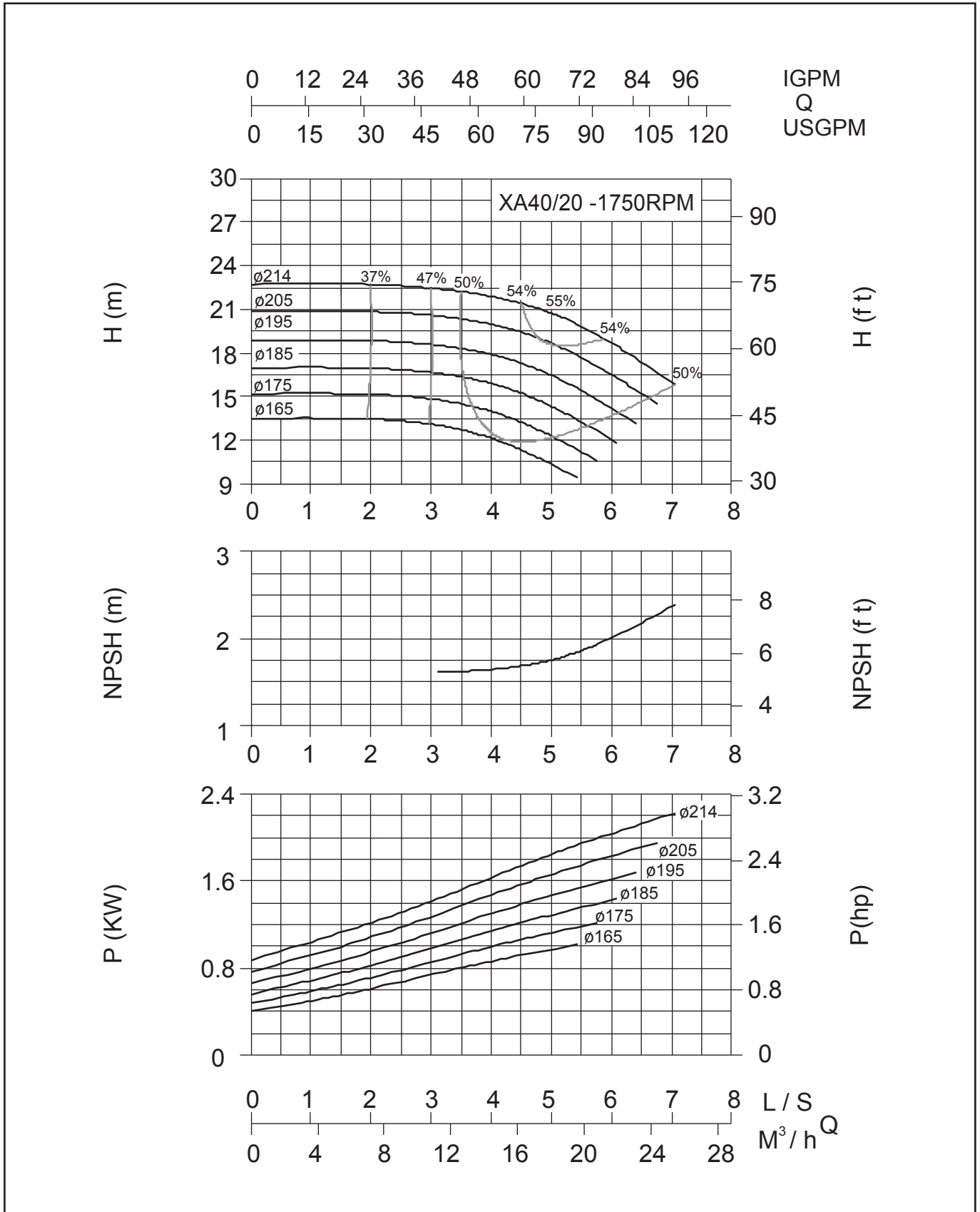



# END SUCTION PUMPS PERFORMANCE CURVES XA SERIES

## XA40/26-1450RPM (50HZ)

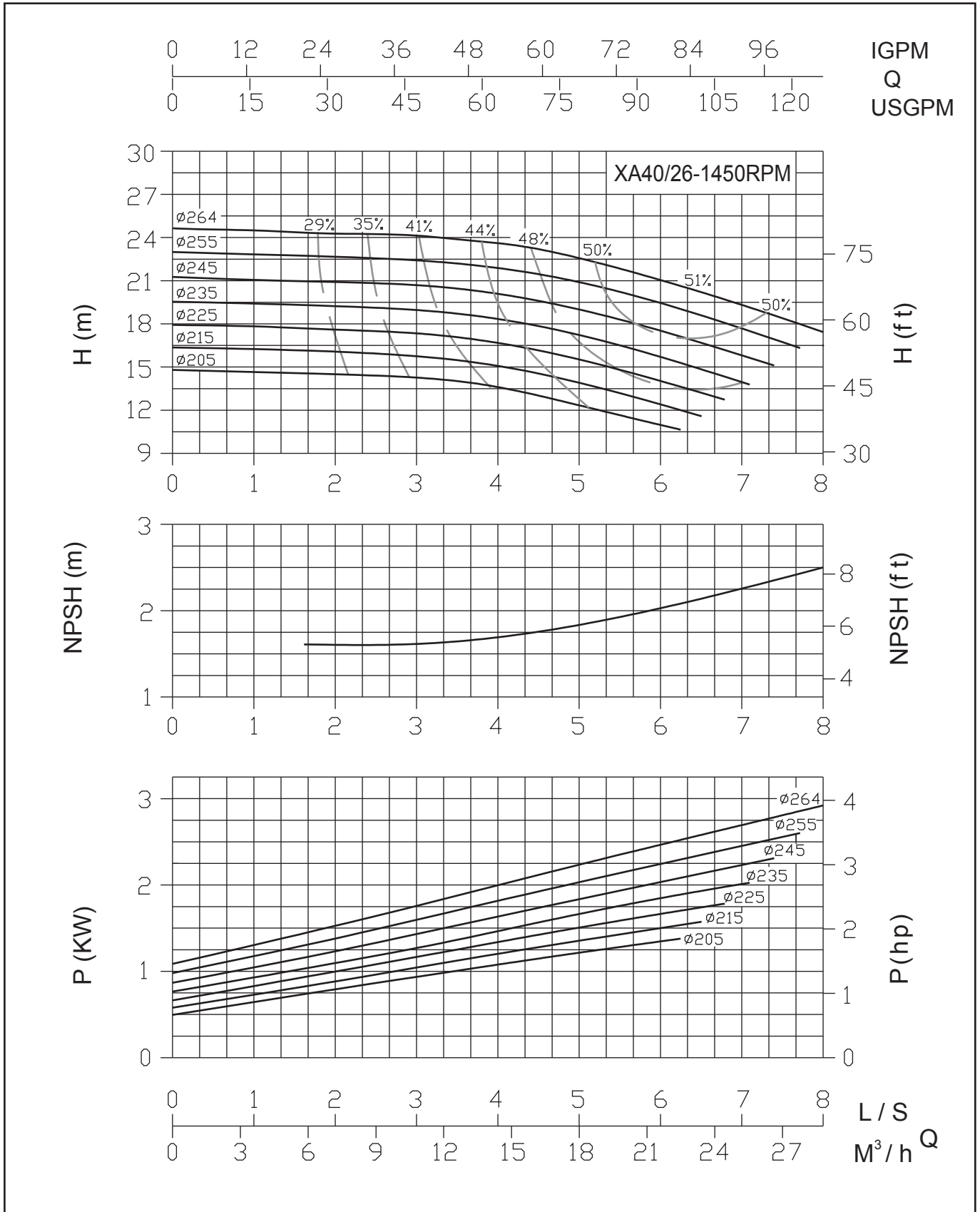

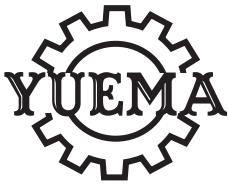

# END SUCTION PUMPS PERFORMANCE CURVES XA SERIES

## XA40/26-1750RPM (60HZ)

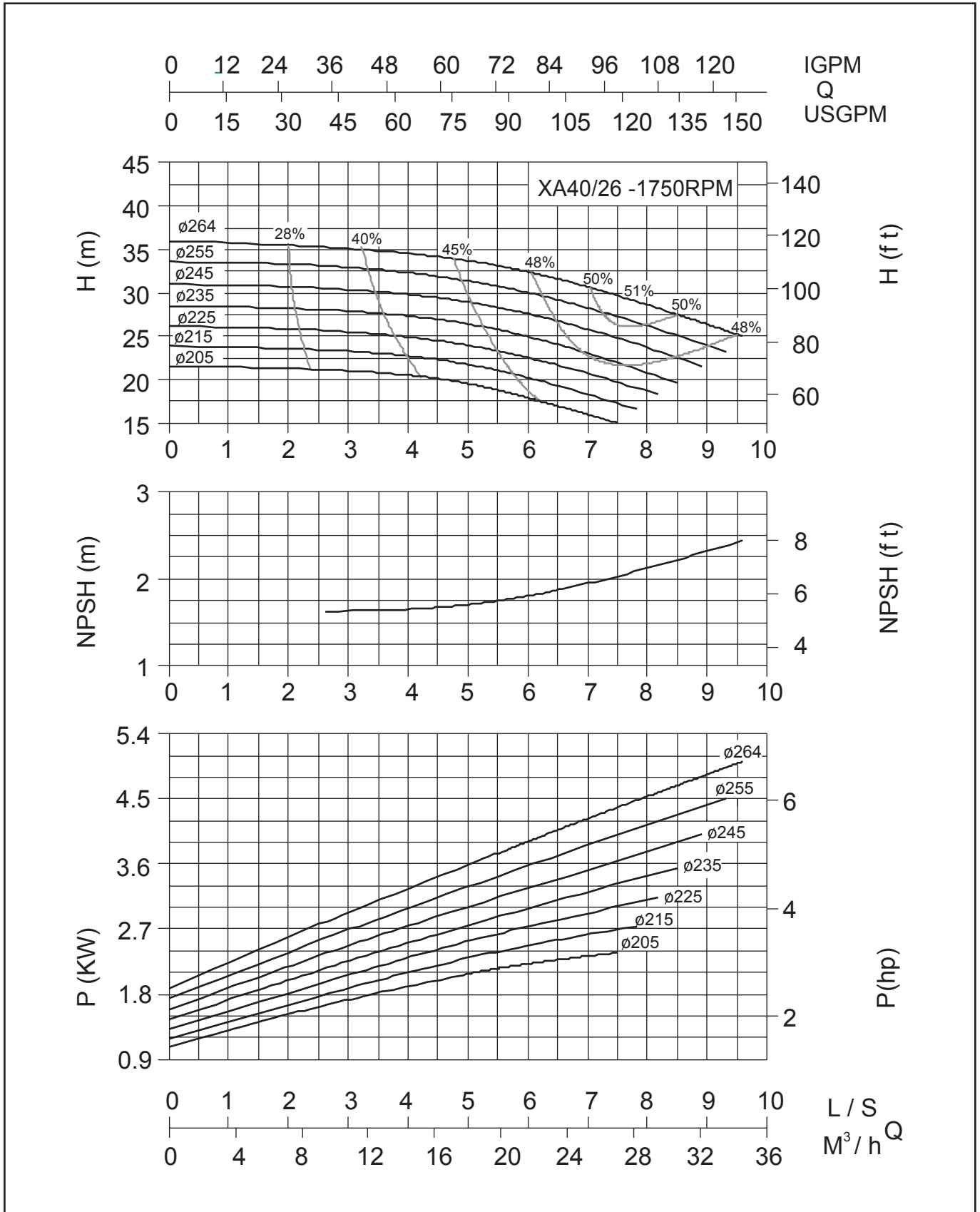



# END SUCTION PUMPS PERFORMANCE CURVES XA SERIES

## XA40/32-1450RPM (50HZ)

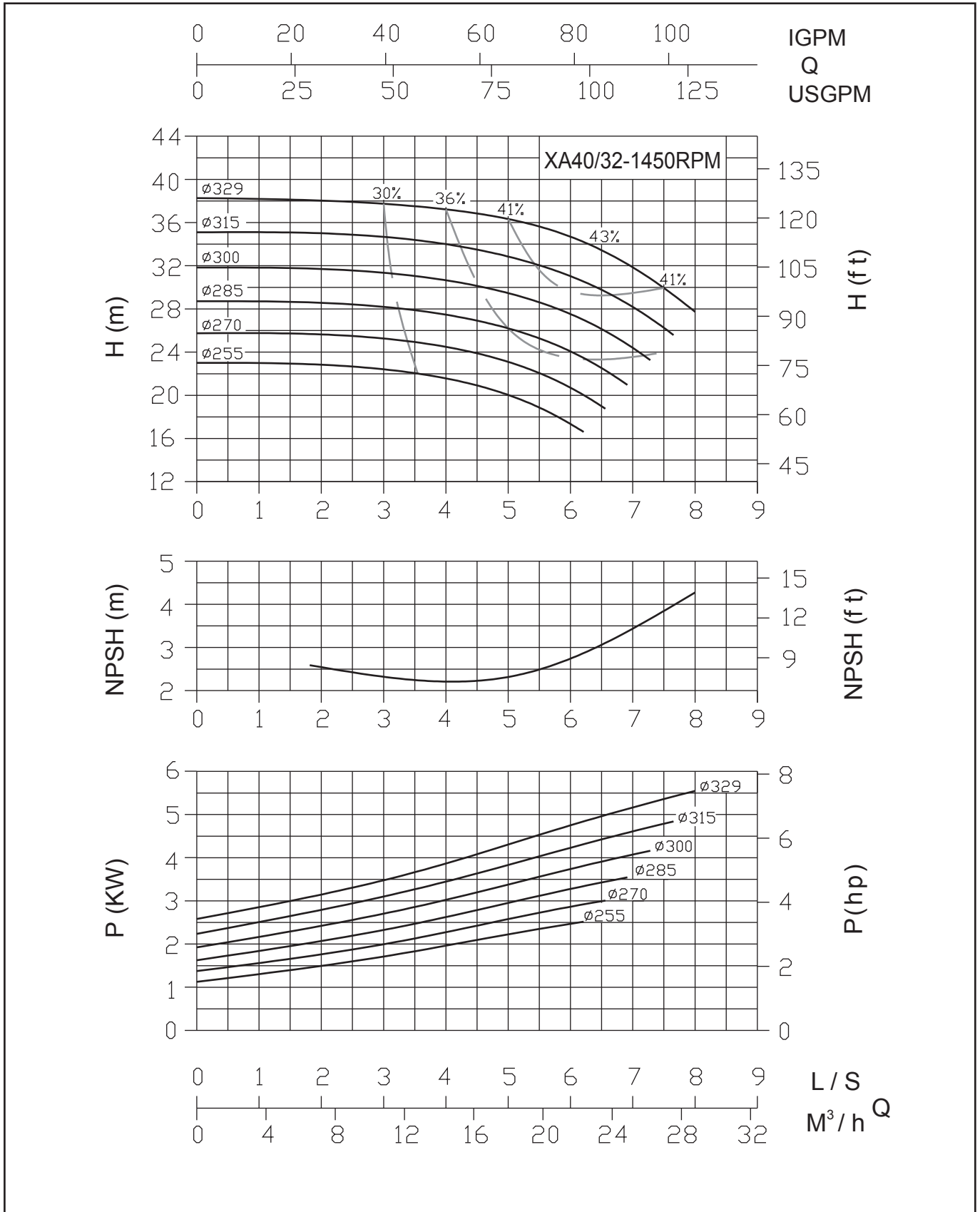

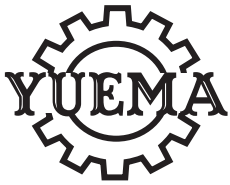

# END SUCTION PUMPS PERFORMANCE CURVES XA SERIES

## XA40/32-1750RPM (60HZ)

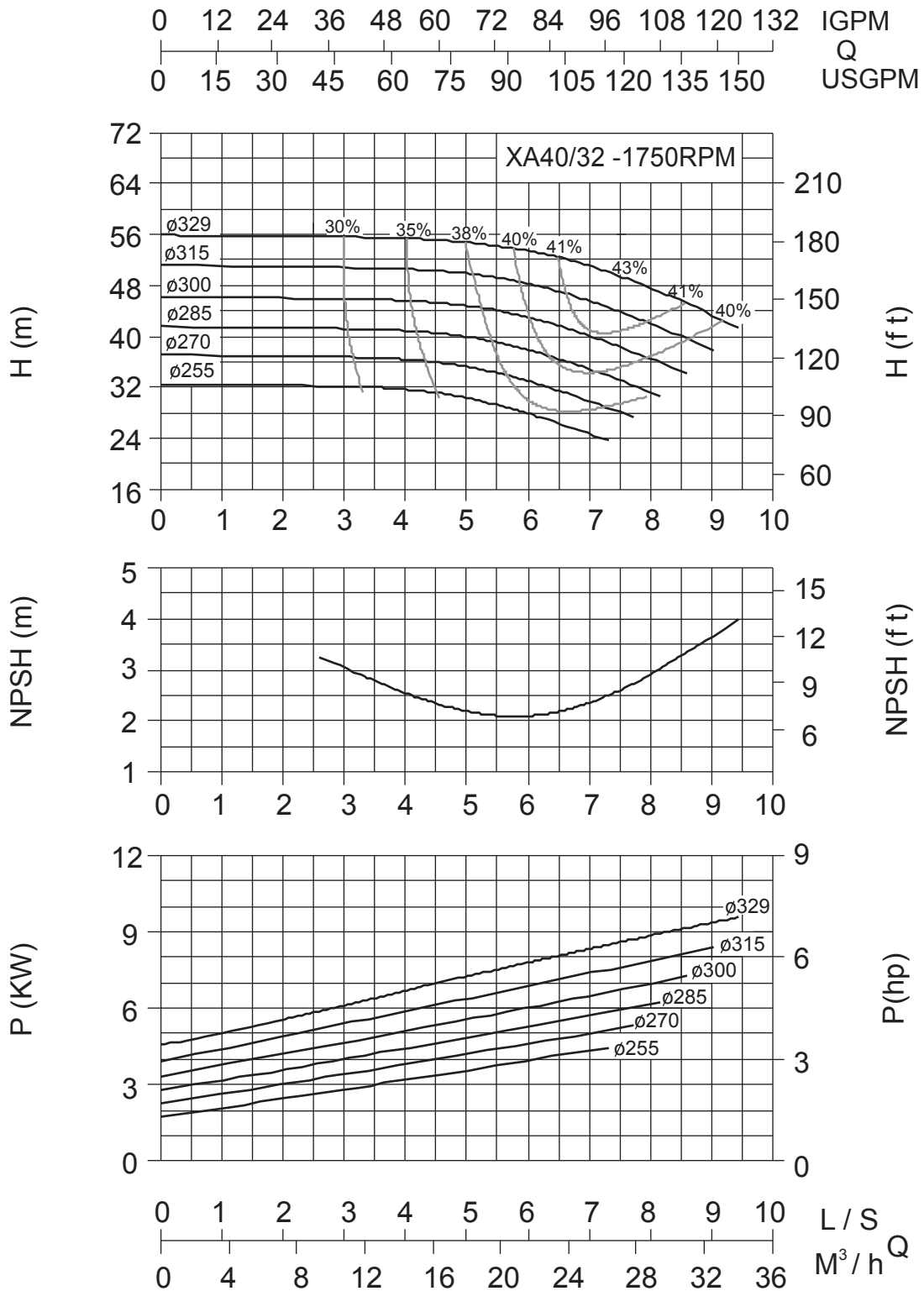

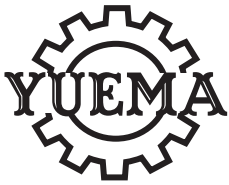

# END SUCTION PUMPS PERFORMANCE CURVES XA SERIES

## XA50/13-1450RPM (50HZ)

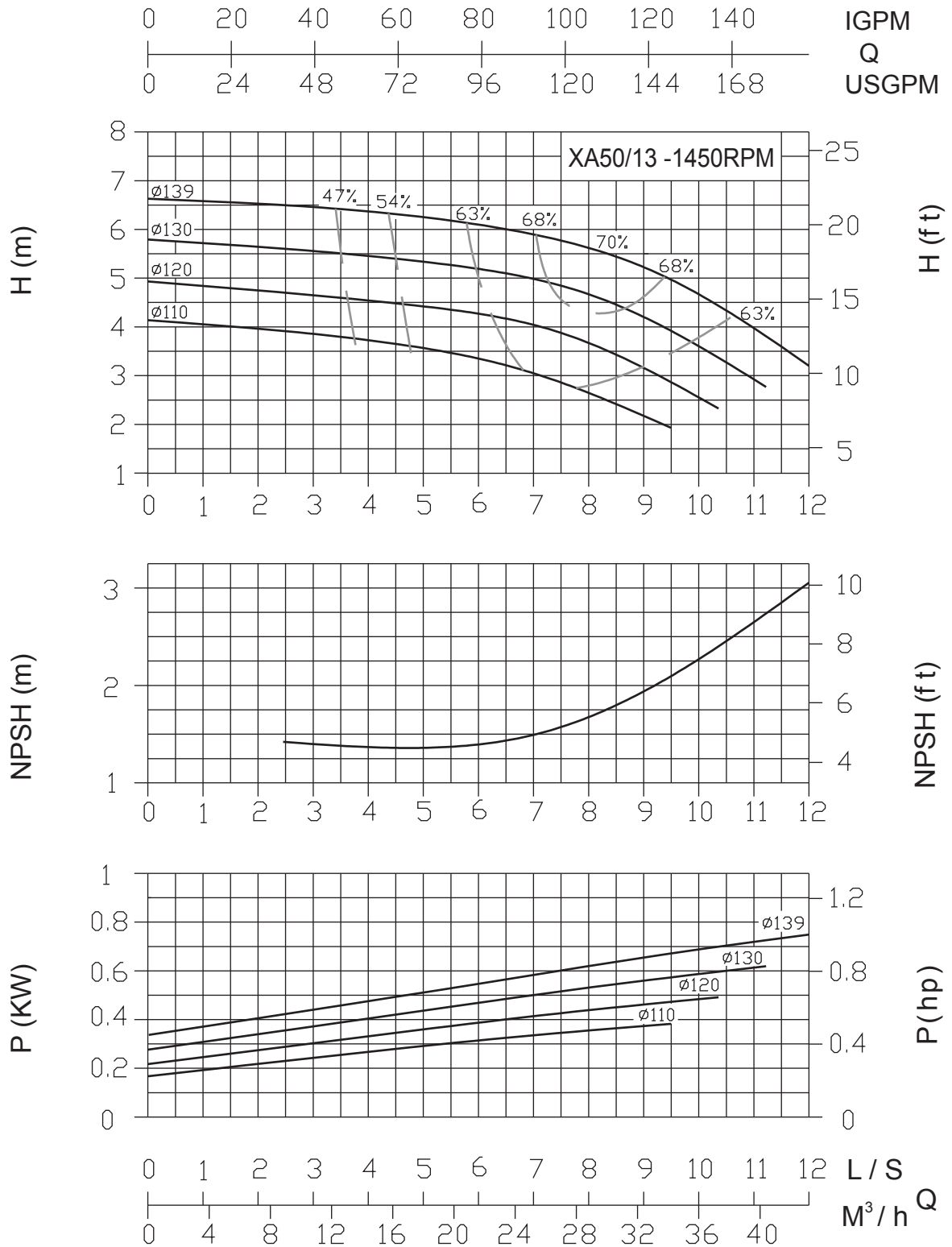



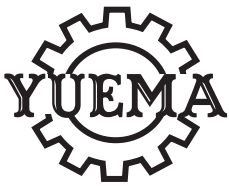

# END SUCTION PUMPS PERFORMANCE CURVES XA SERIES

## XA50/13-1750RPM (60HZ)

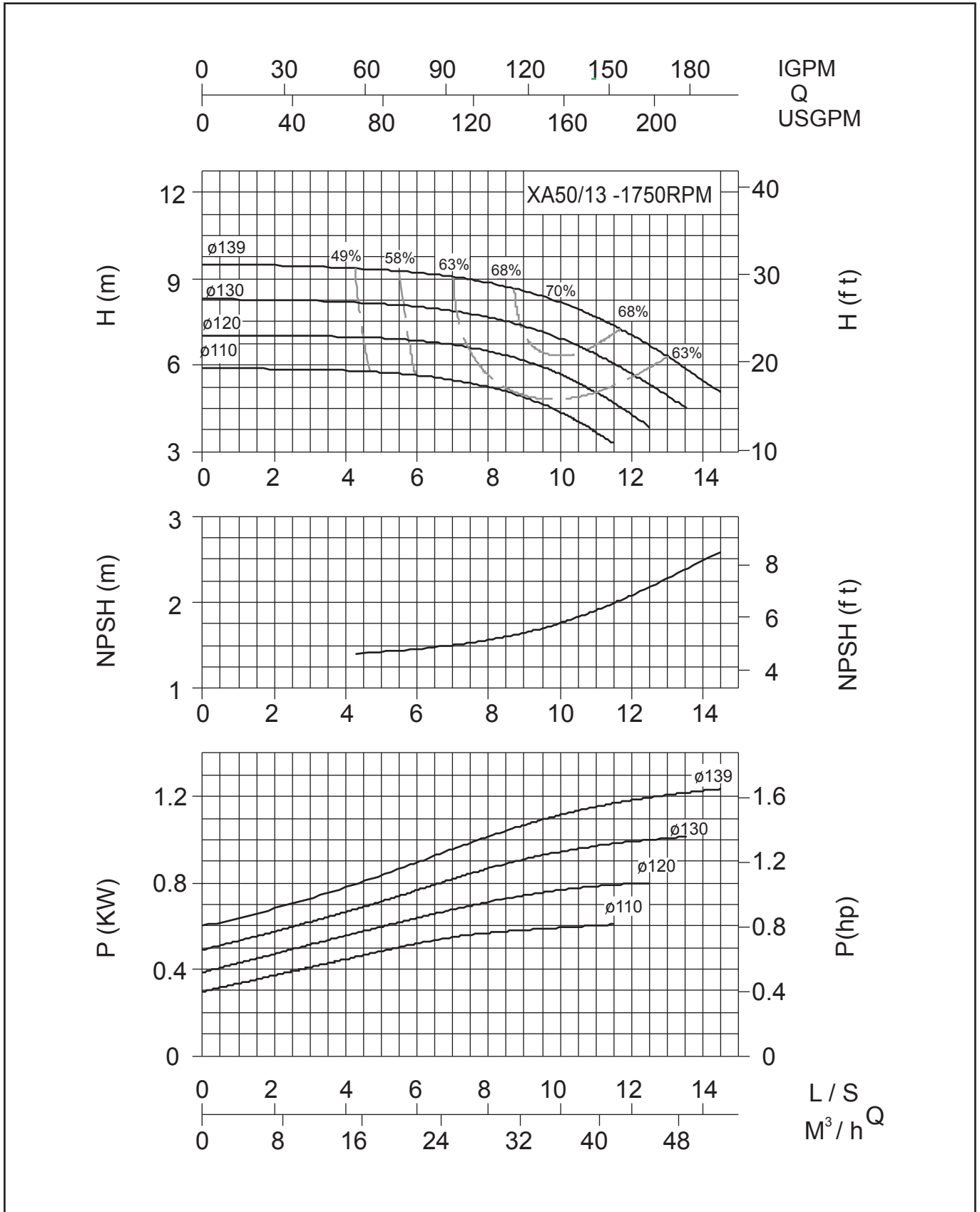

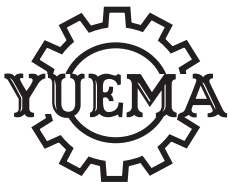

# END SUCTION PUMPS PERFORMANCE CURVES XA SERIES

## XA50/16-1450RPM (50HZ)

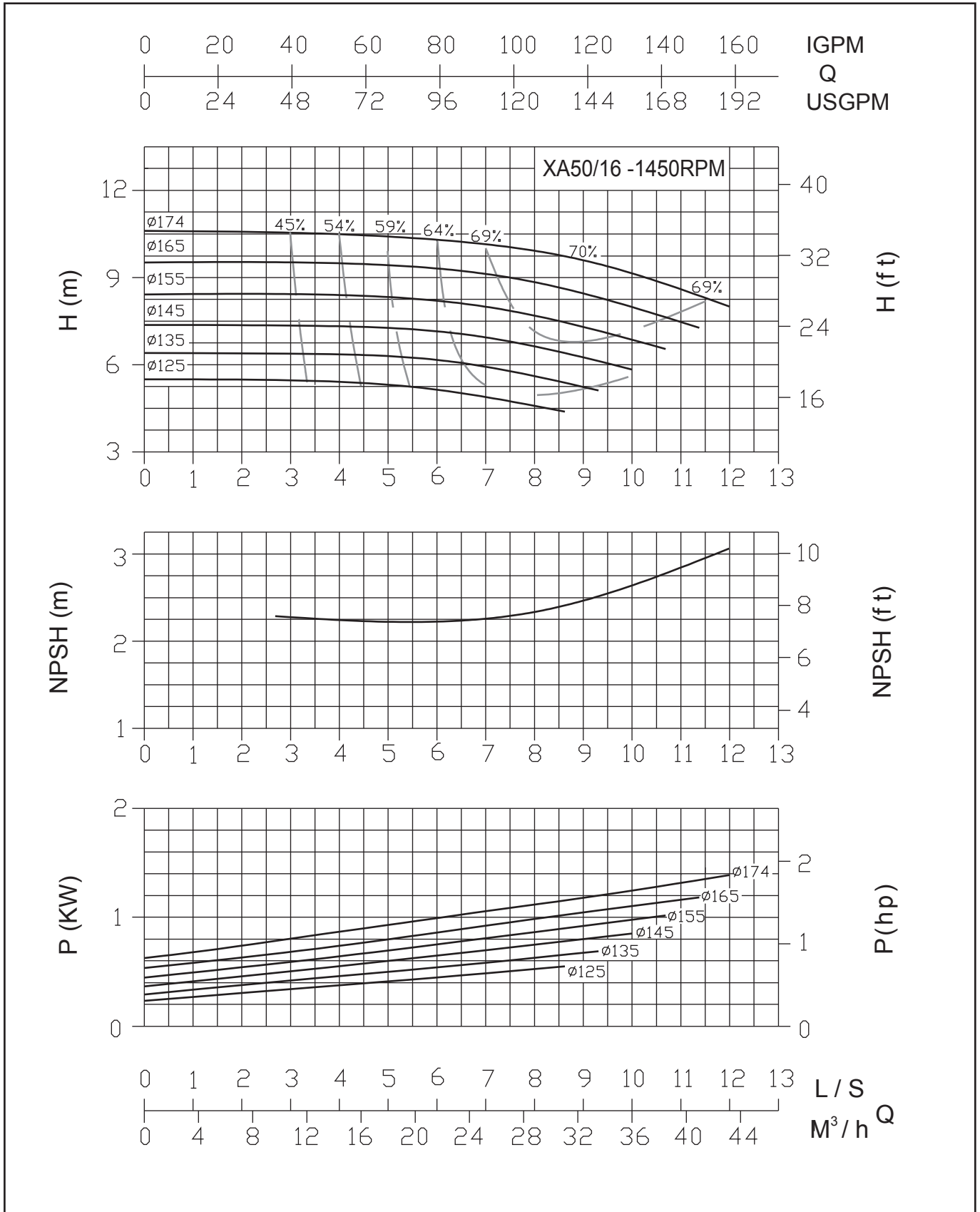

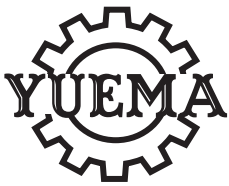

# END SUCTION PUMPS PERFORMANCE CURVES XA SERIES XA50/16-1750RPM (60HZ)

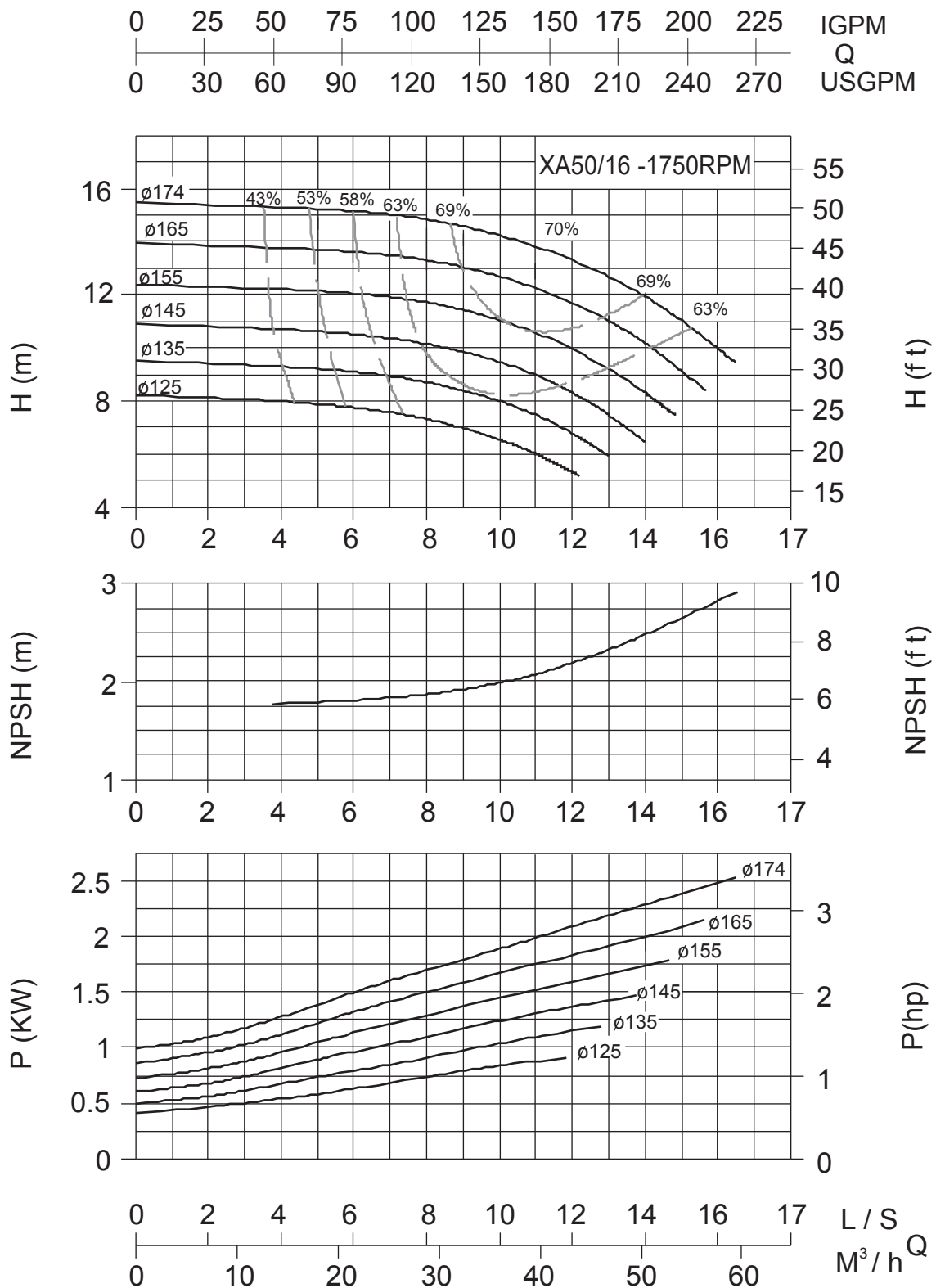

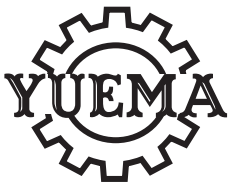

# END SUCTION PUMPS PERFORMANCE CURVES XA SERIES

## XA50/20-1450RPM (50HZ)

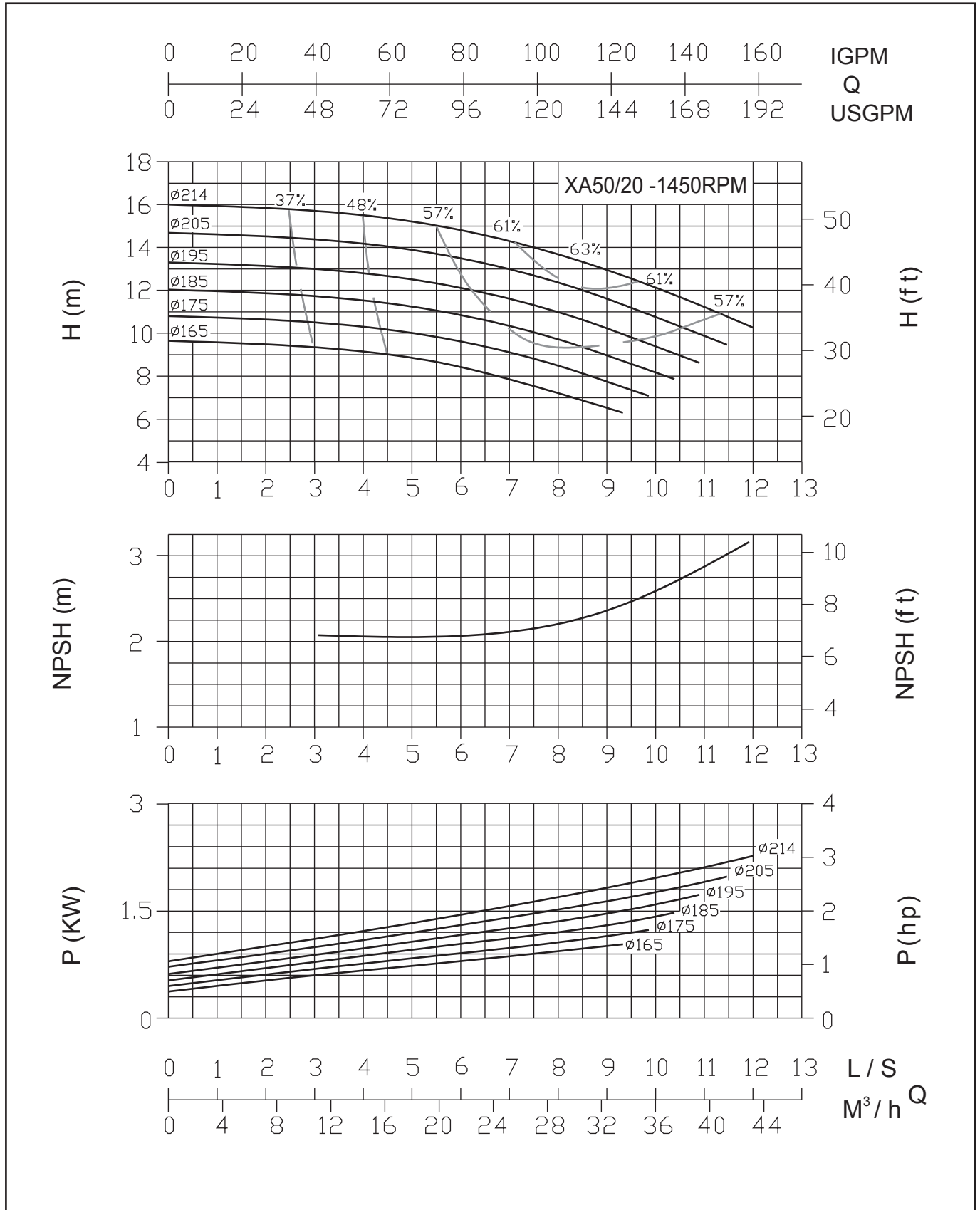



# END SUCTION PUMPS PERFORMANCE CURVES XA SERIES

## XA50/20-1750RPM (60HZ)

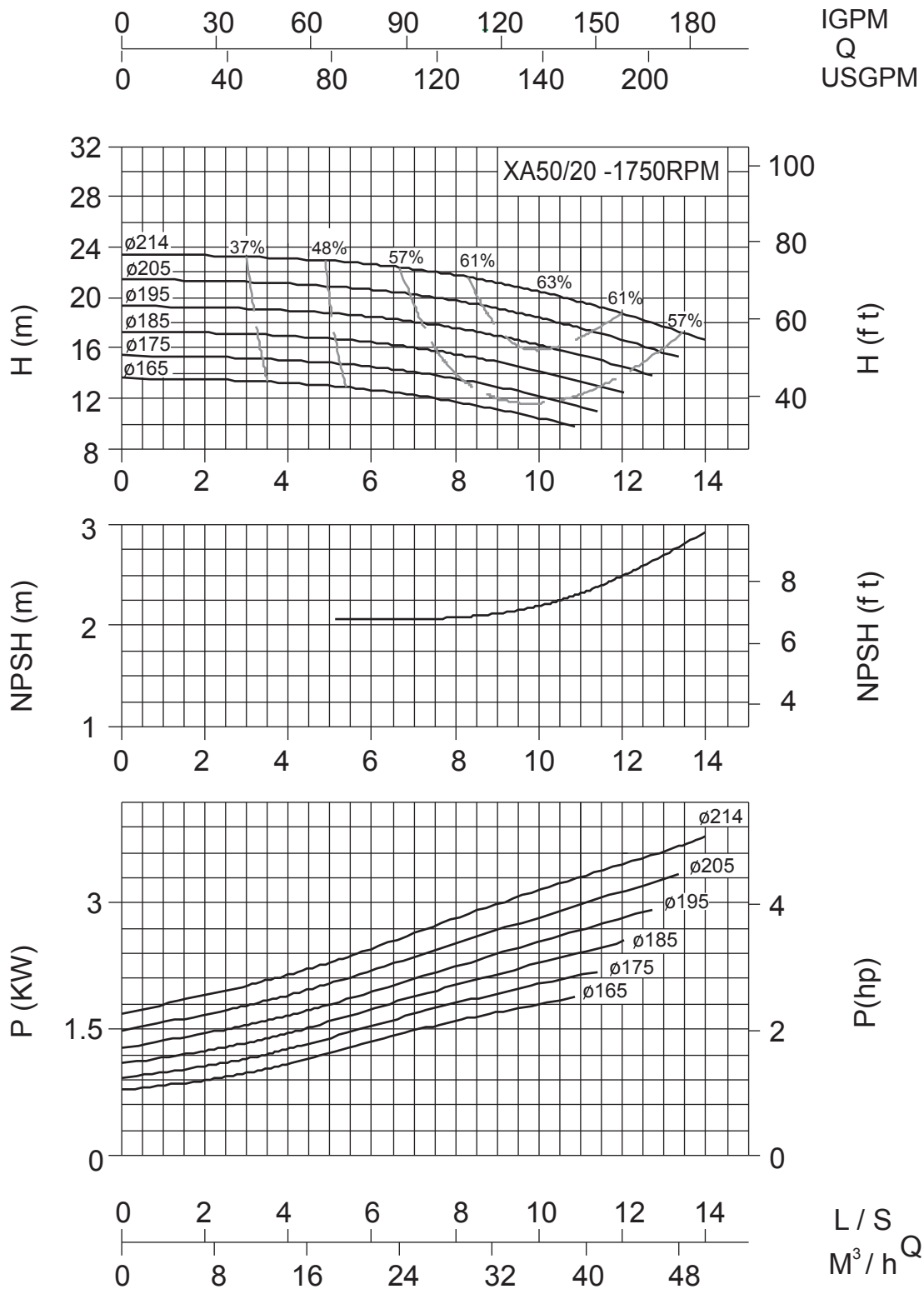



# END SUCTION PUMPS PERFORMANCE CURVES XA SERIES

## XA50/26-1450RPM (50HZ)

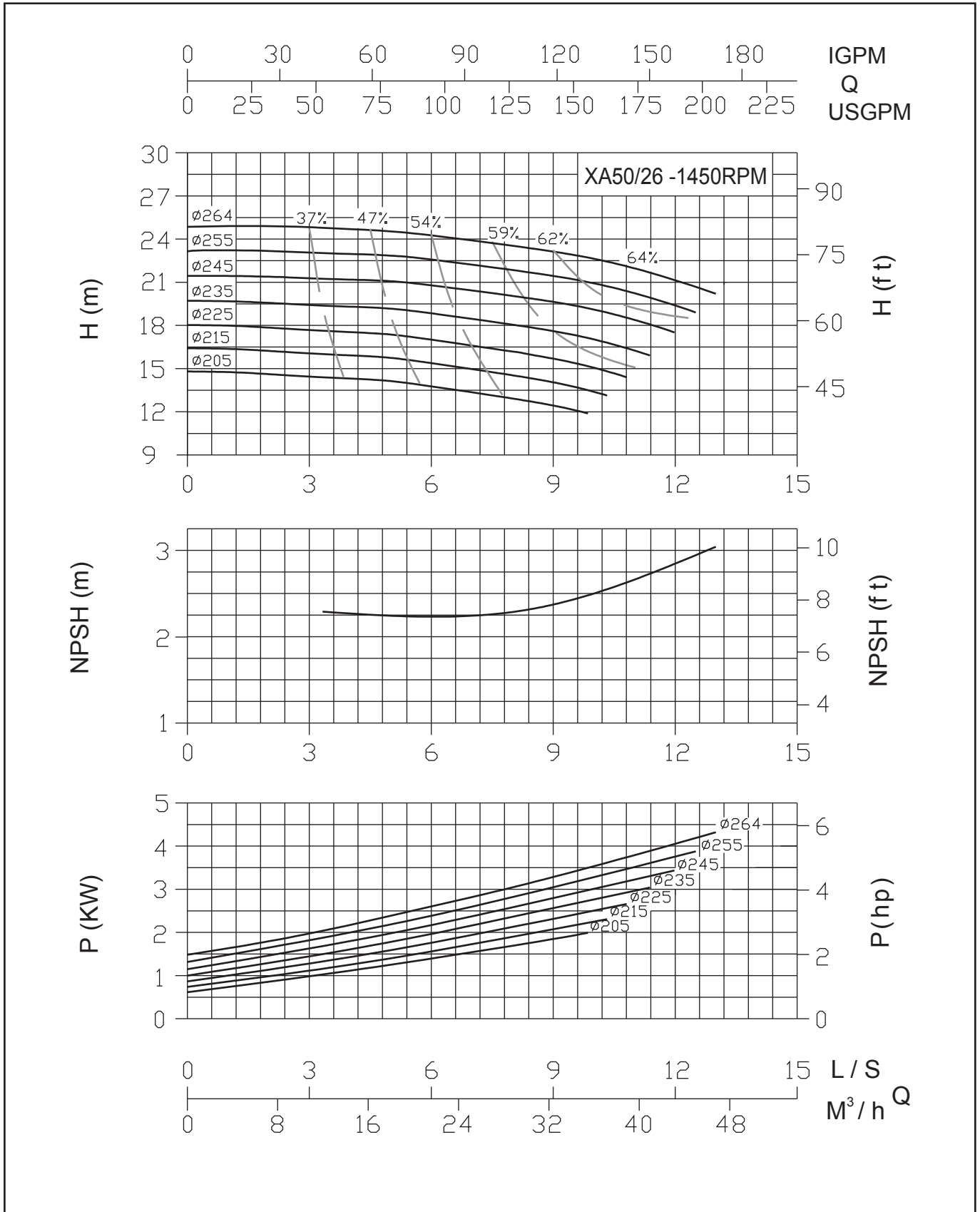

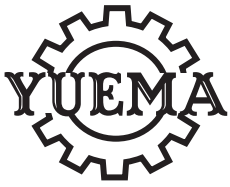

# END SUCTION PUMPS PERFORMANCE CURVES XA SERIES

## XA50/26-1750RPM (60HZ)

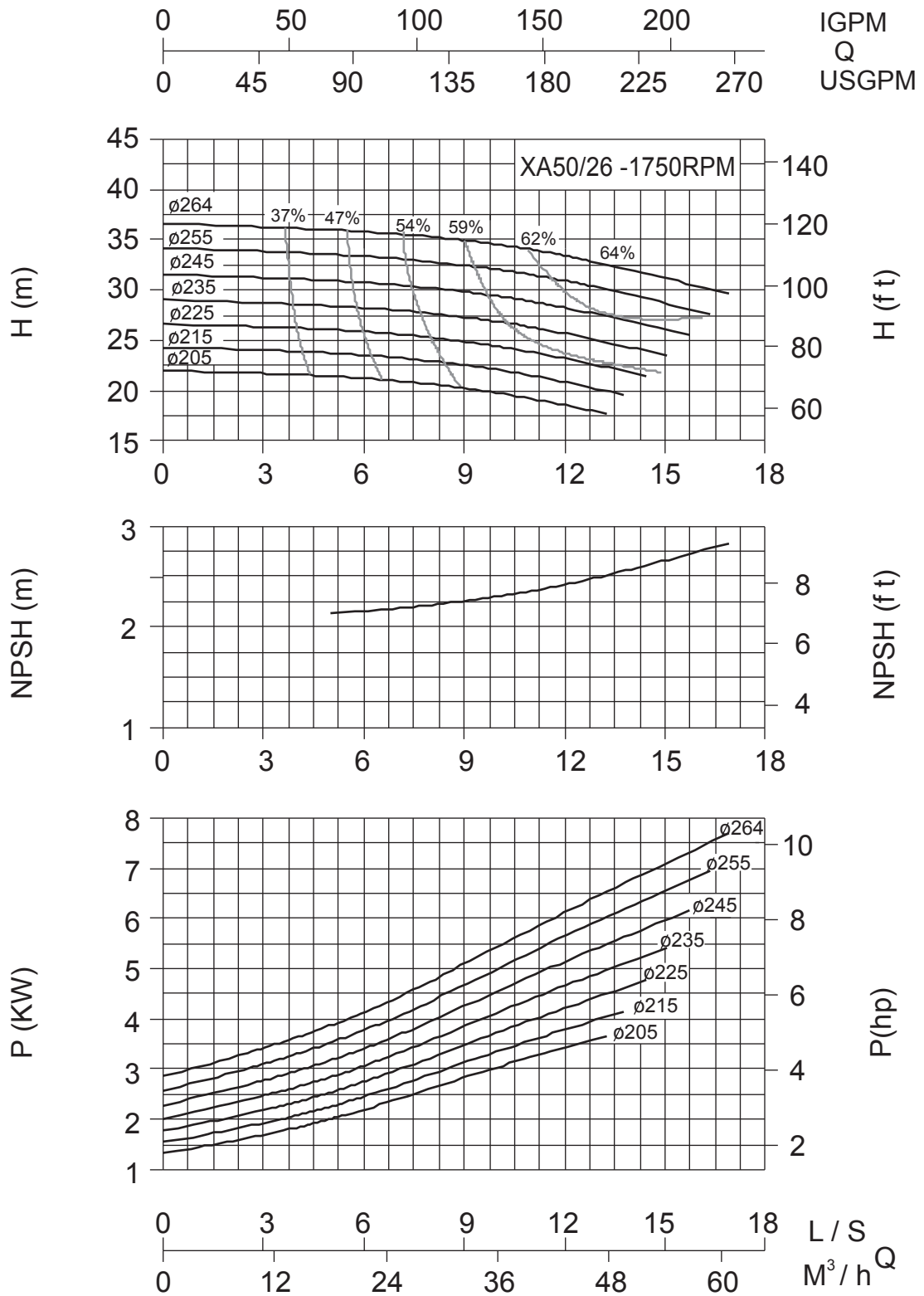



# END SUCTION PUMPS PERFORMANCE CURVES XA SERIES

## XA50/32-1450RPM (50HZ)

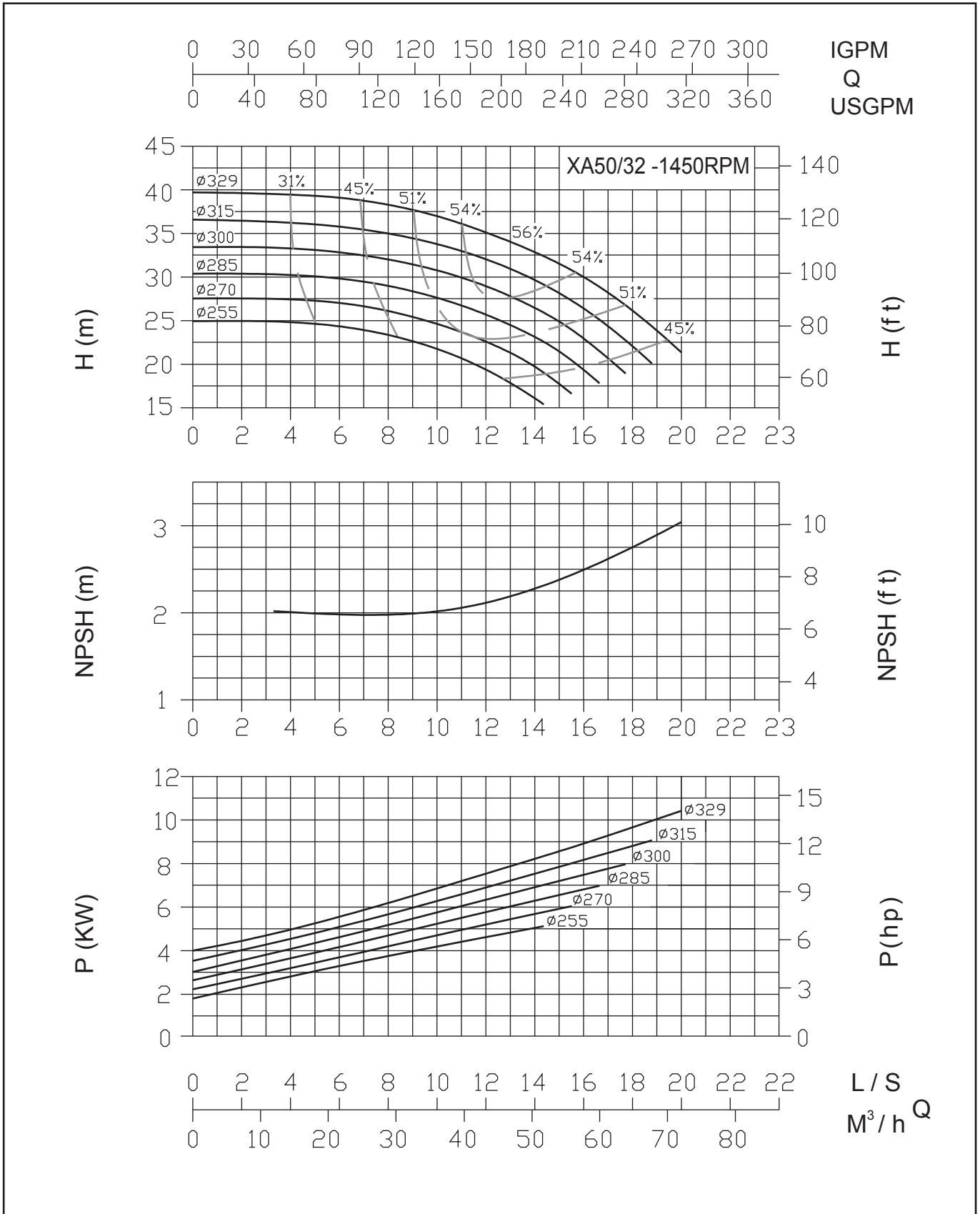



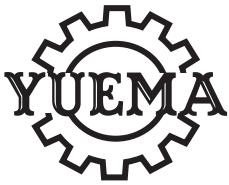

# END SUCTION PUMPS PERFORMANCE CURVES XA SERIES

## XA50/32-1750RPM (60HZ)

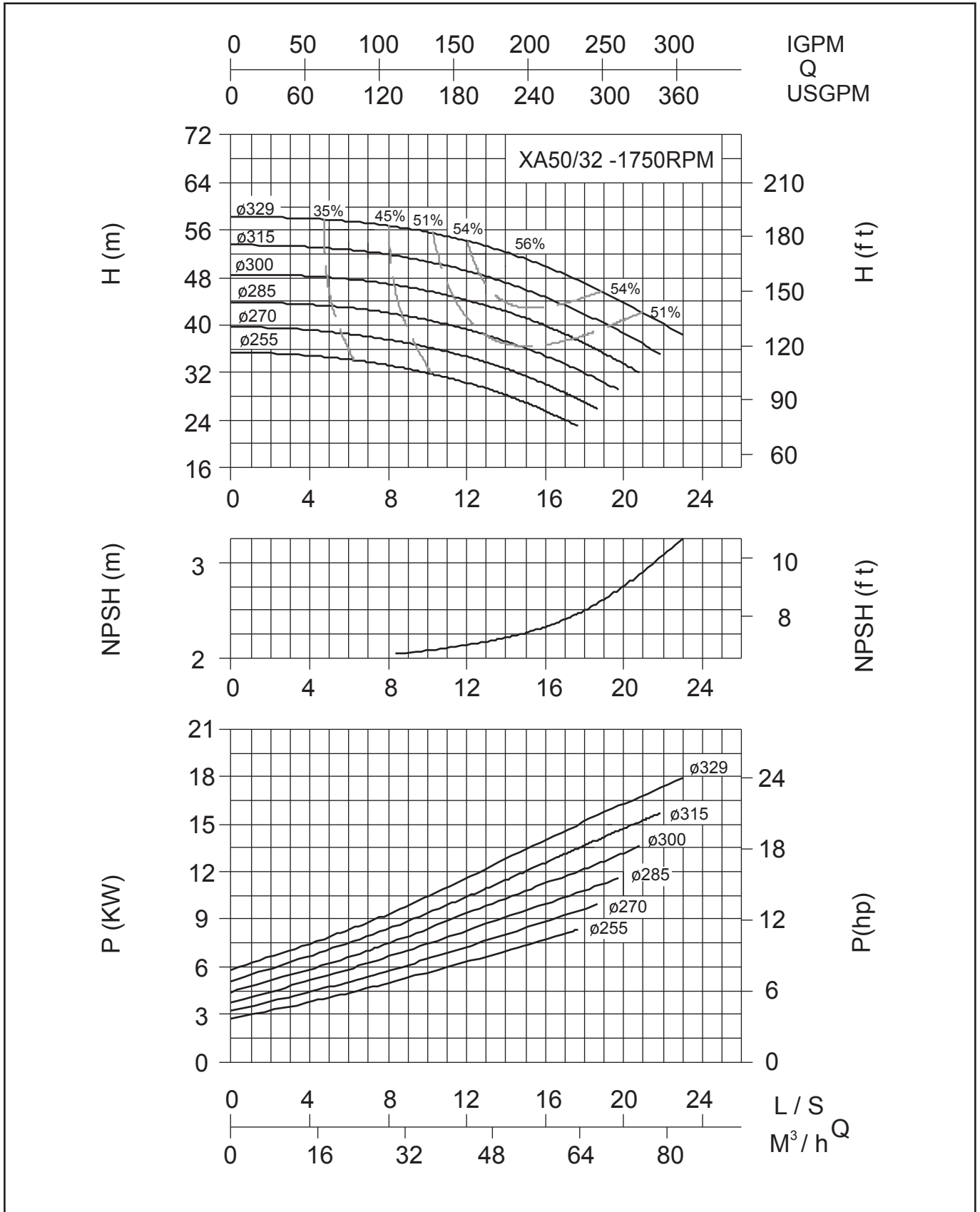



# END SUCTION PUMPS PERFORMANCE CURVES XA SERIES

## XA65/13-1450RPM (50HZ)

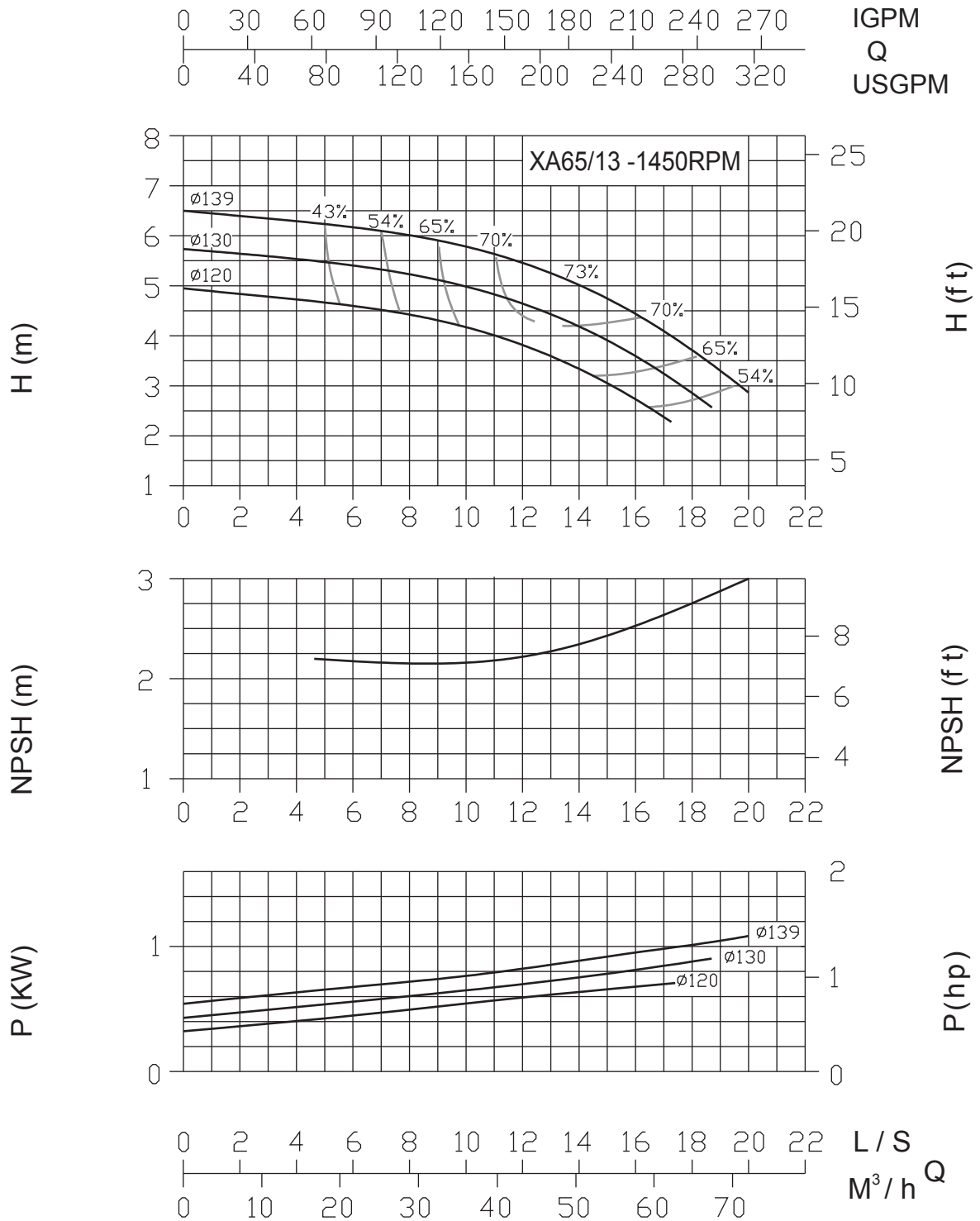

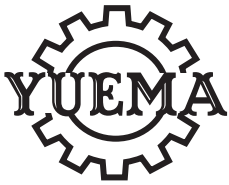

# END SUCTION PUMPS PERFORMANCE CURVES XA SERIES

## XA65/13-1750RPM (60HZ)

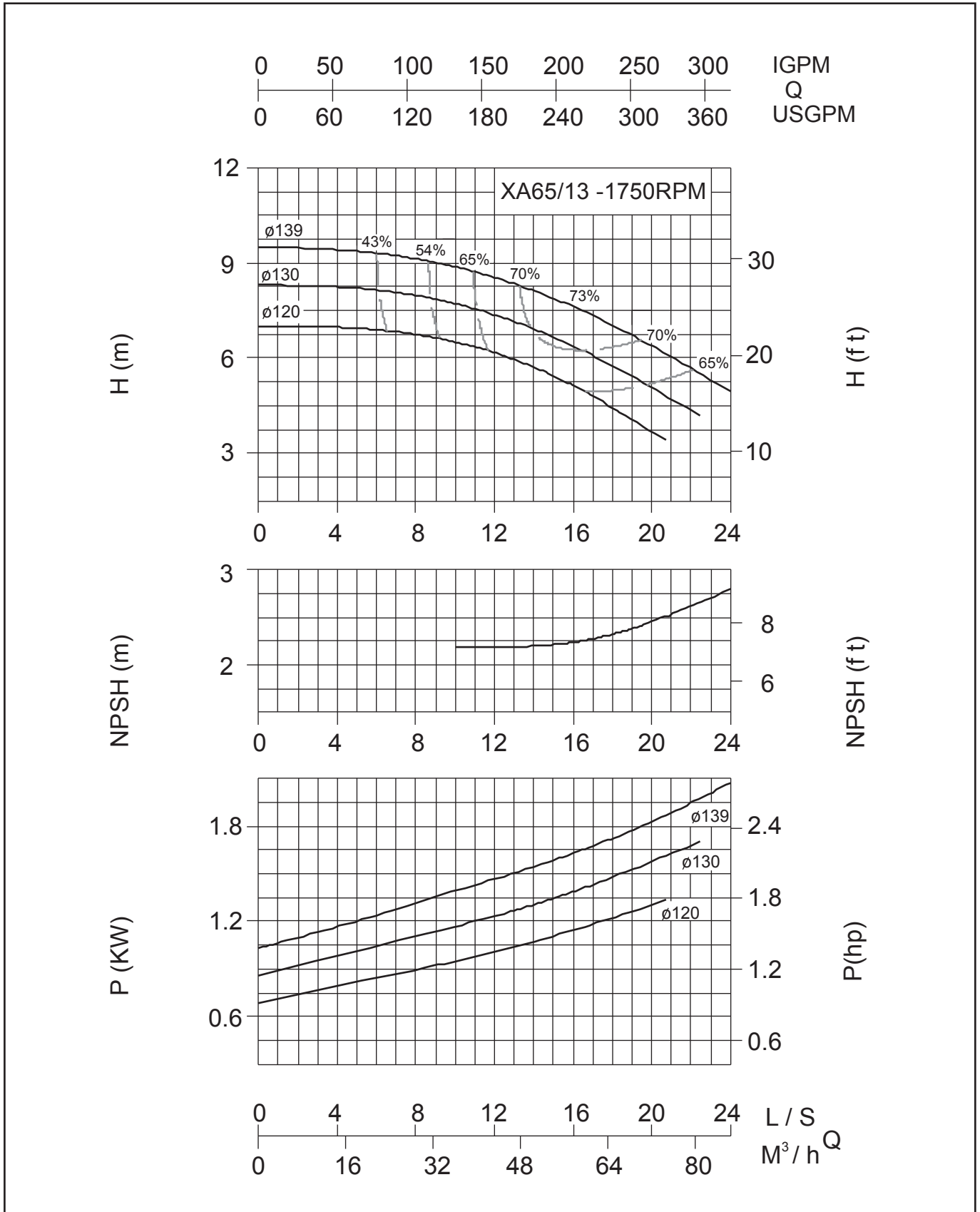

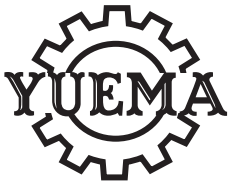

# END SUCTION PUMPS PERFORMANCE CURVES XA SERIES

## XA65/16-1450RPM (50HZ)

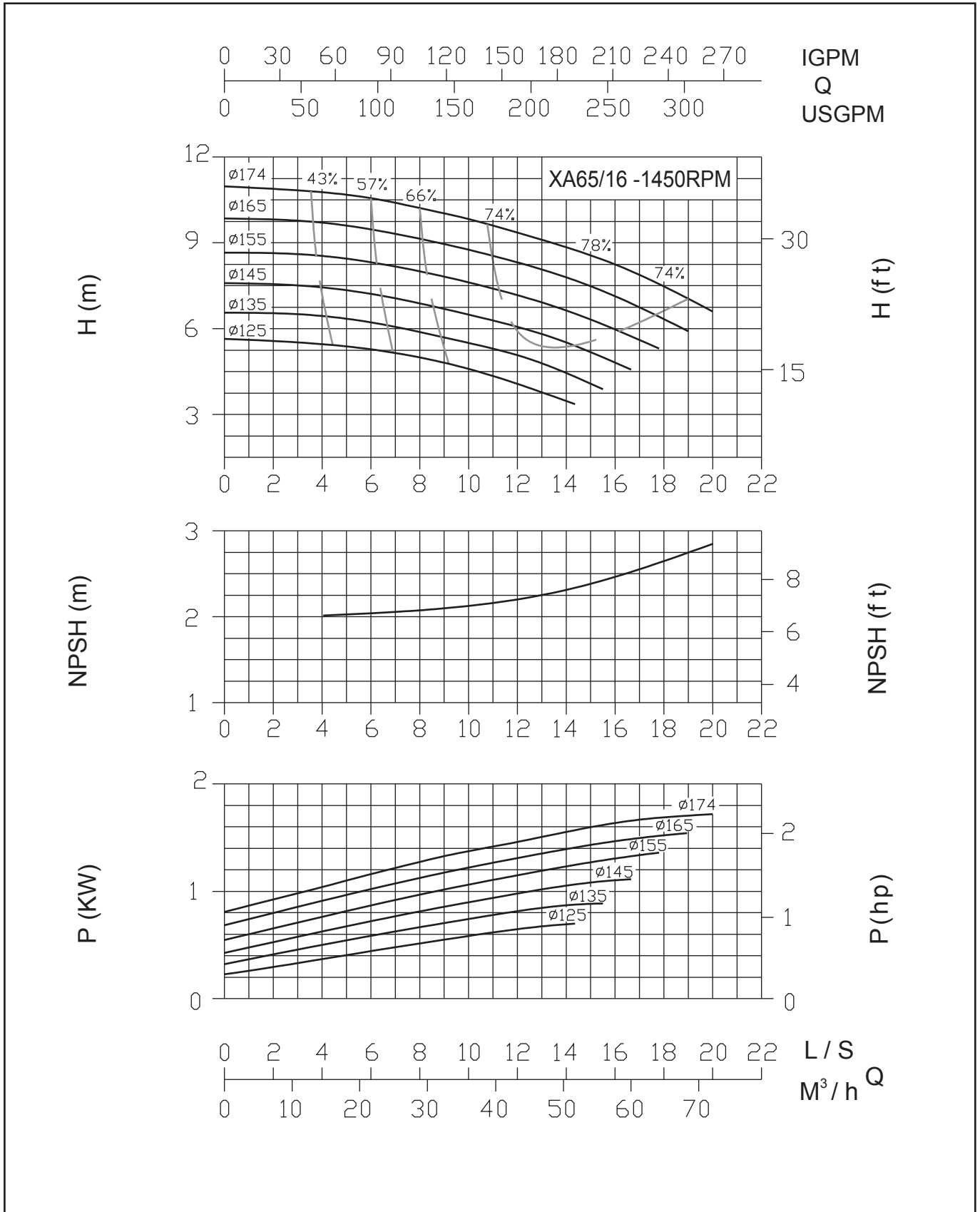



# END SUCTION PUMPS PERFORMANCE CURVES XA SERIES

## XA65/16-1750RPM (60HZ)

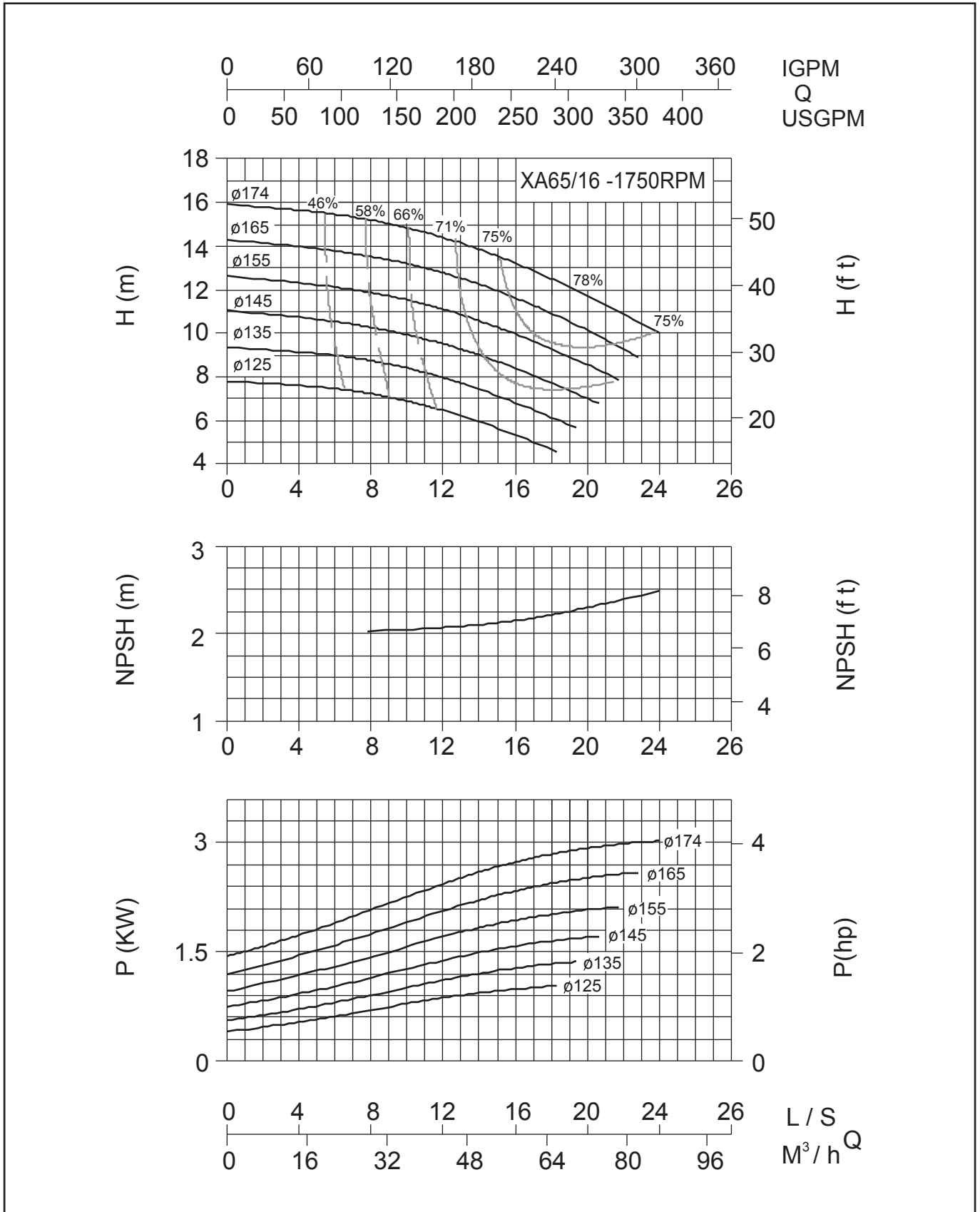

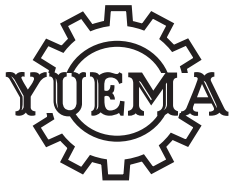

# END SUCTION PUMPS PERFORMANCE CURVES XA SERIES

## XA65/20-1450RPM (50HZ)

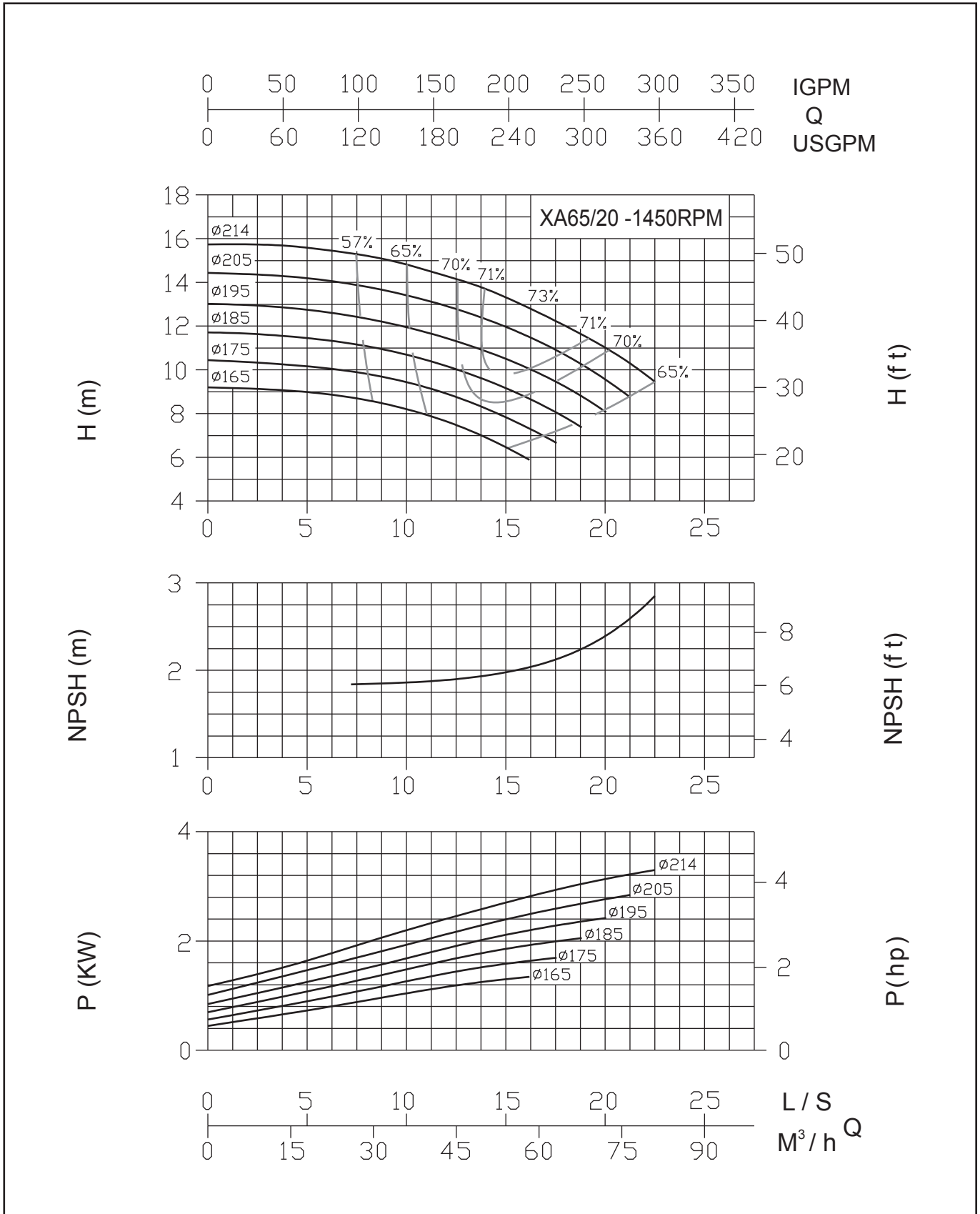



# END SUCTION PUMPS PERFORMANCE CURVES XA SERIES

## XA65/20-1750RPM (60HZ)

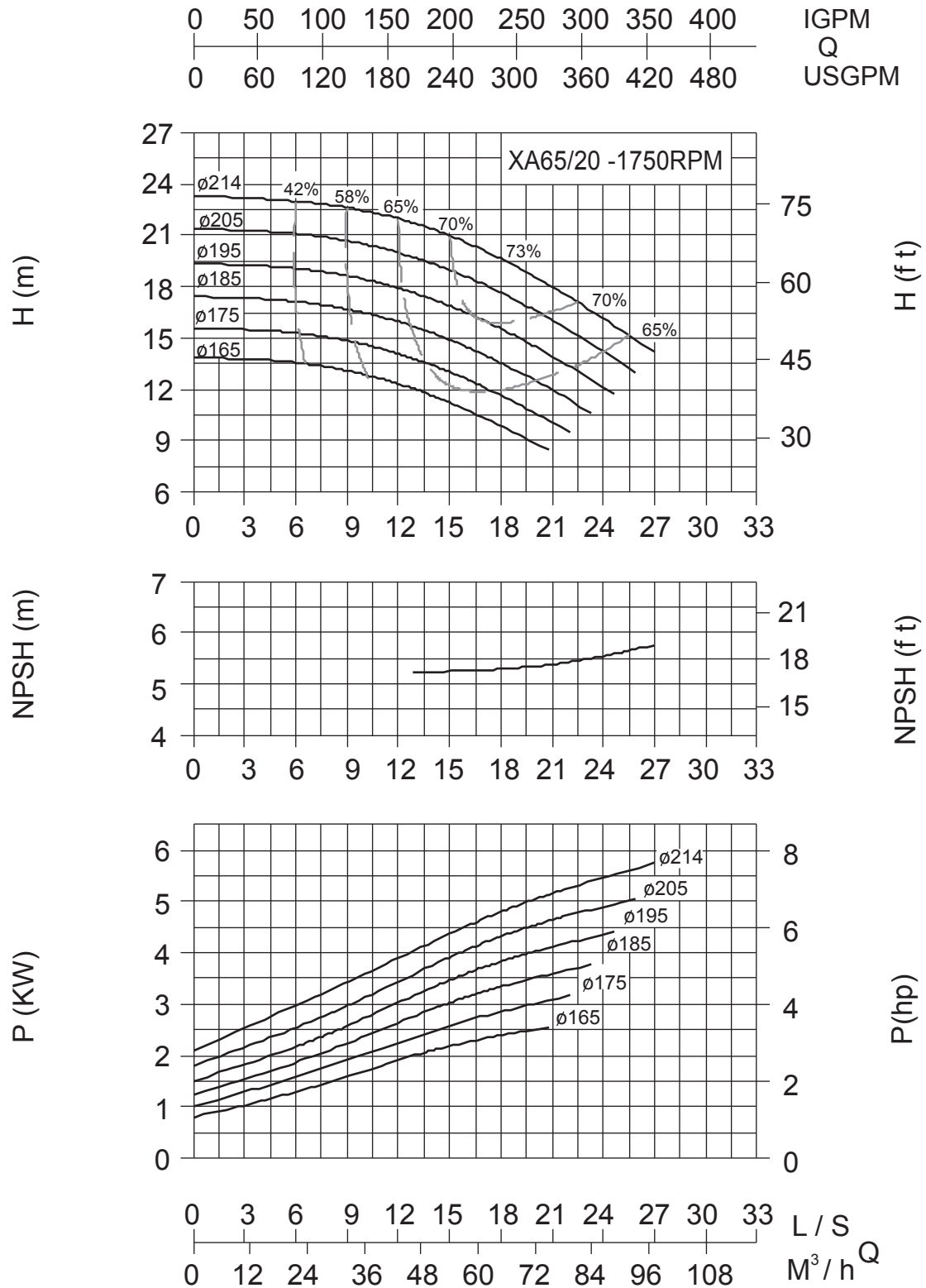



# END SUCTION PUMPS PERFORMANCE CURVES XA SERIES

## XA65/26-1450RPM (50HZ)

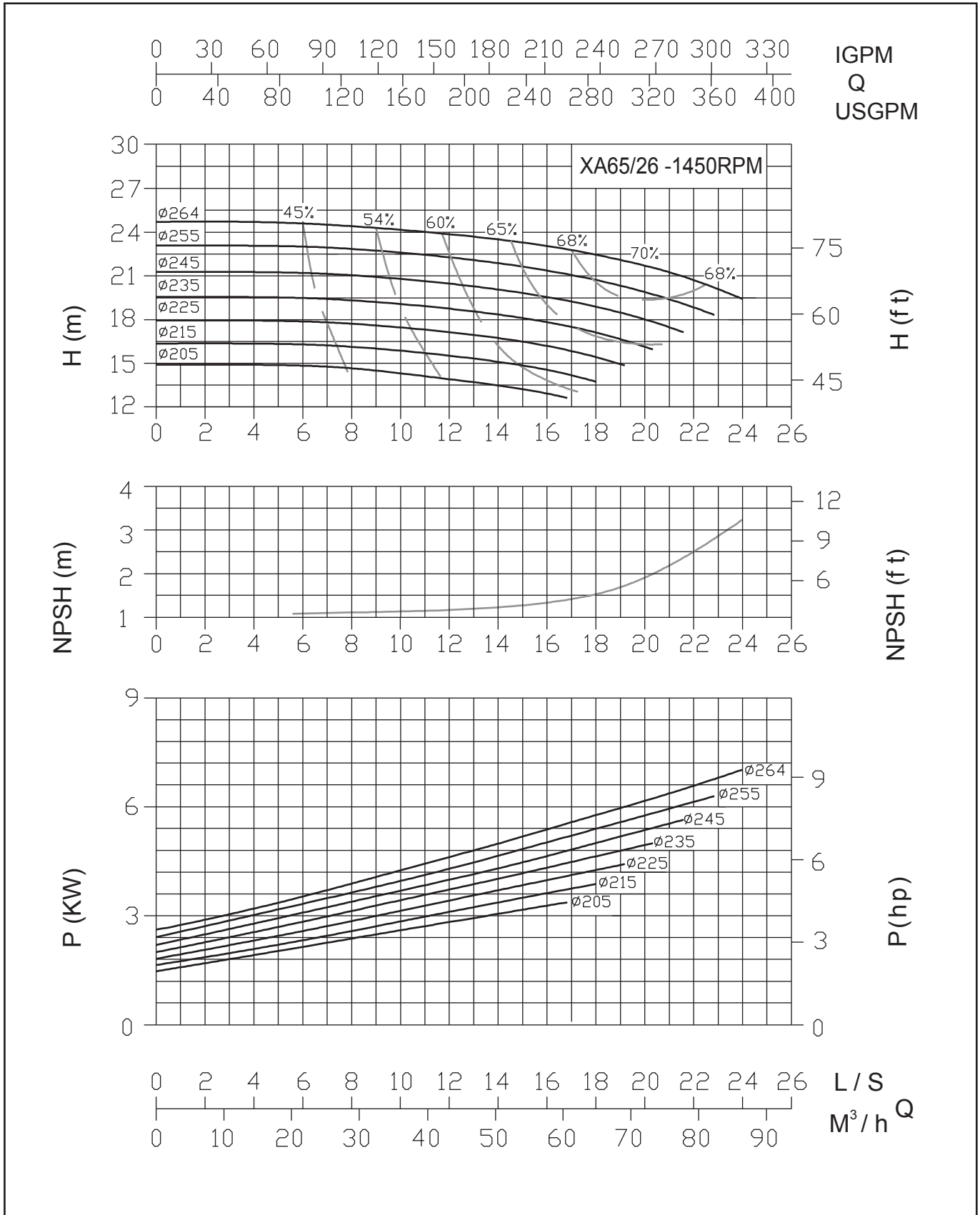



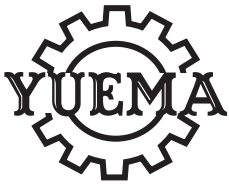

# END SUCTION PUMPS PERFORMANCE CURVES XA SERIES

## XA65/26-1750RPM (60HZ)

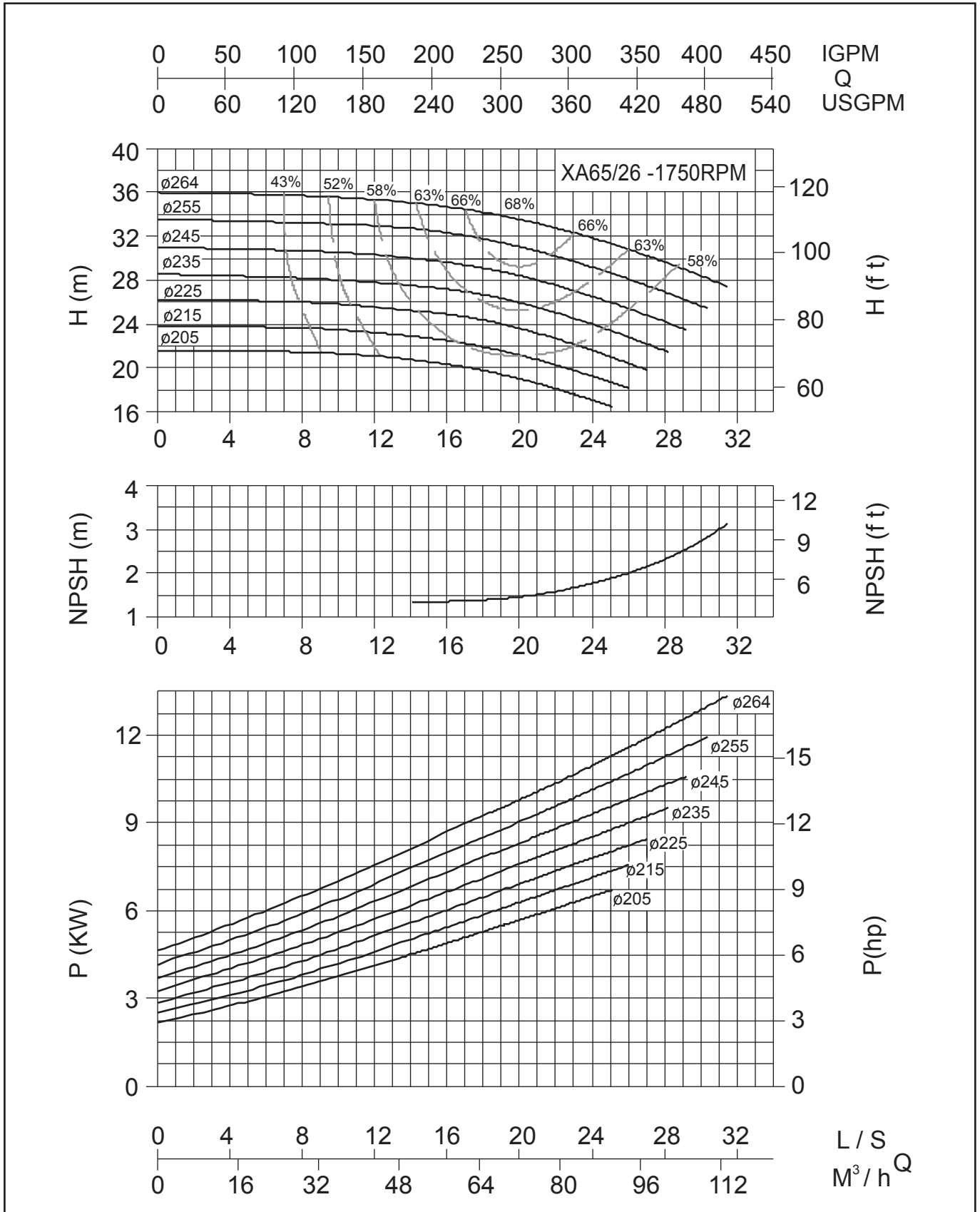



# END SUCTION PUMPS PERFORMANCE CURVES XA SERIES

## XA65/32-1450RPM (50HZ)

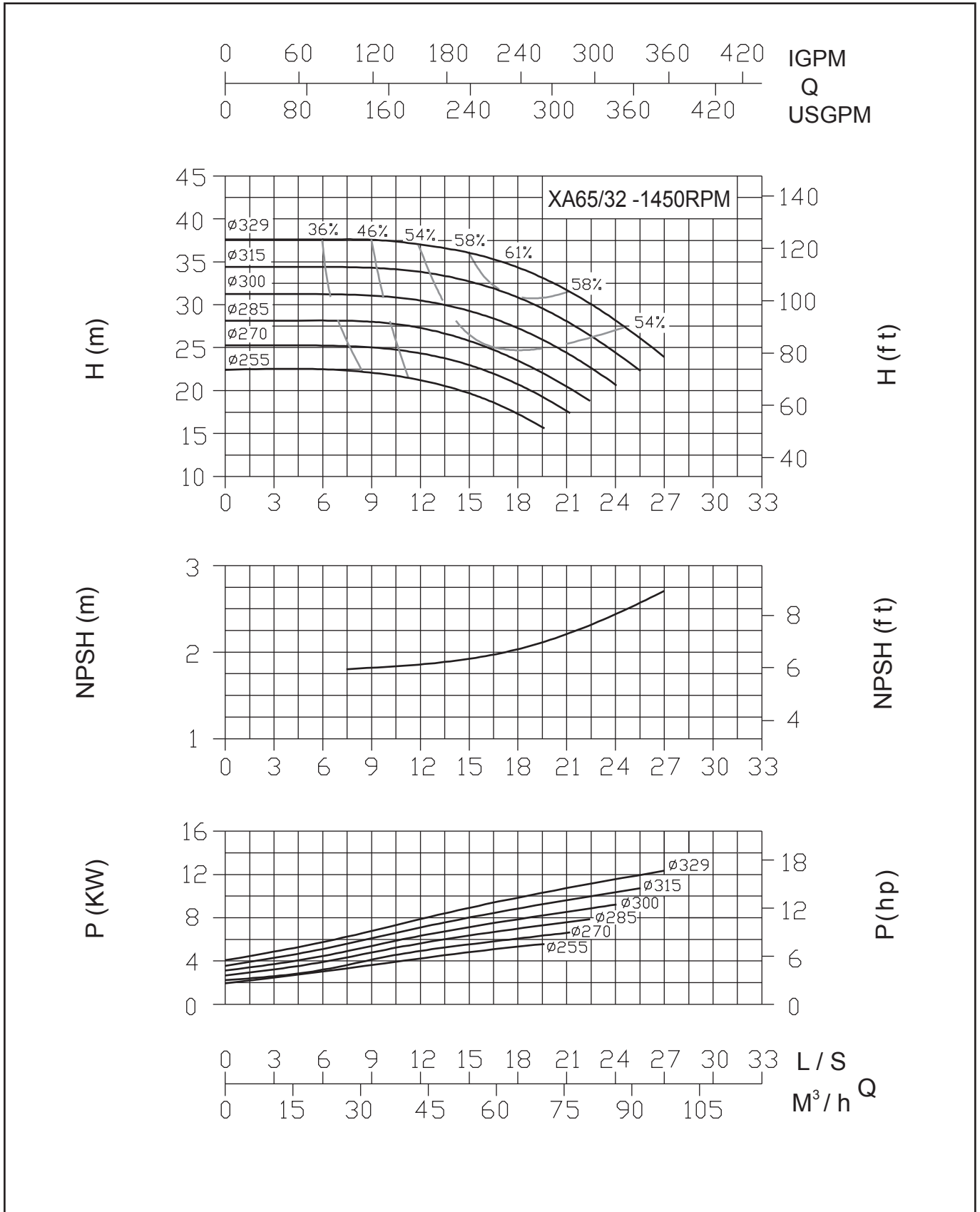



# END SUCTION PUMPS PERFORMANCE CURVES XA SERIES

## XA65/32-1750RPM (60HZ)

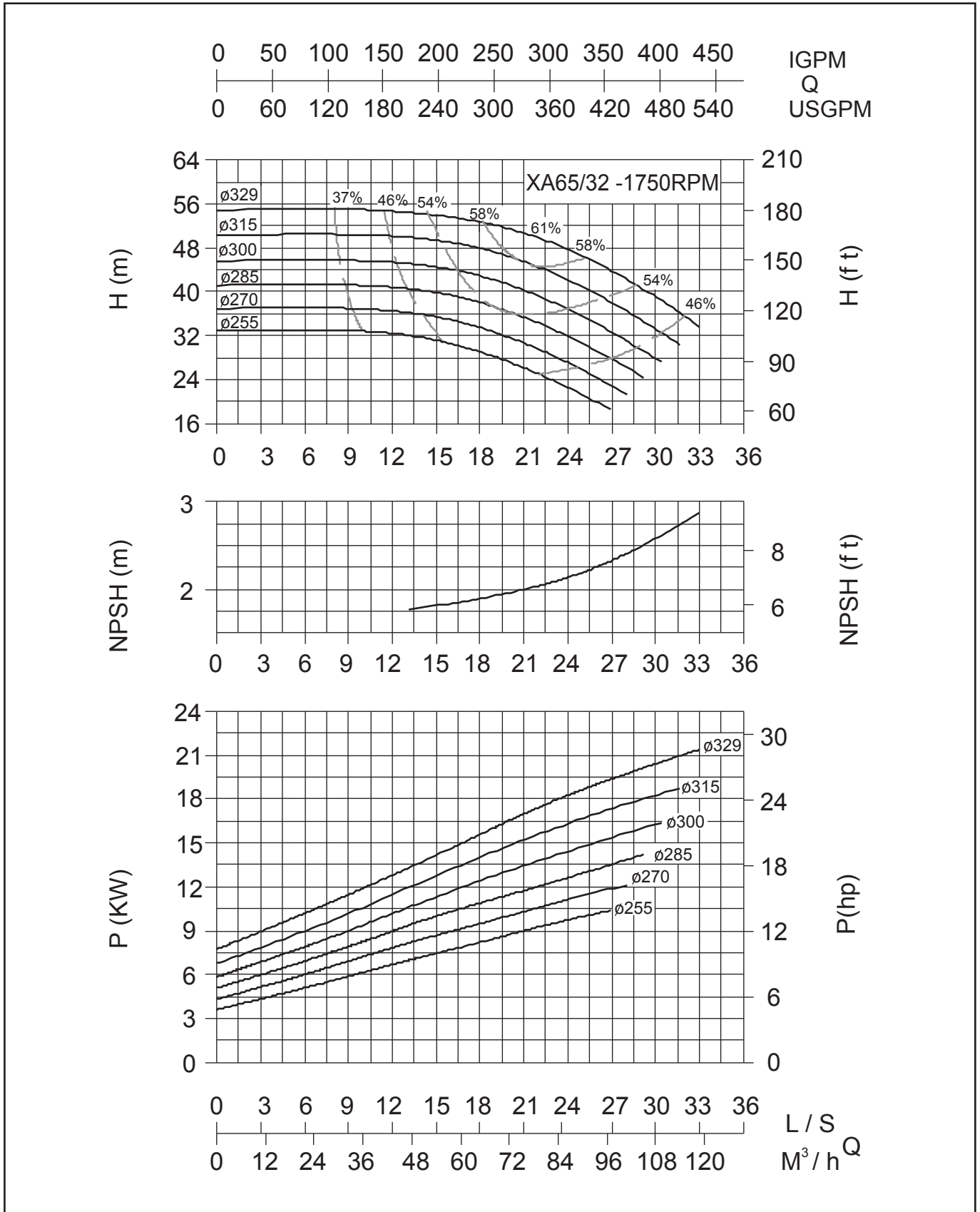

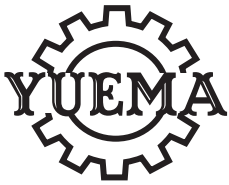

# END SUCTION PUMPS PERFORMANCE CURVES XA SERIES

## XA80/16-1450RPM (50HZ)

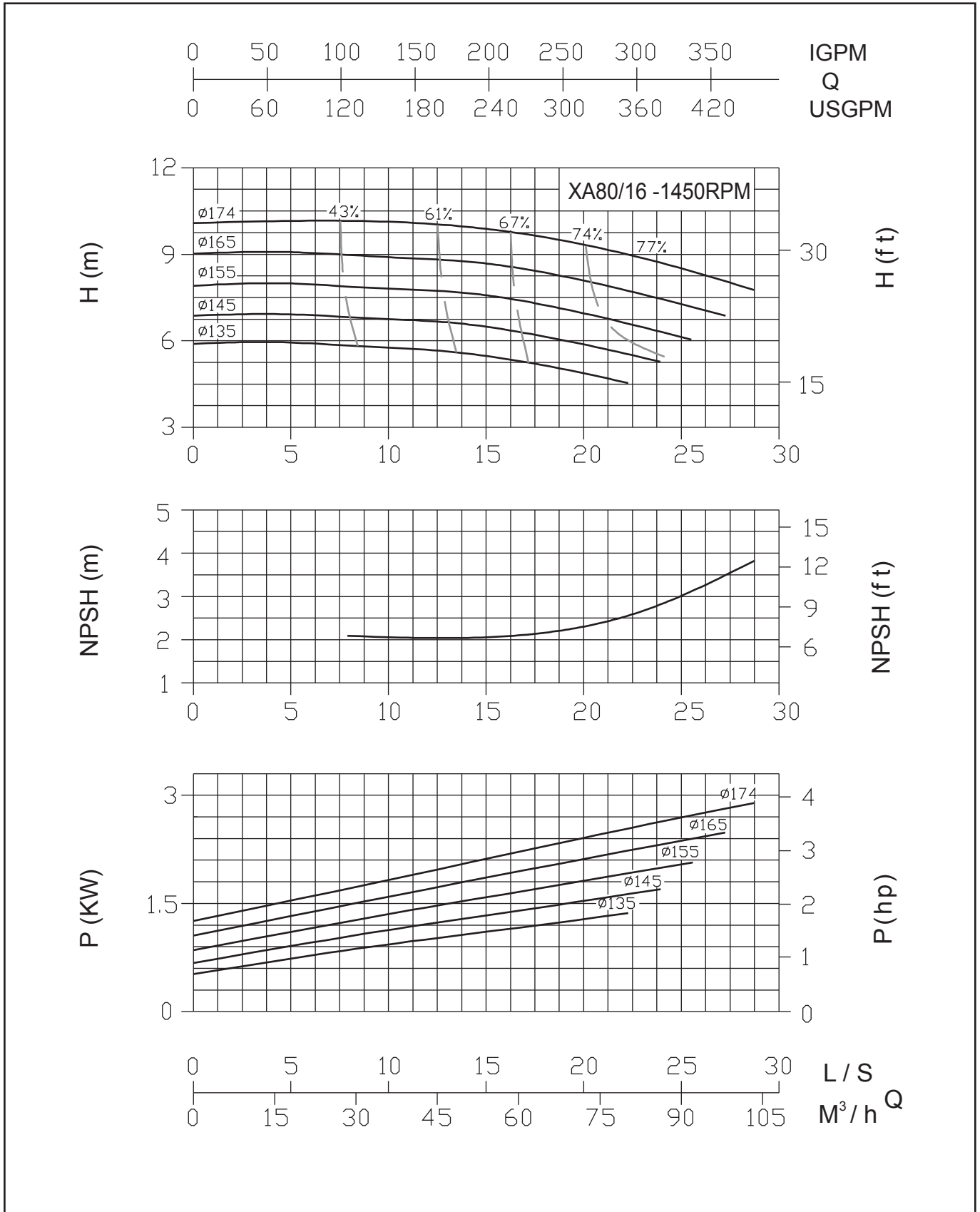



# END SUCTION PUMPS PERFORMANCE CURVES XA SERIES

## XA80/16-1750RPM (60HZ)

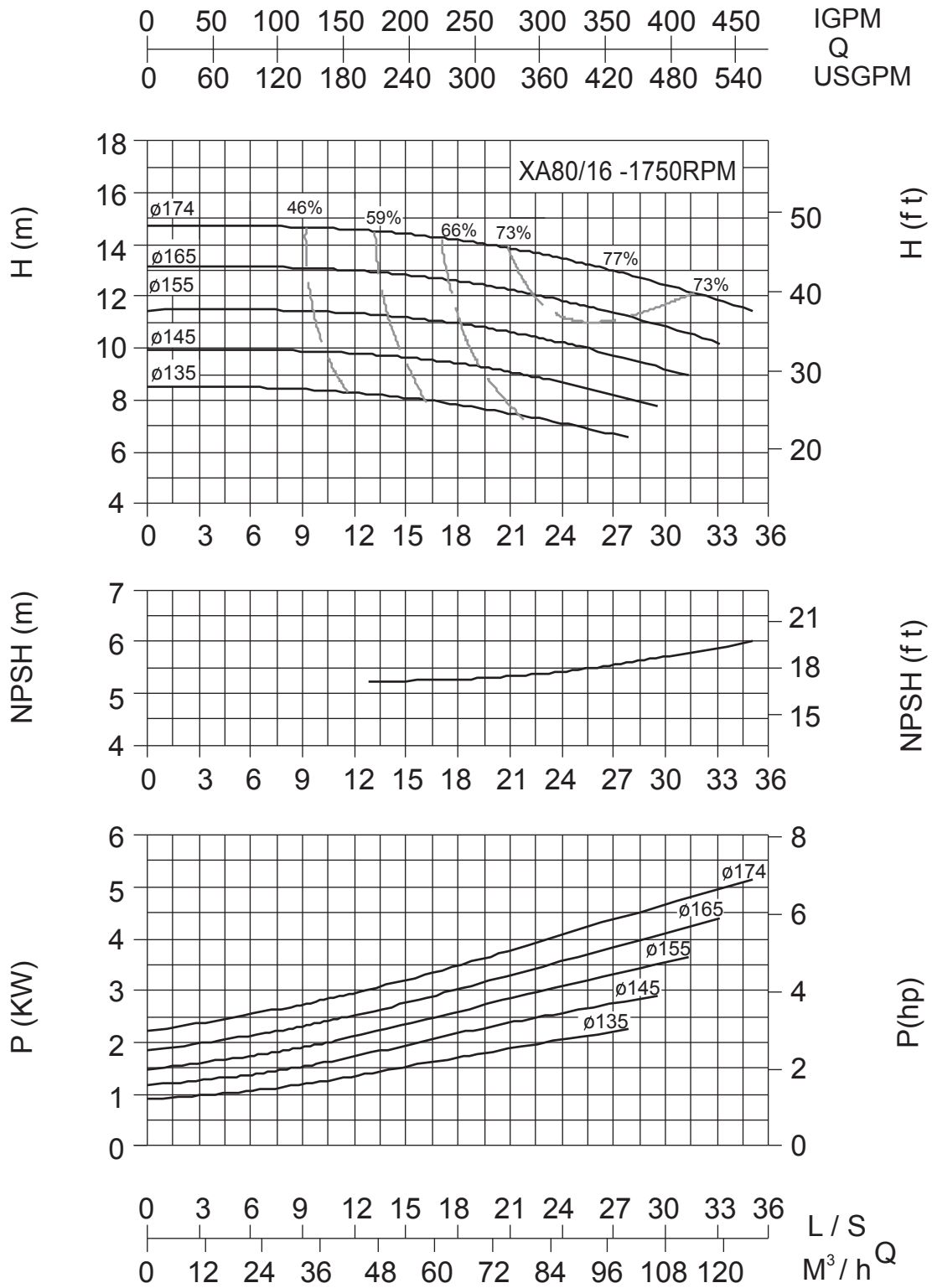



# END SUCTION PUMPS PERFORMANCE CURVES XA SERIES

## XA80/20-1450RPM (50HZ)

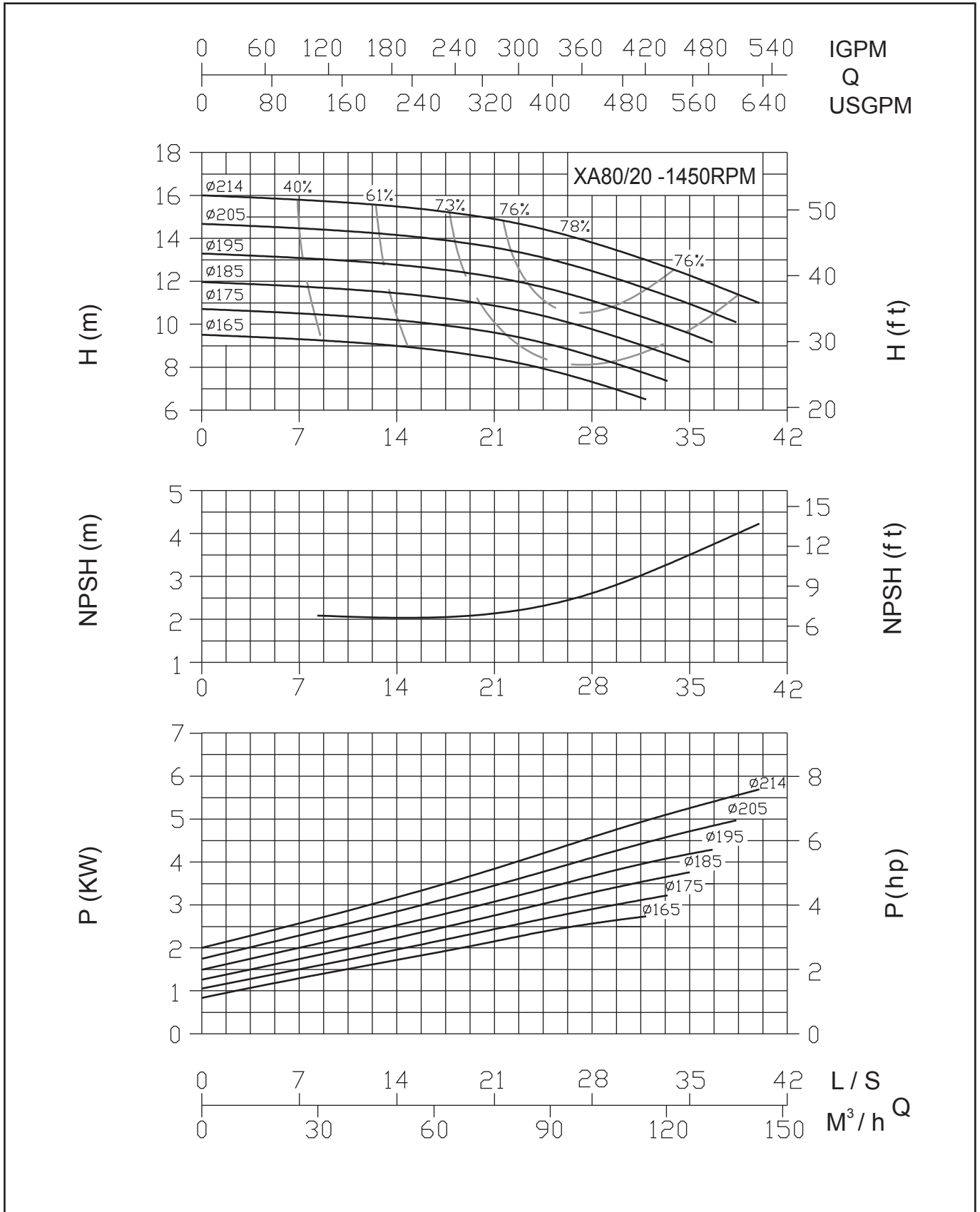



# END SUCTION PUMPS PERFORMANCE CURVES XA SERIES

## XA80/20-1750RPM (60HZ)

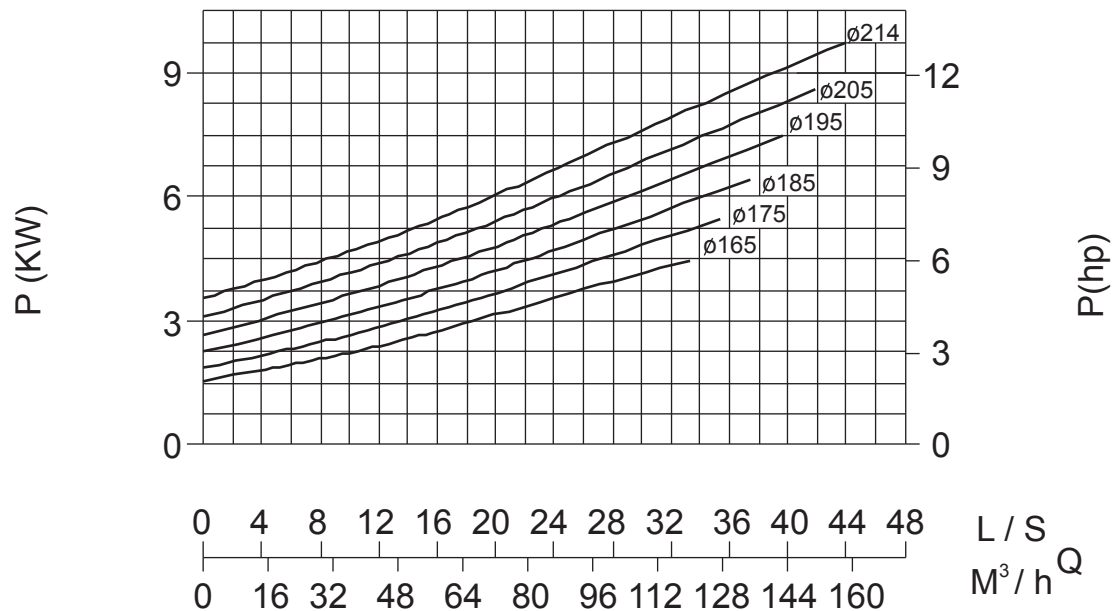
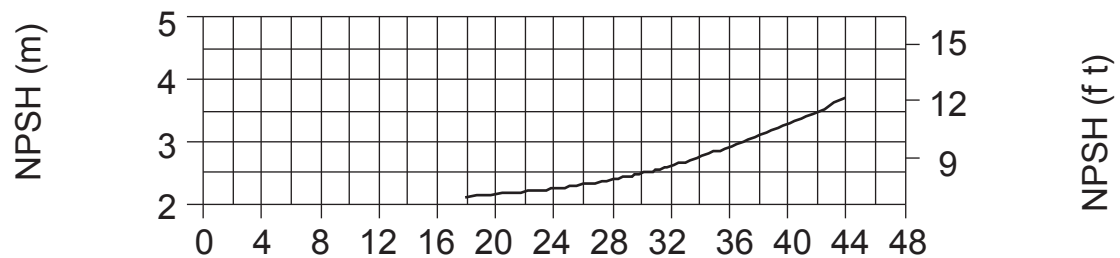
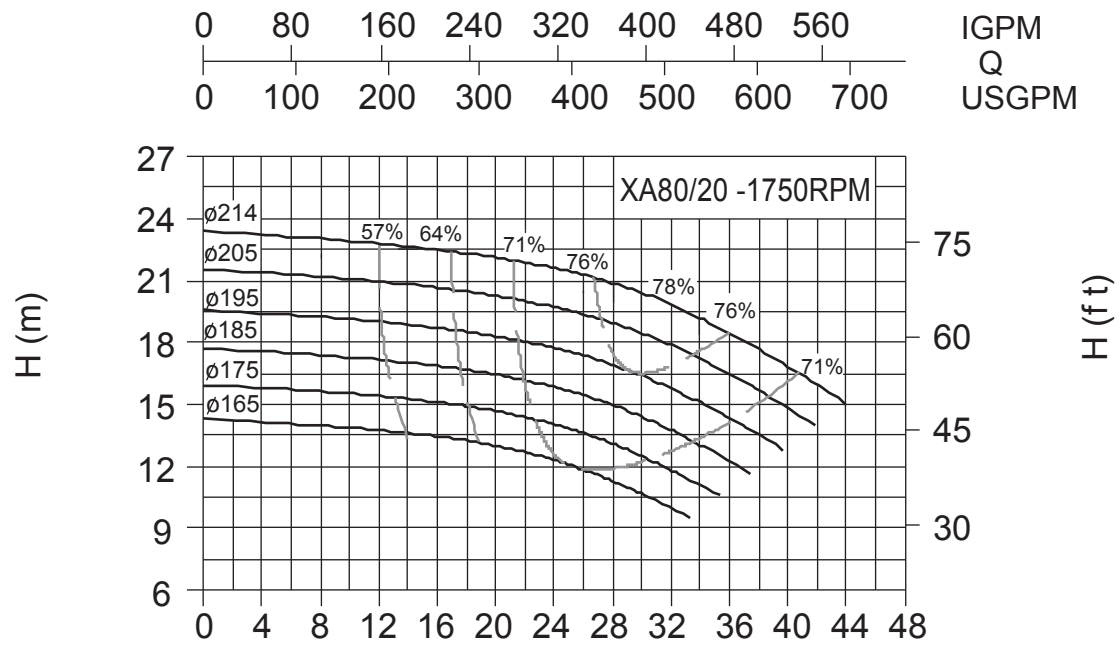

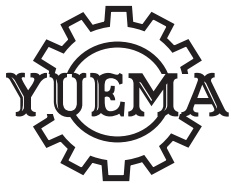

# END SUCTION PUMPS PERFORMANCE CURVES XA SERIES

## XA80/26-1450RPM (50HZ)

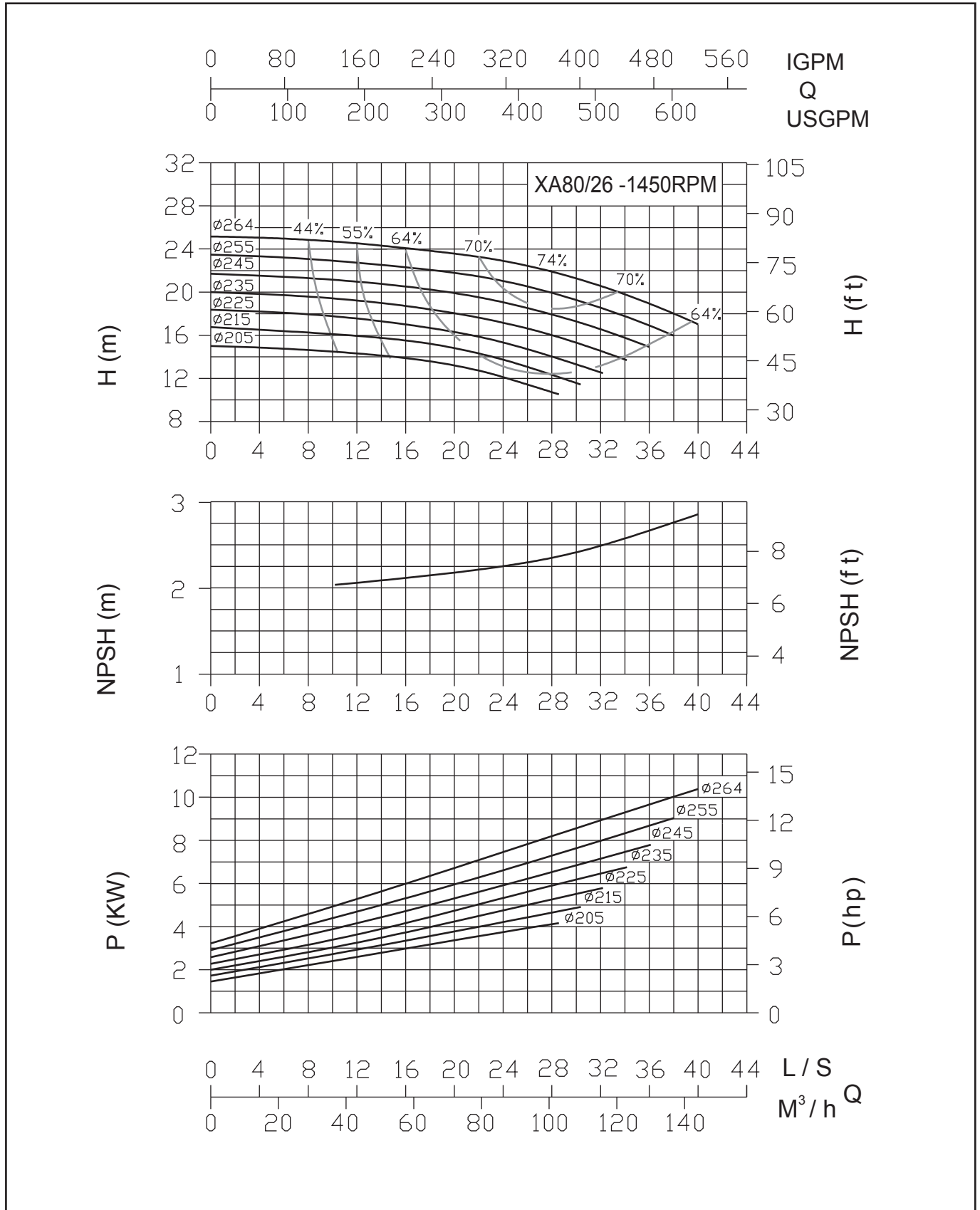



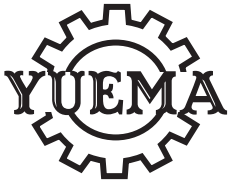

# END SUCTION PUMPS PERFORMANCE CURVES XA SERIES

## XA80/26-1750RPM (60HZ)

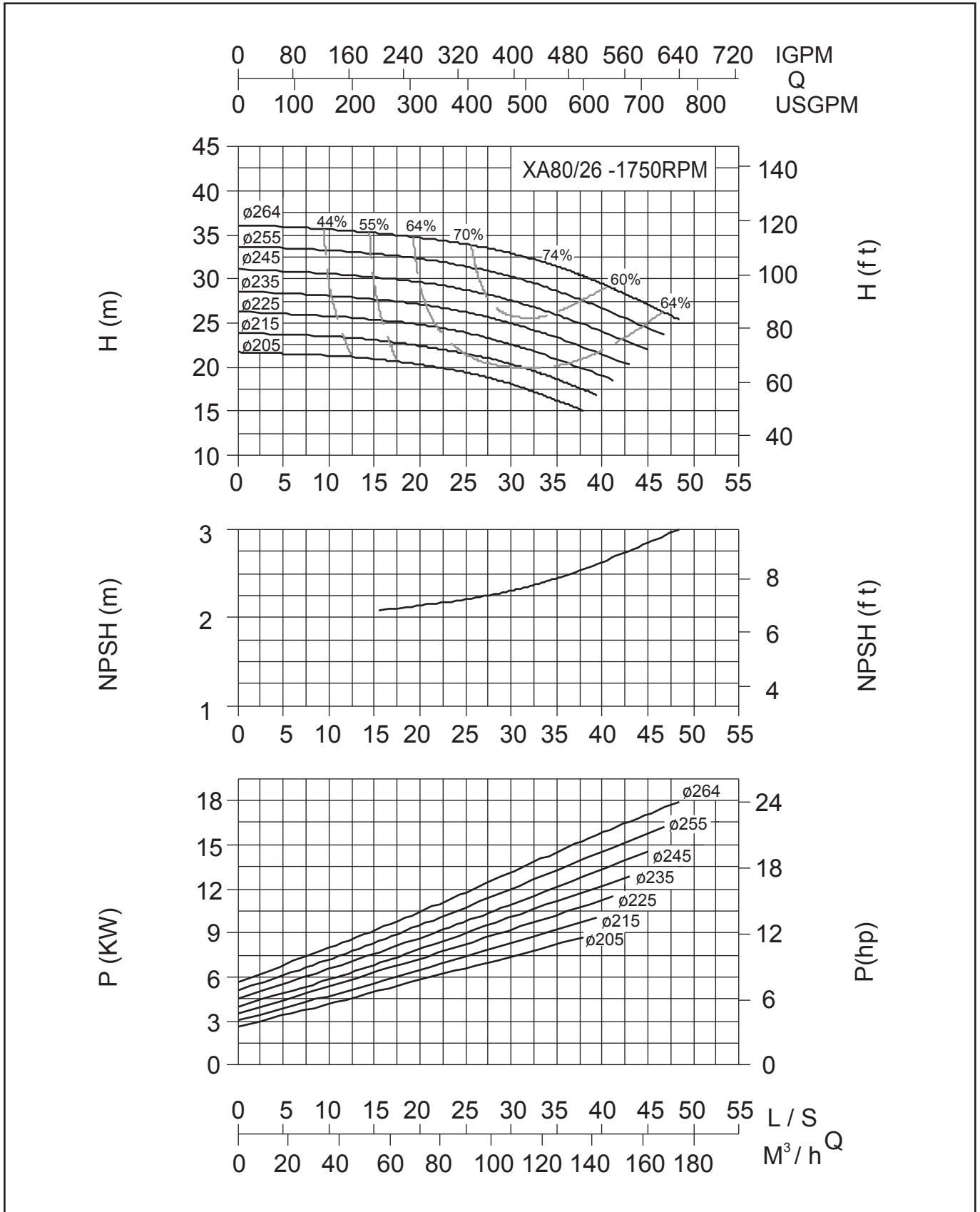

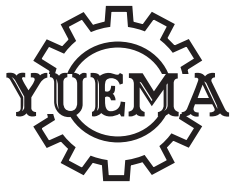

# END SUCTION PUMPS PERFORMANCE CURVES XA SERIES

## XA80/32-1450RPM (50HZ)

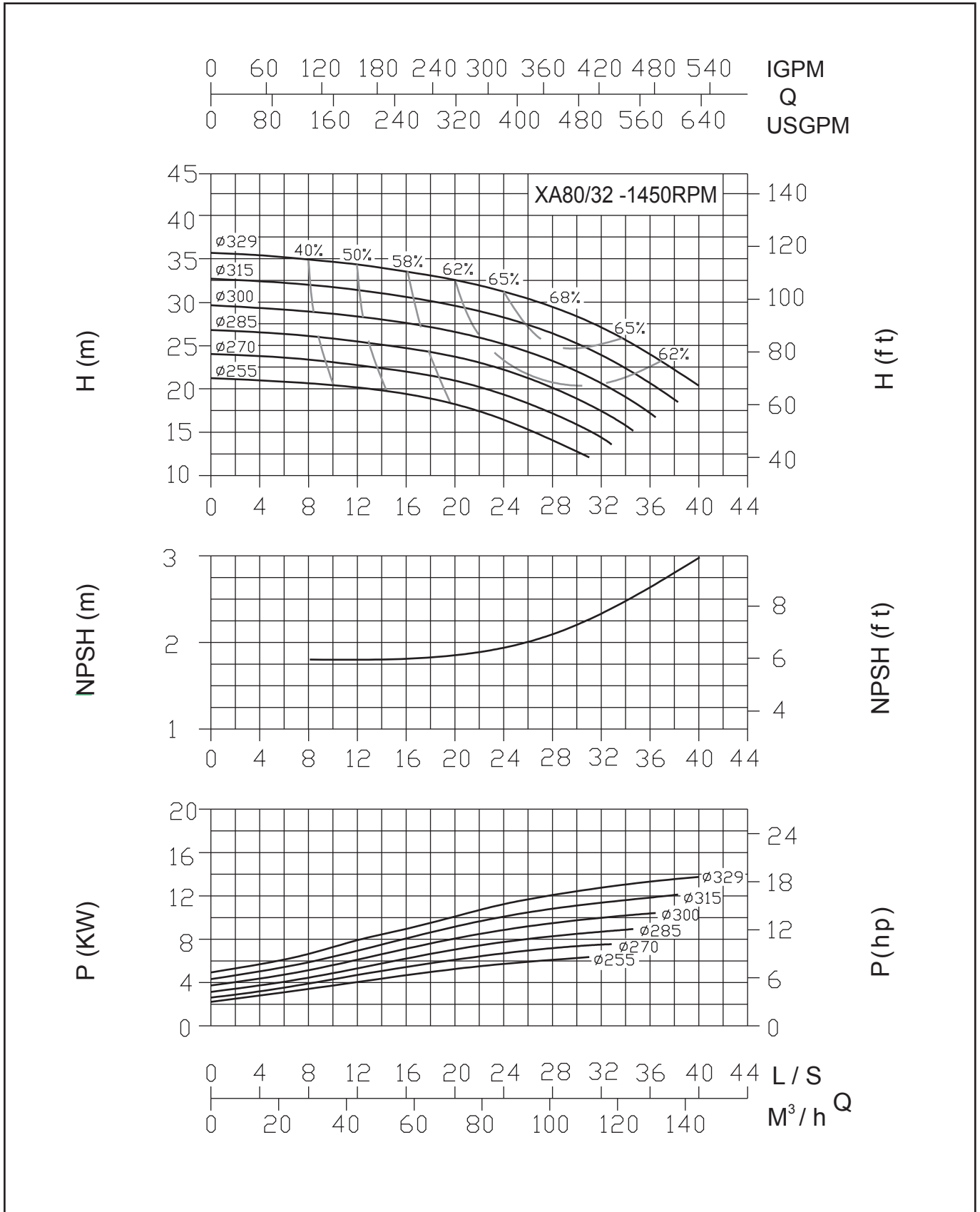

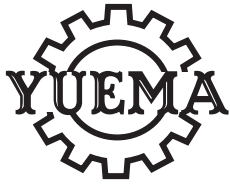

# END SUCTION PUMPS PERFORMANCE CURVES XA SERIES

## XA80/32-1750RPM (60HZ)

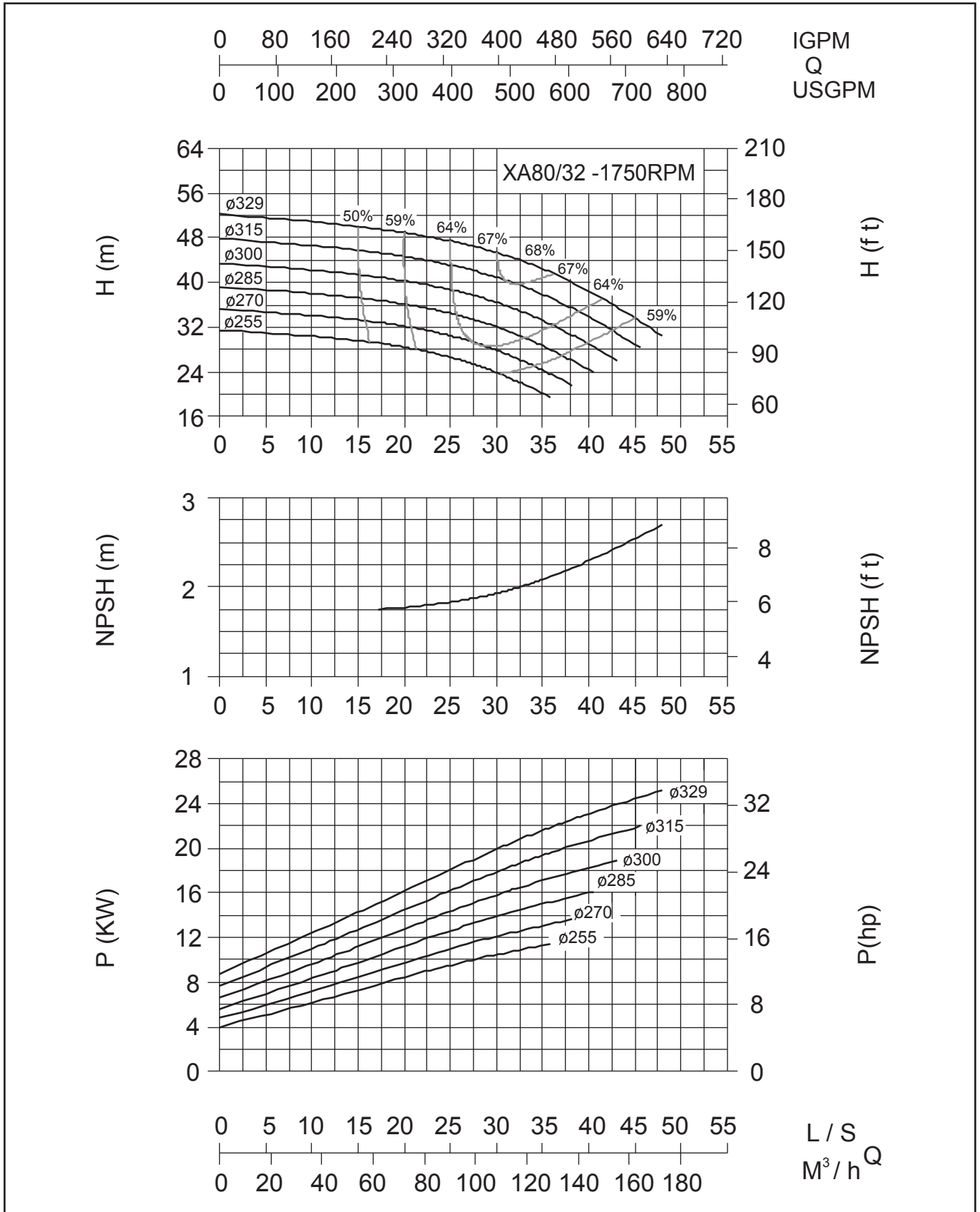



# END SUCTION PUMPS PERFORMANCE CURVES XA SERIES

## XA 80/40-1450RPM (50HZ)

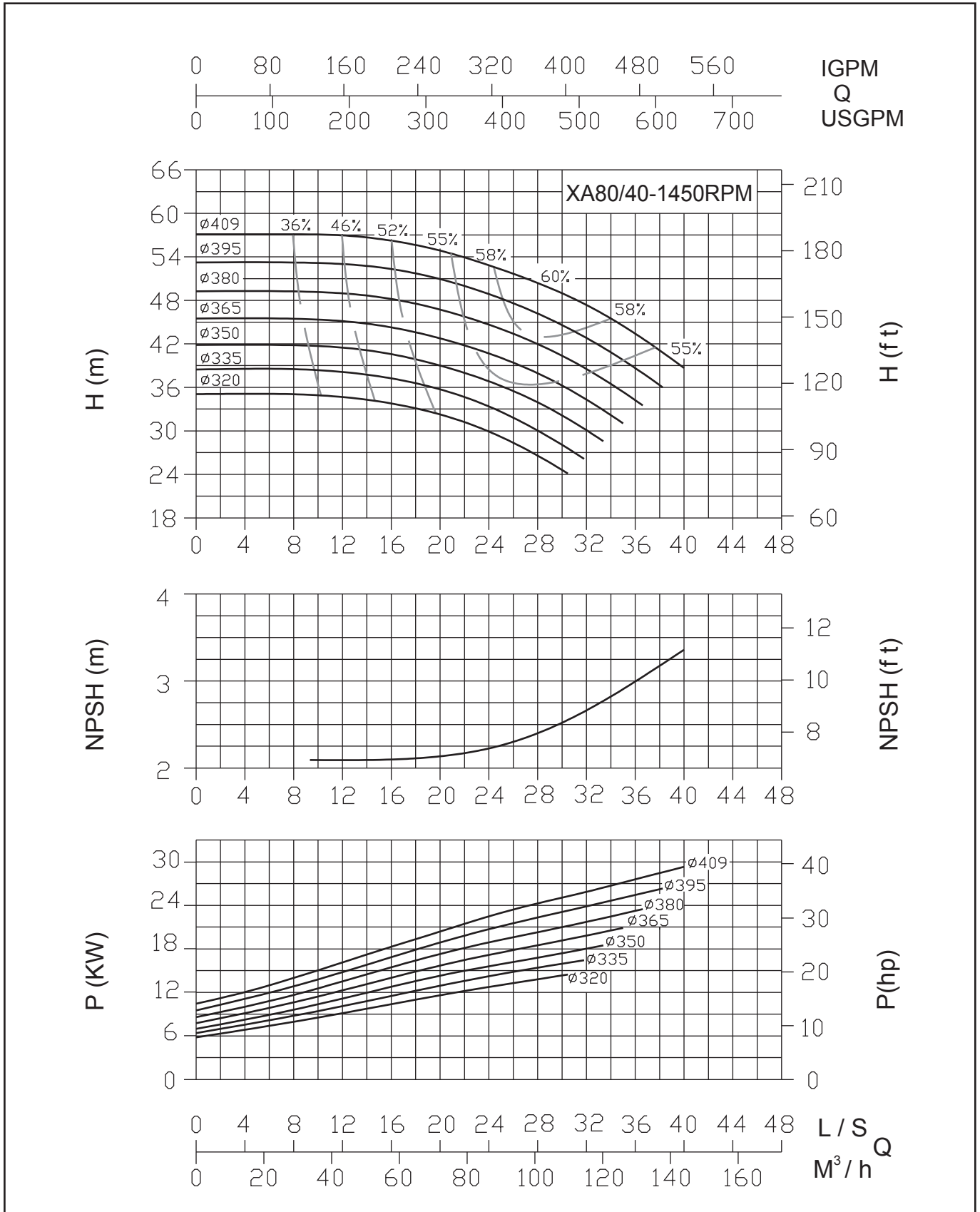



# END SUCTION PUMPS PERFORMANCE CURVES XA SERIES

## XA80/32N-1750RPM (60HZ)

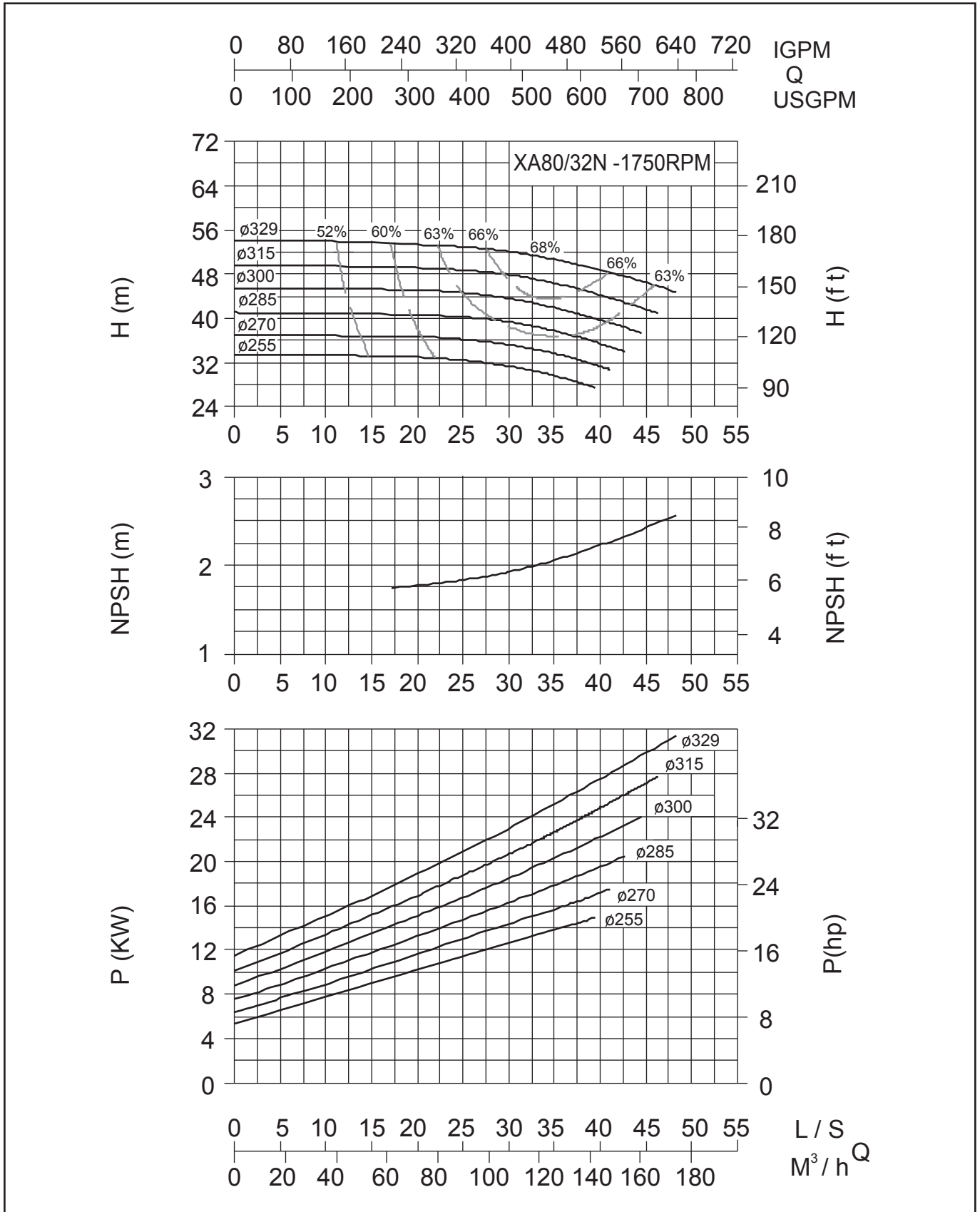



# END SUCTION PUMPS PERFORMANCE CURVES XA SERIES

## XA100/16-1450RPM (50HZ)

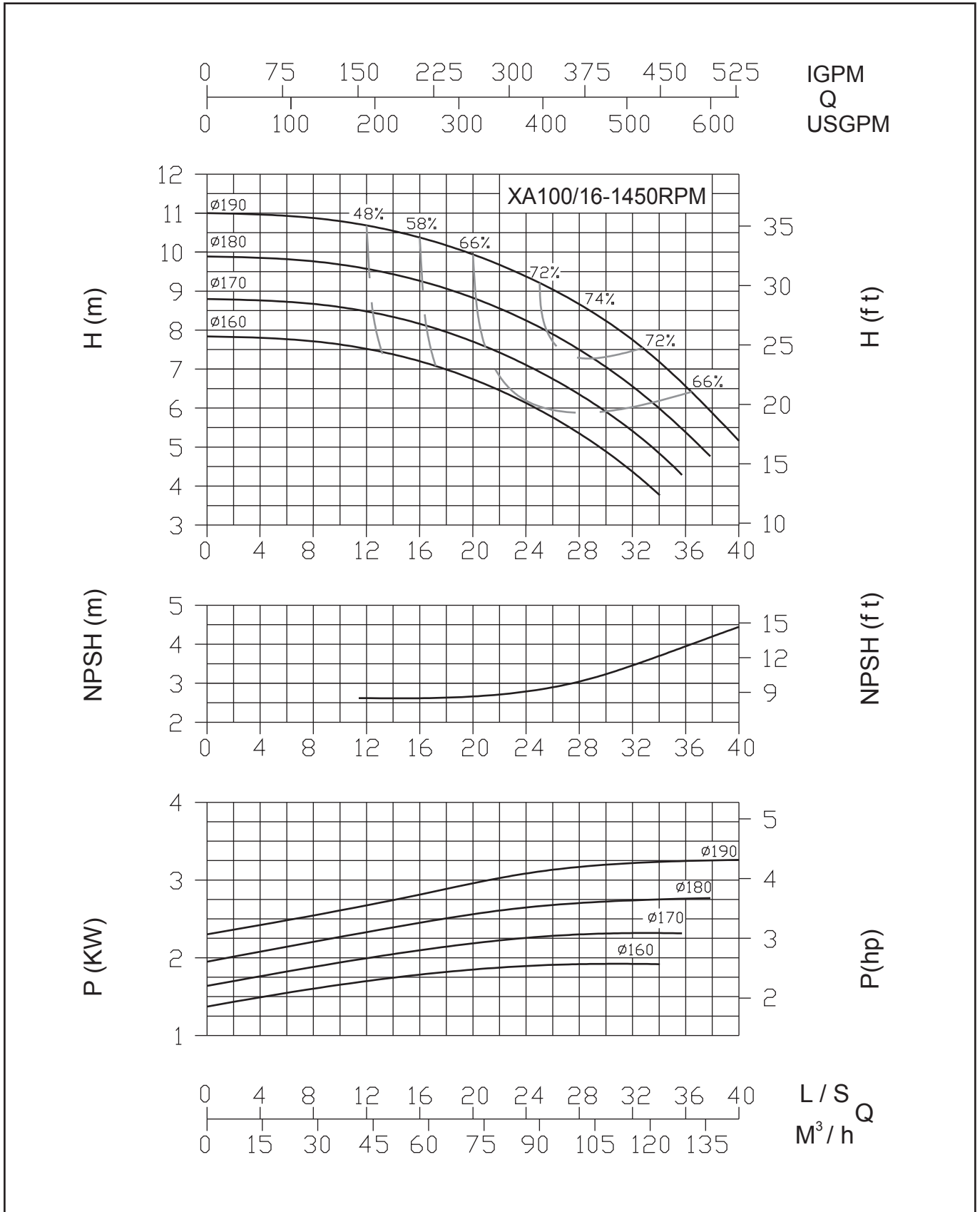

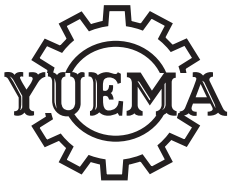

# END SUCTION PUMPS PERFORMANCE CURVES XA SERIES

## XA80/40-1750 (60HZ)

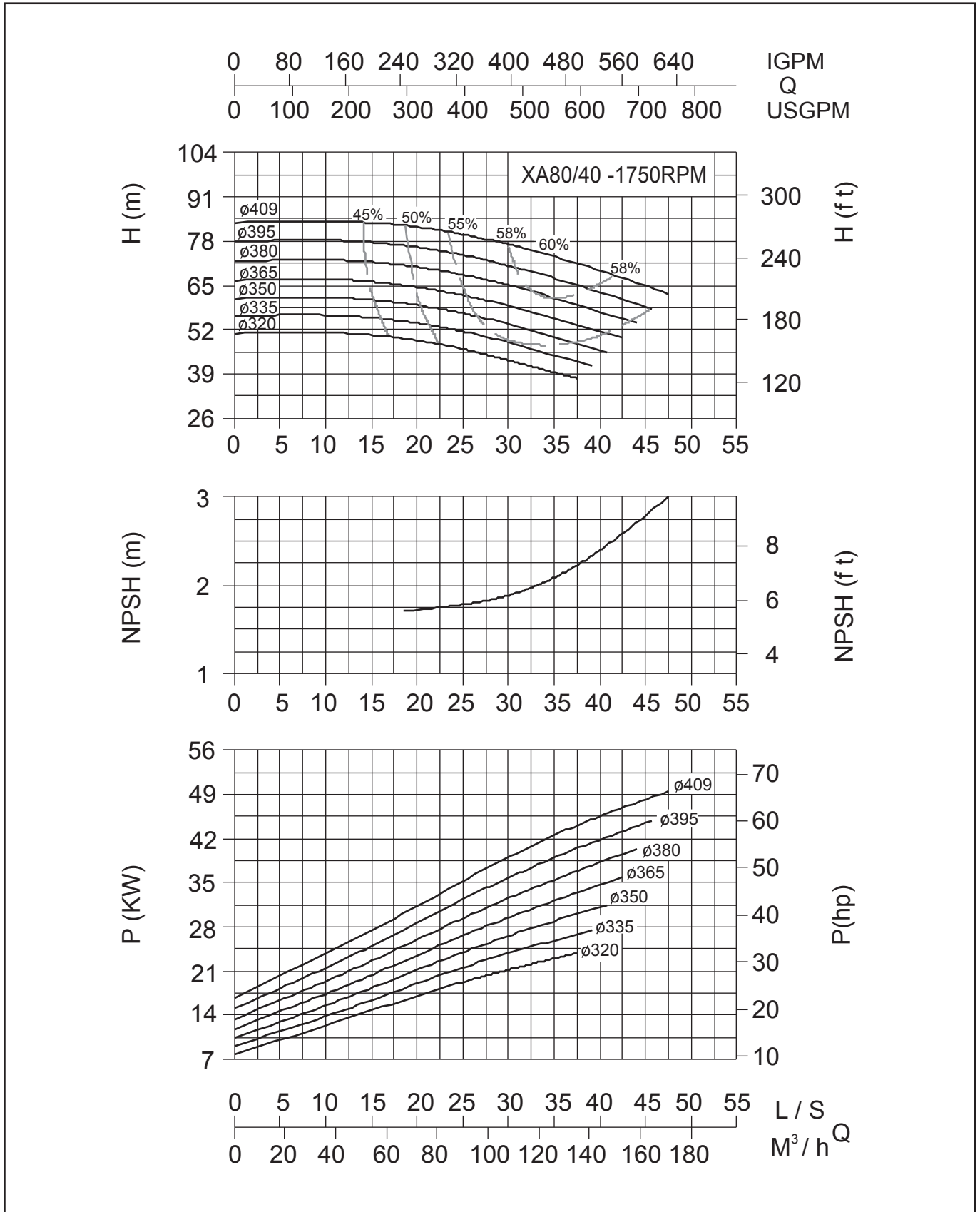



# END SUCTION PUMPS PERFORMANCE CURVES XA SERIES

## XA100/20-1450RPM (50HZ)

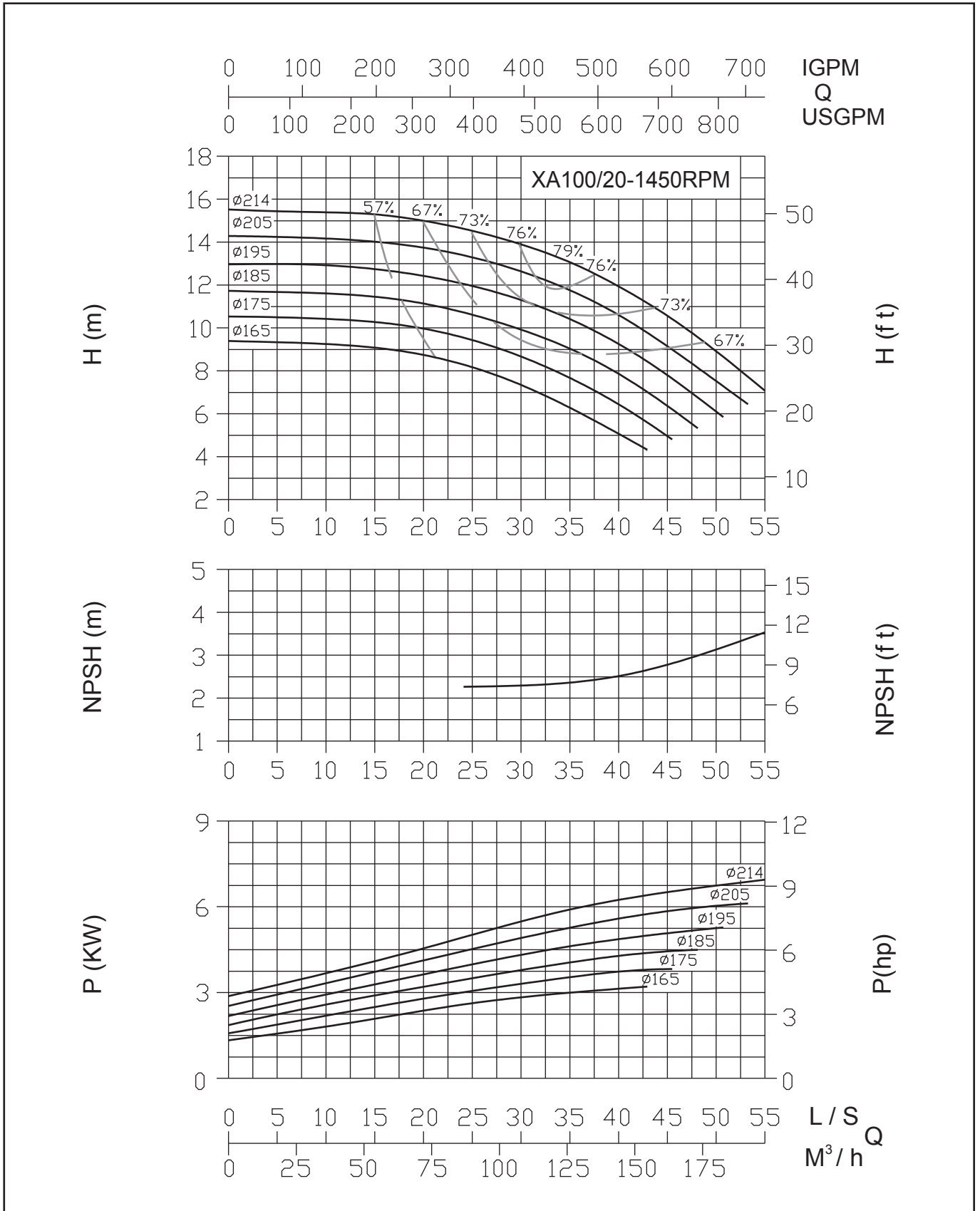



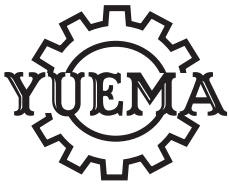

# END SUCTION PUMPS PERFORMANCE CURVES XA SERIES

## XA100/16-1750RPM (60HZ)

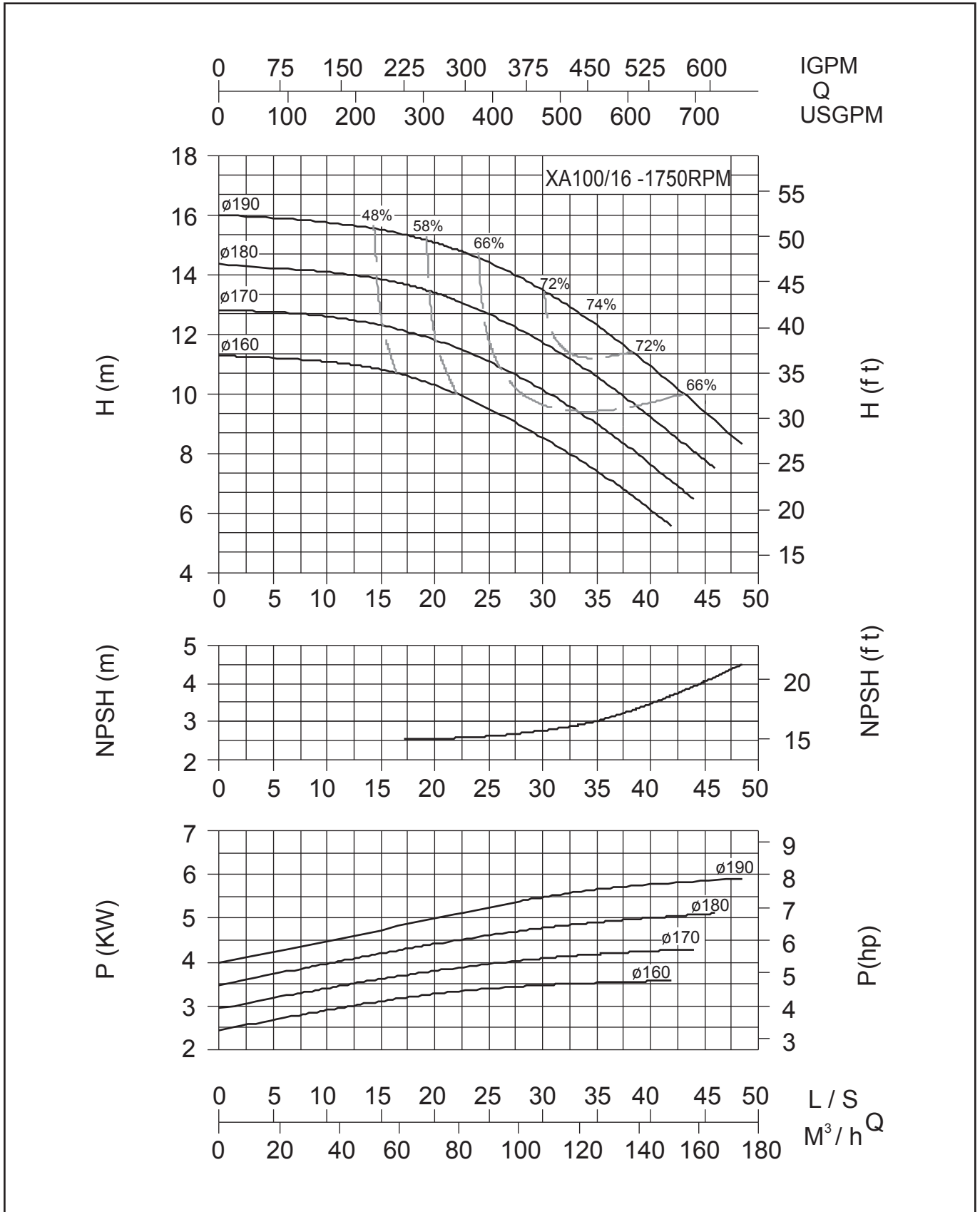



# END SUCTION PUMPS PERFORMANCE CURVES XA SERIES

## XA100/26-1450 (50HZ)

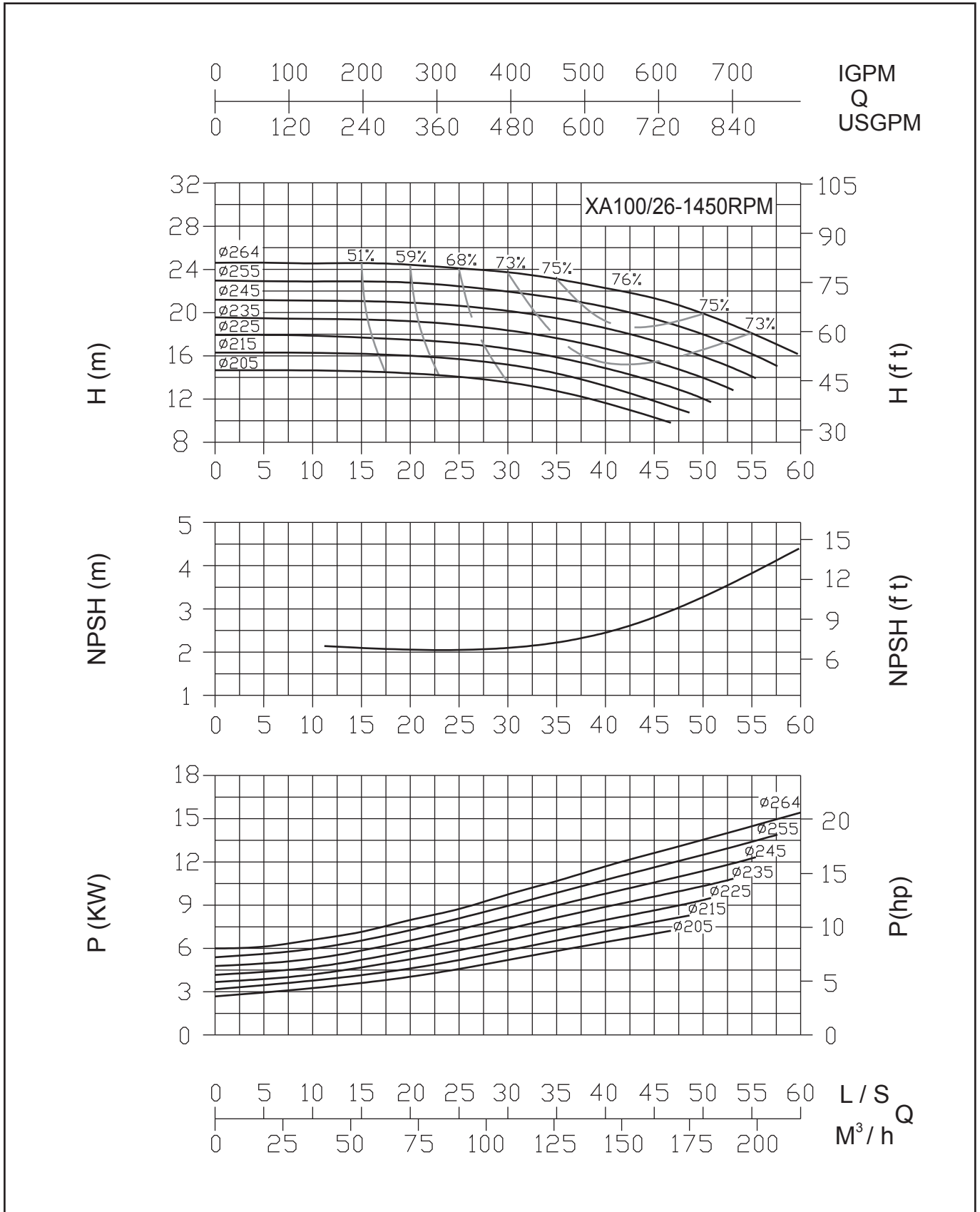

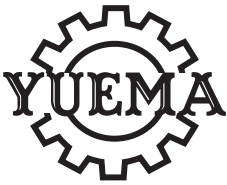

# END SUCTION PUMPS PERFORMANCE CURVES XA SERIES

## XA100/20-1750RPM (60HZ)

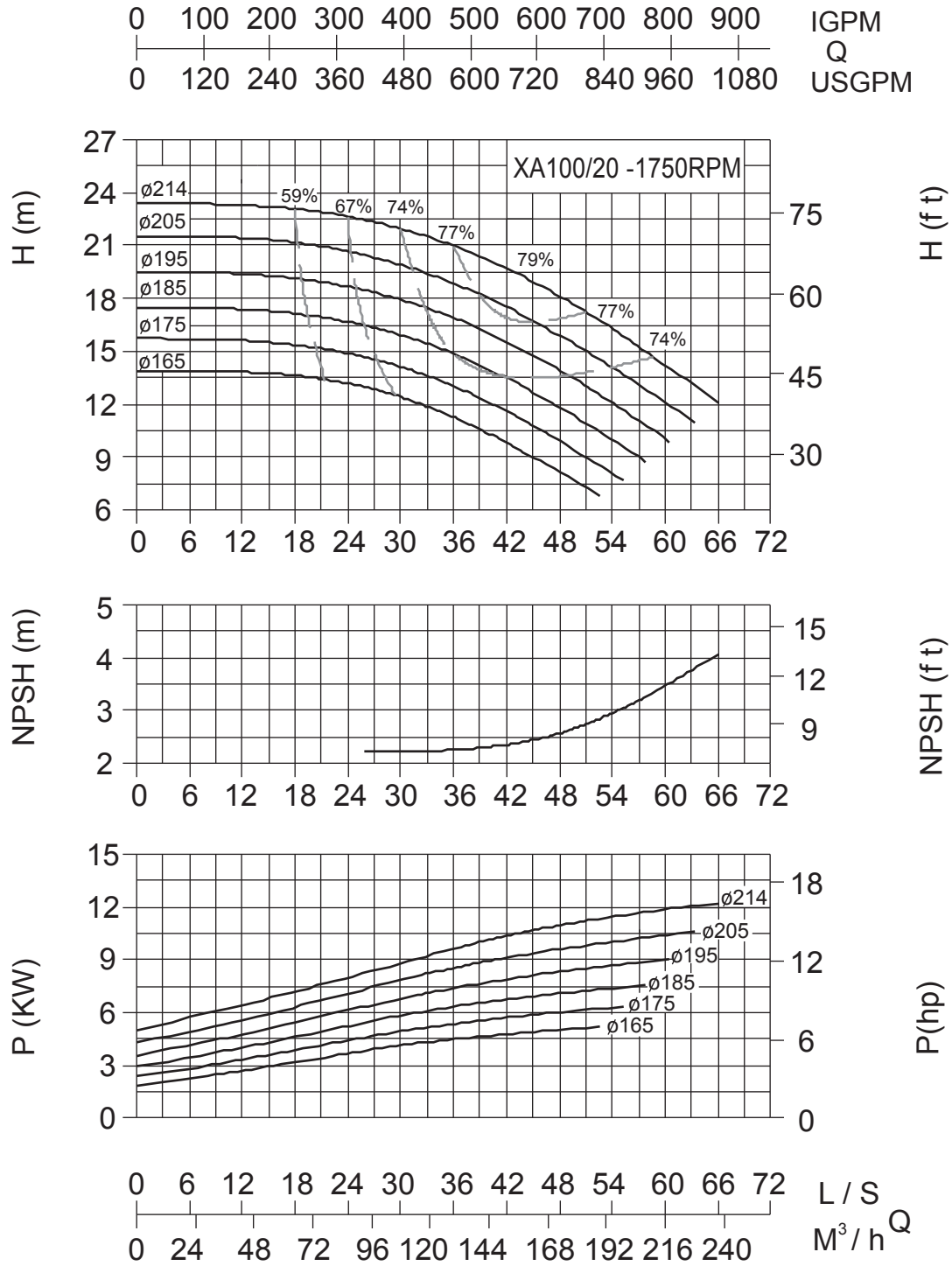



# END SUCTION PUMPS PERFORMANCE CURVES XA SERIES

## XA100/32-1450RPM (50HZ)

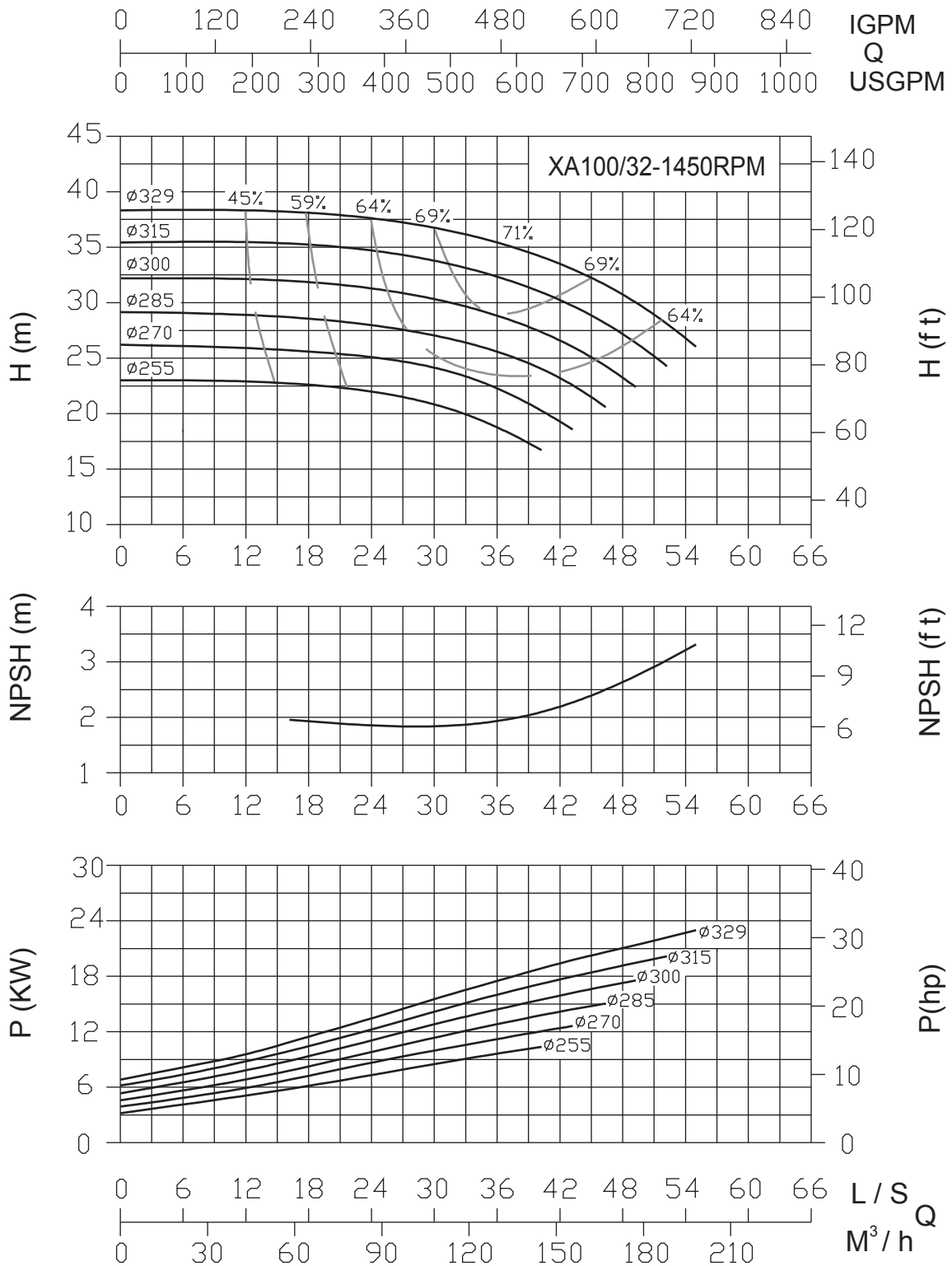

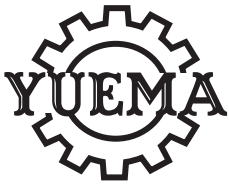

# END SUCTION PUMPS PERFORMANCE CURVES XA SERIES

## XA100/26-1750RPM (60HZ)

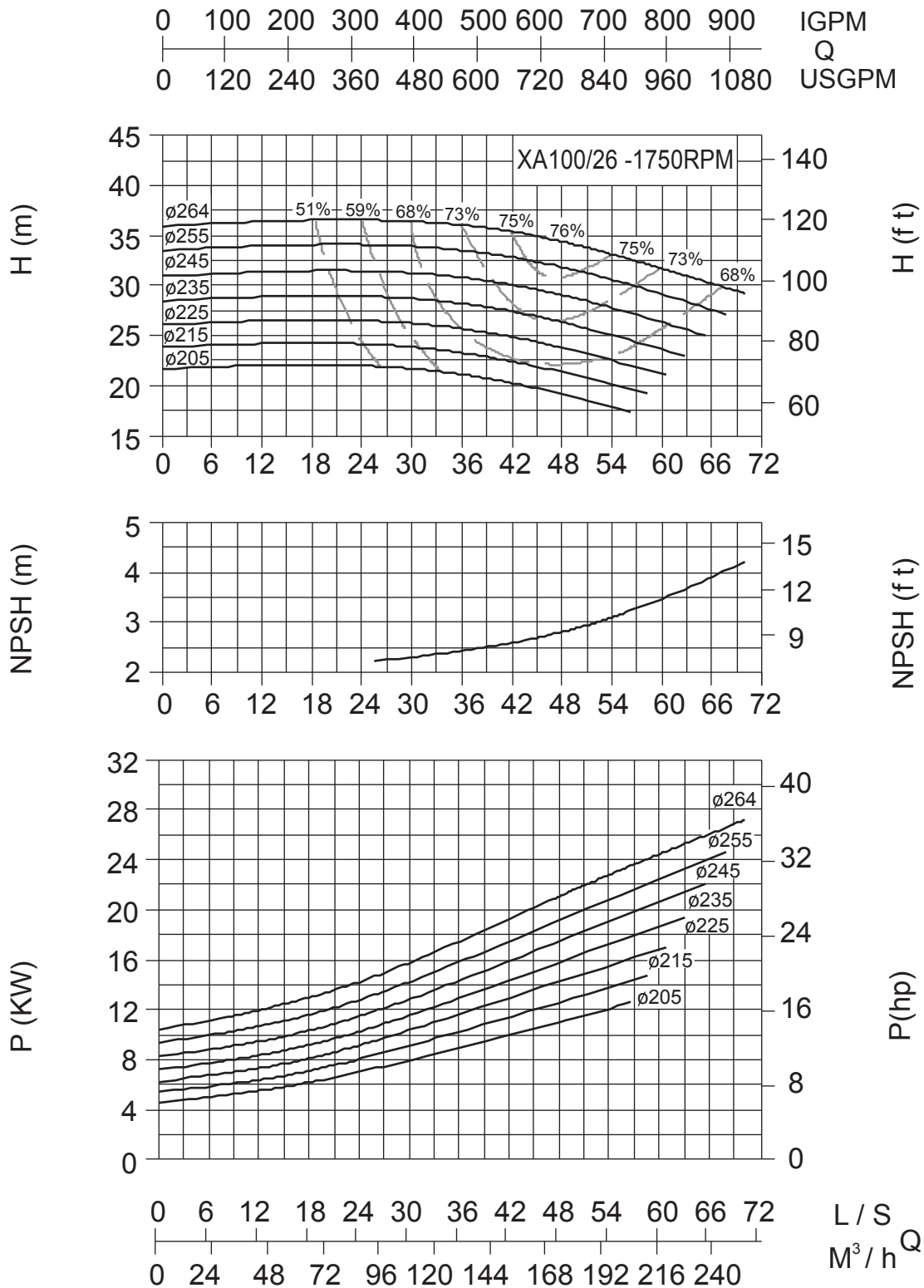

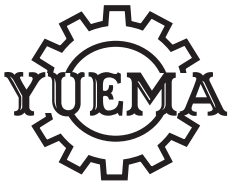

# END SUCTION PUMPS PERFORMANCE CURVES XA SERIES

## XA100/40-1450RPM (50HZ)

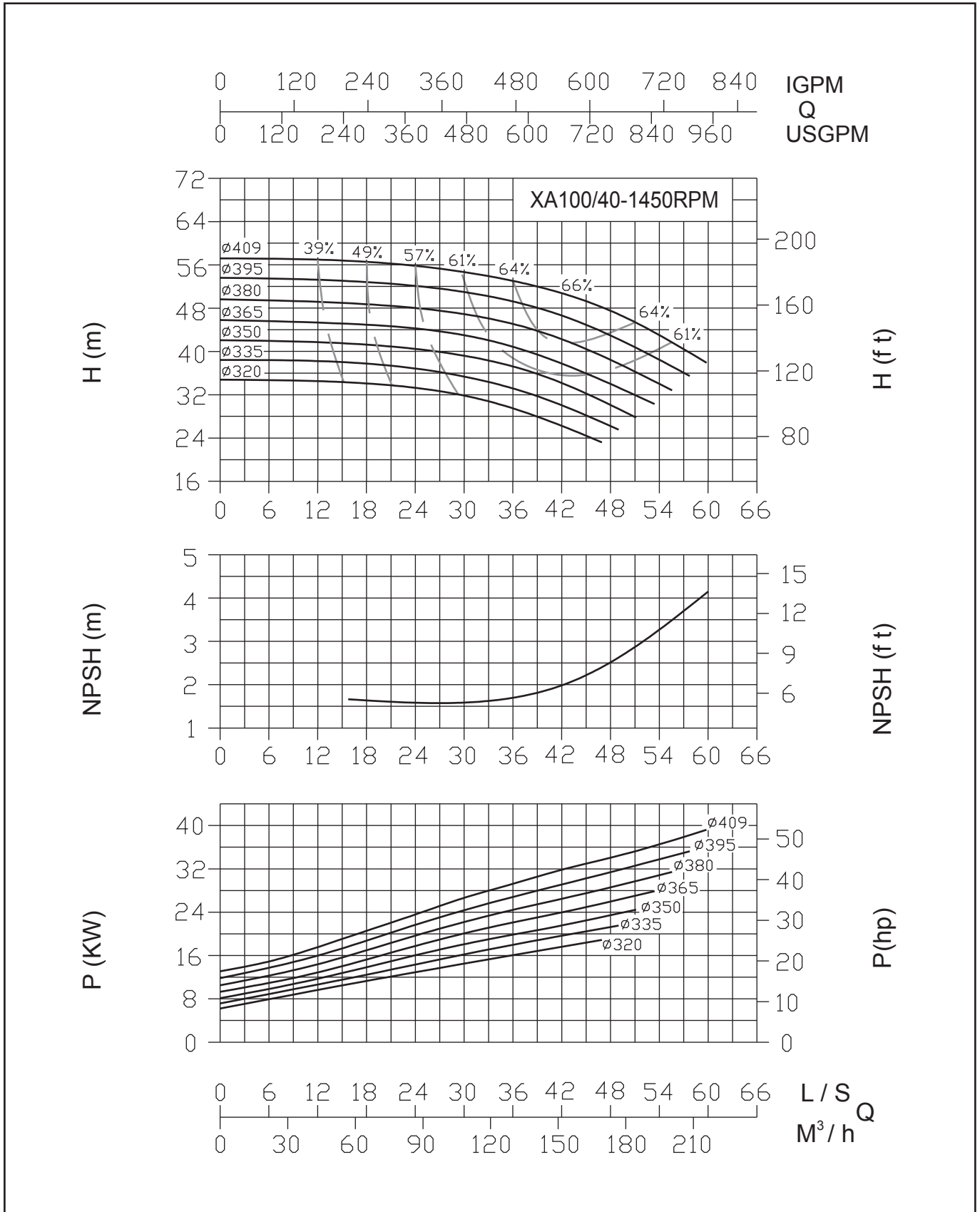



# END SUCTION PUMPS PERFORMANCE CURVES XA SERIES

## XA100/32-1750RPM (60HZ)

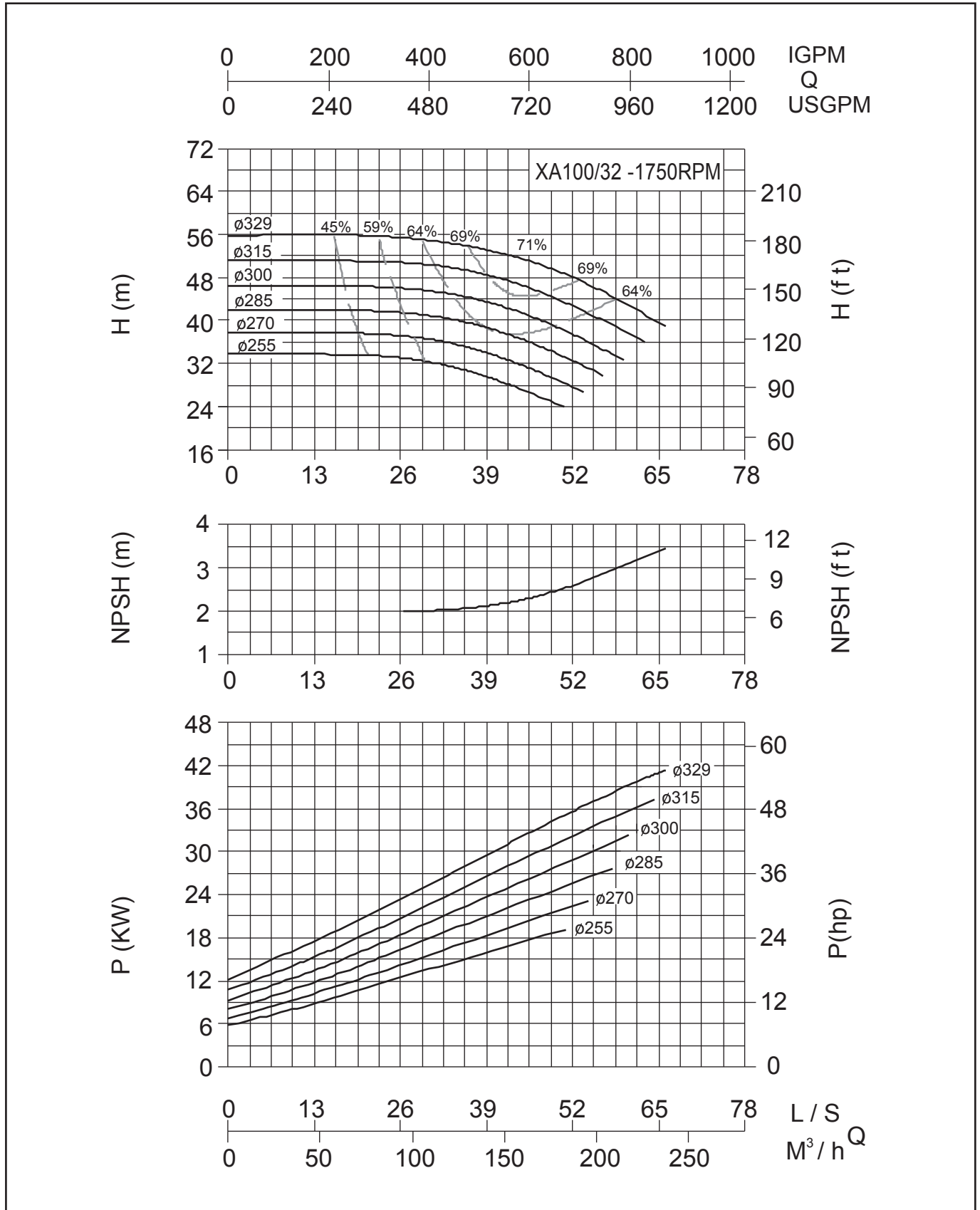



# END SUCTION PUMPS PERFORMANCE CURVES XA SERIES

## XA125/20-1450RPM (50HZ)

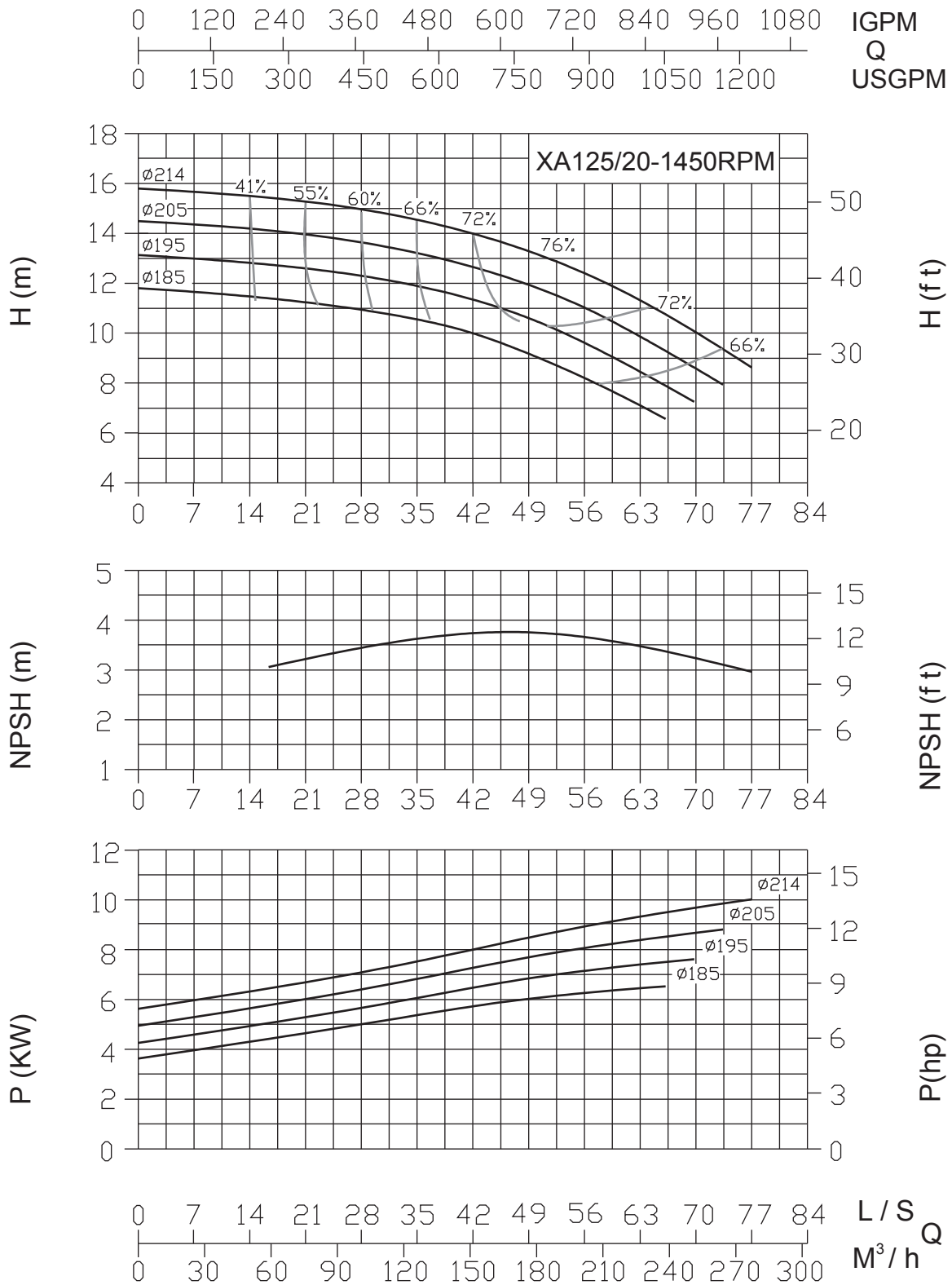





# END SUCTION PUMPS PERFORMANCE CURVES XA SERIES

## XA100/40-1750RPM (60HZ)

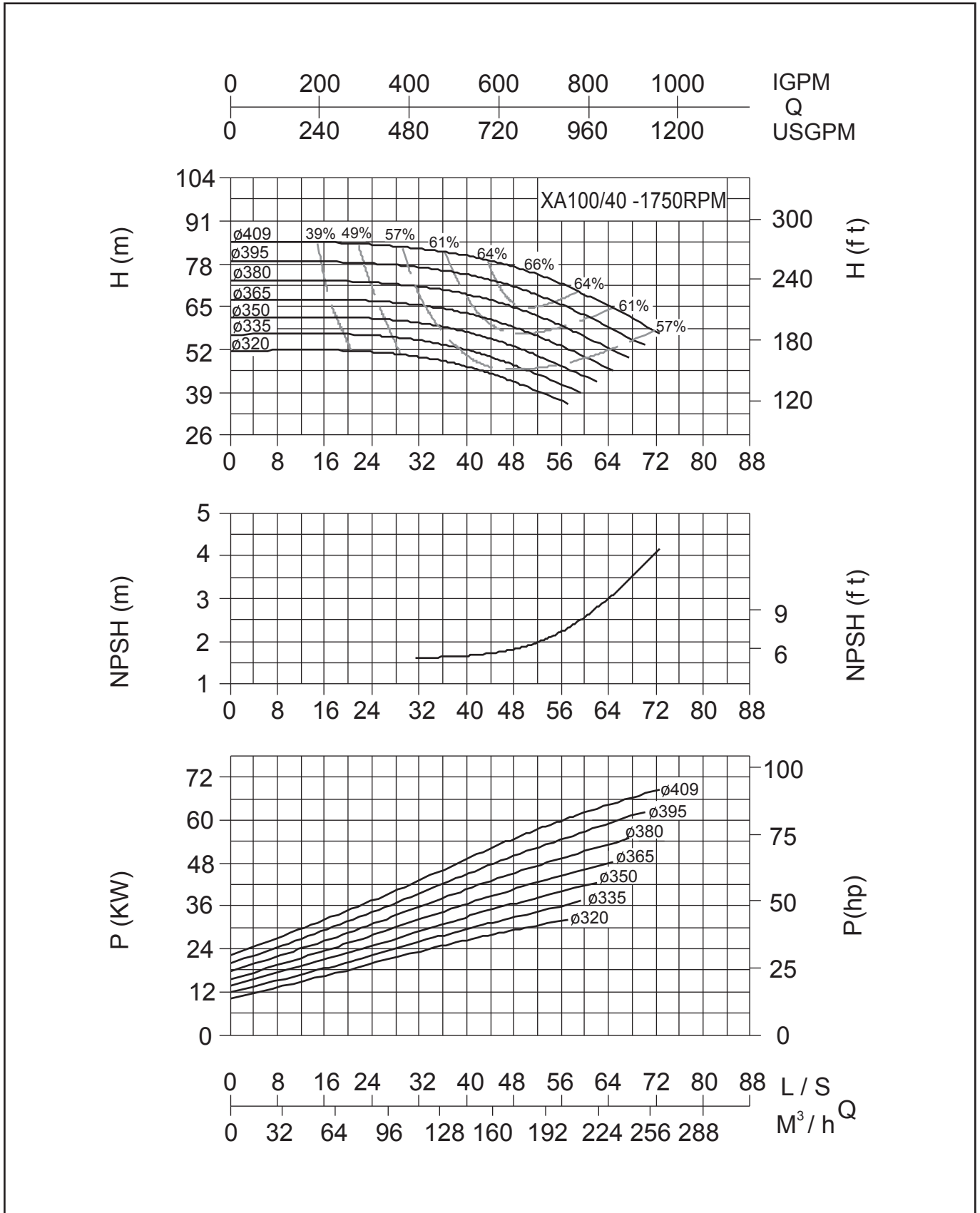



# END SUCTION PUMPS PERFORMANCE CURVES XA SERIES

## XA125/26-1450RPM (50HZ)

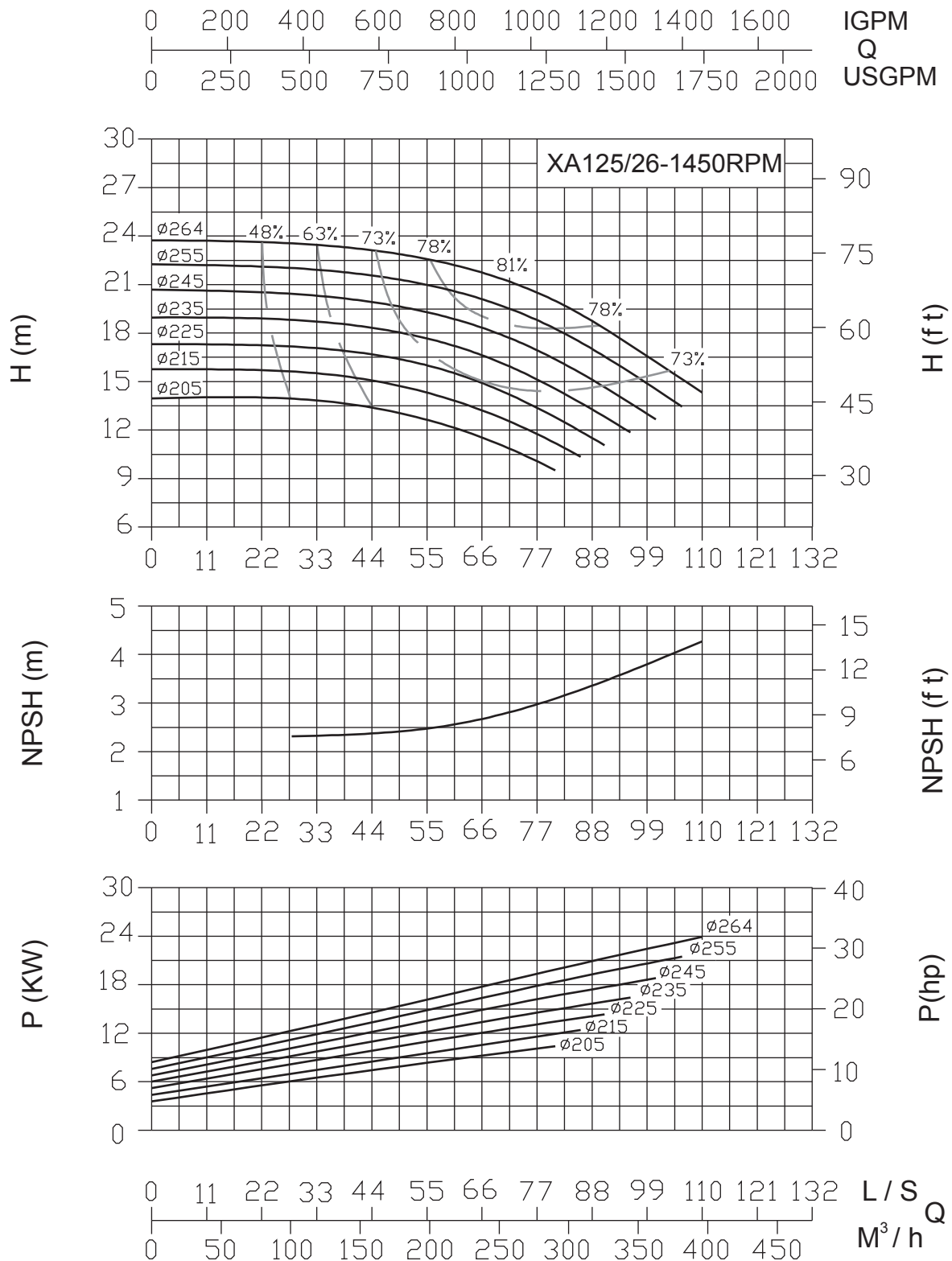

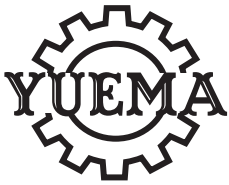

# END SUCTION PUMPS PERFORMANCE CURVES XA SERIES

## XA125/20-1750RPM (60HZ)

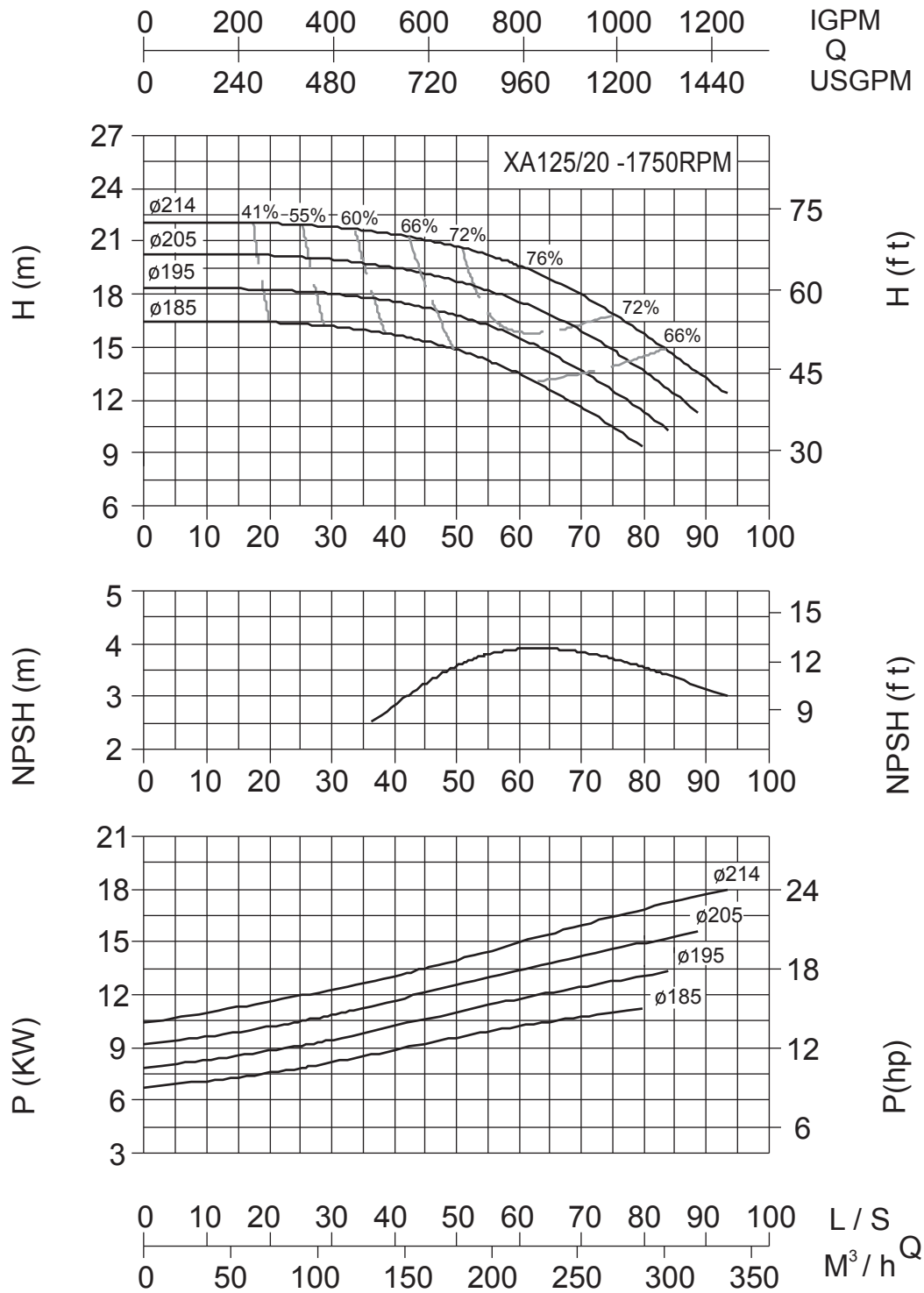



# END SUCTION PUMPS PERFORMANCE CURVES XA SERIES

## XA125/32-1450RPM (50HZ)

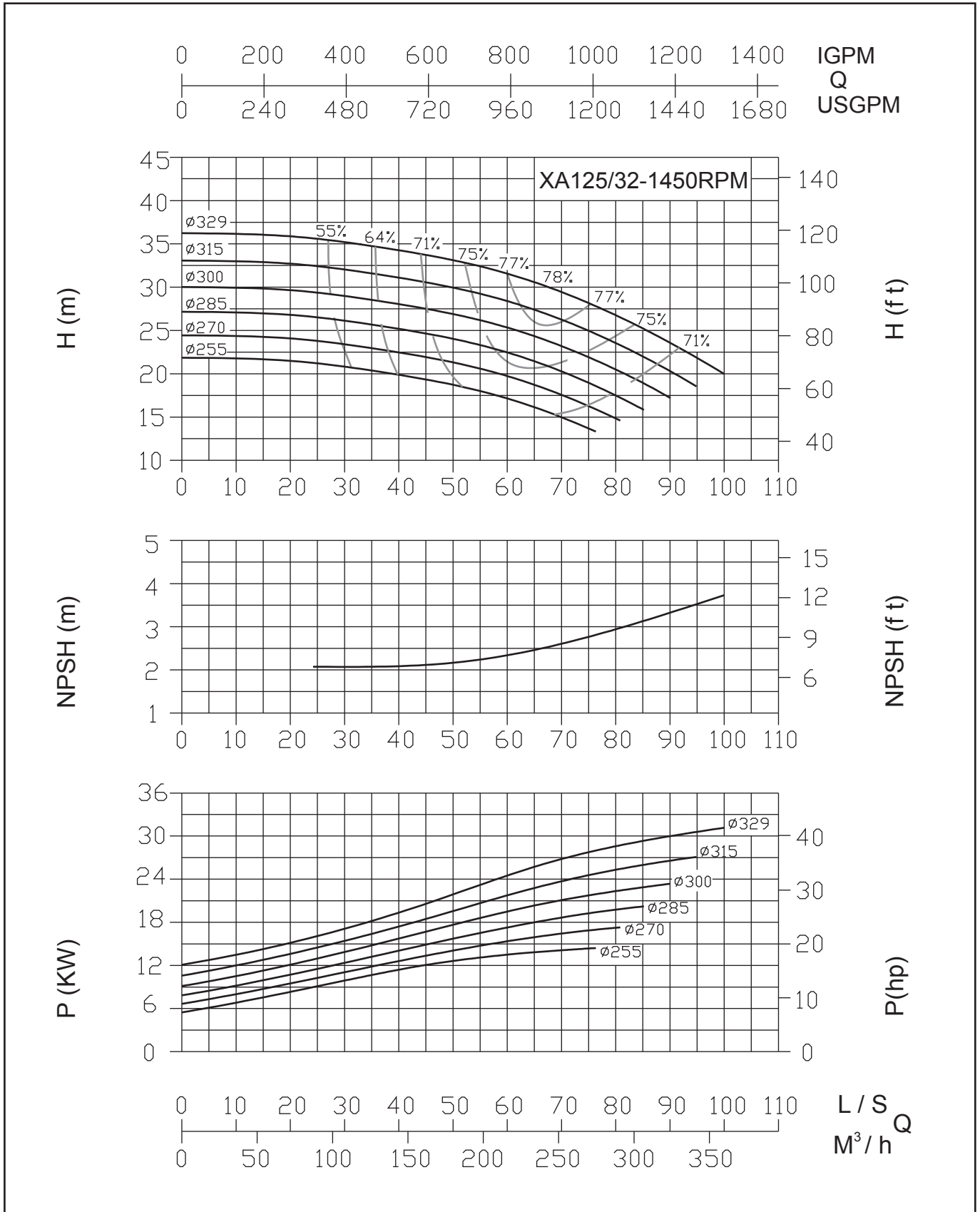



# END SUCTION PUMPS PERFORMANCE CURVES XA SERIES

## XA125/26-1750RPM (60HZ)

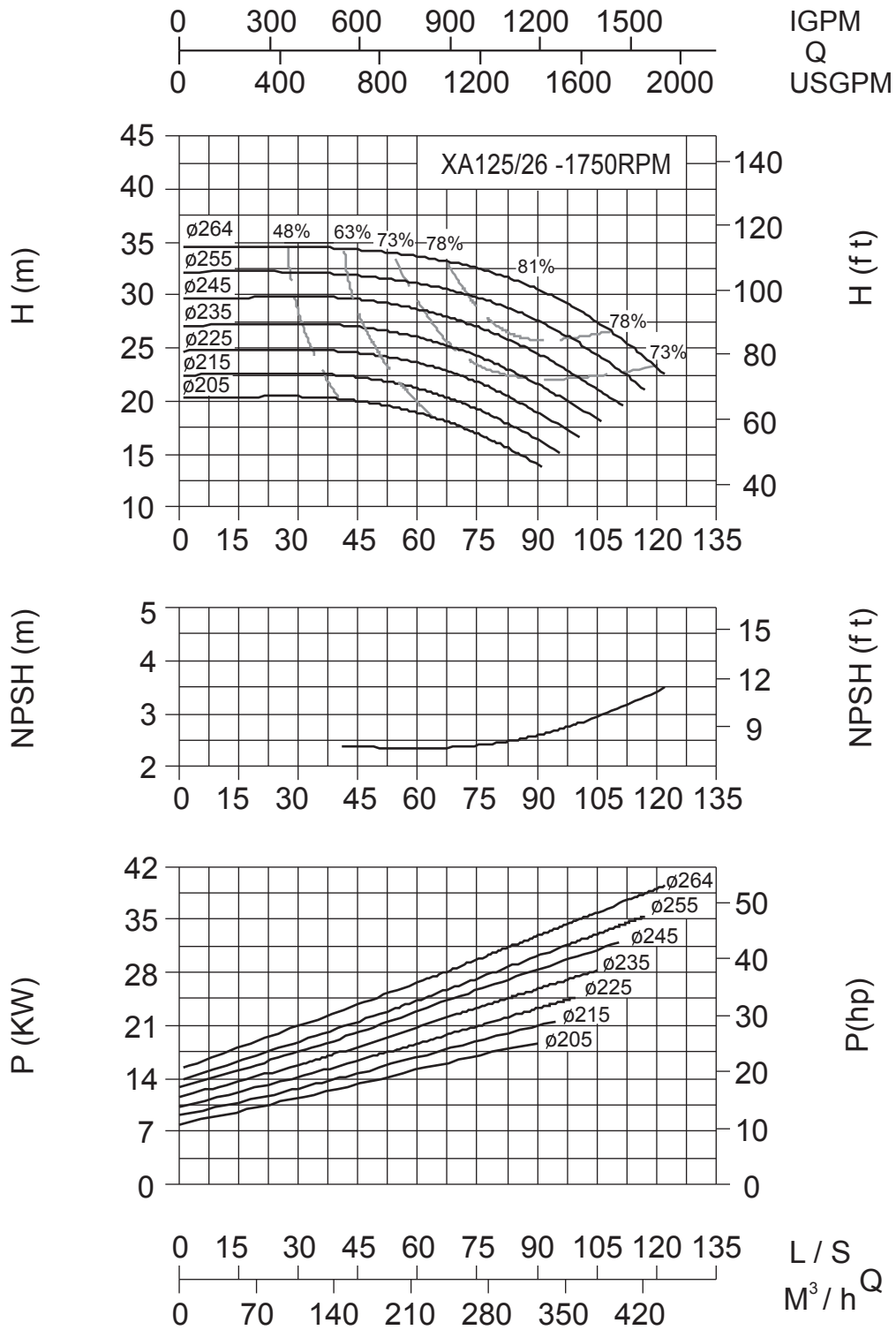

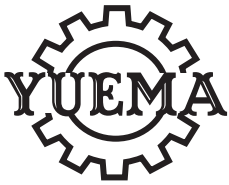

# END SUCTION PUMPS PERFORMANCE CURVES XA SERIES

## XA125/40-1450RPM (50HZ)

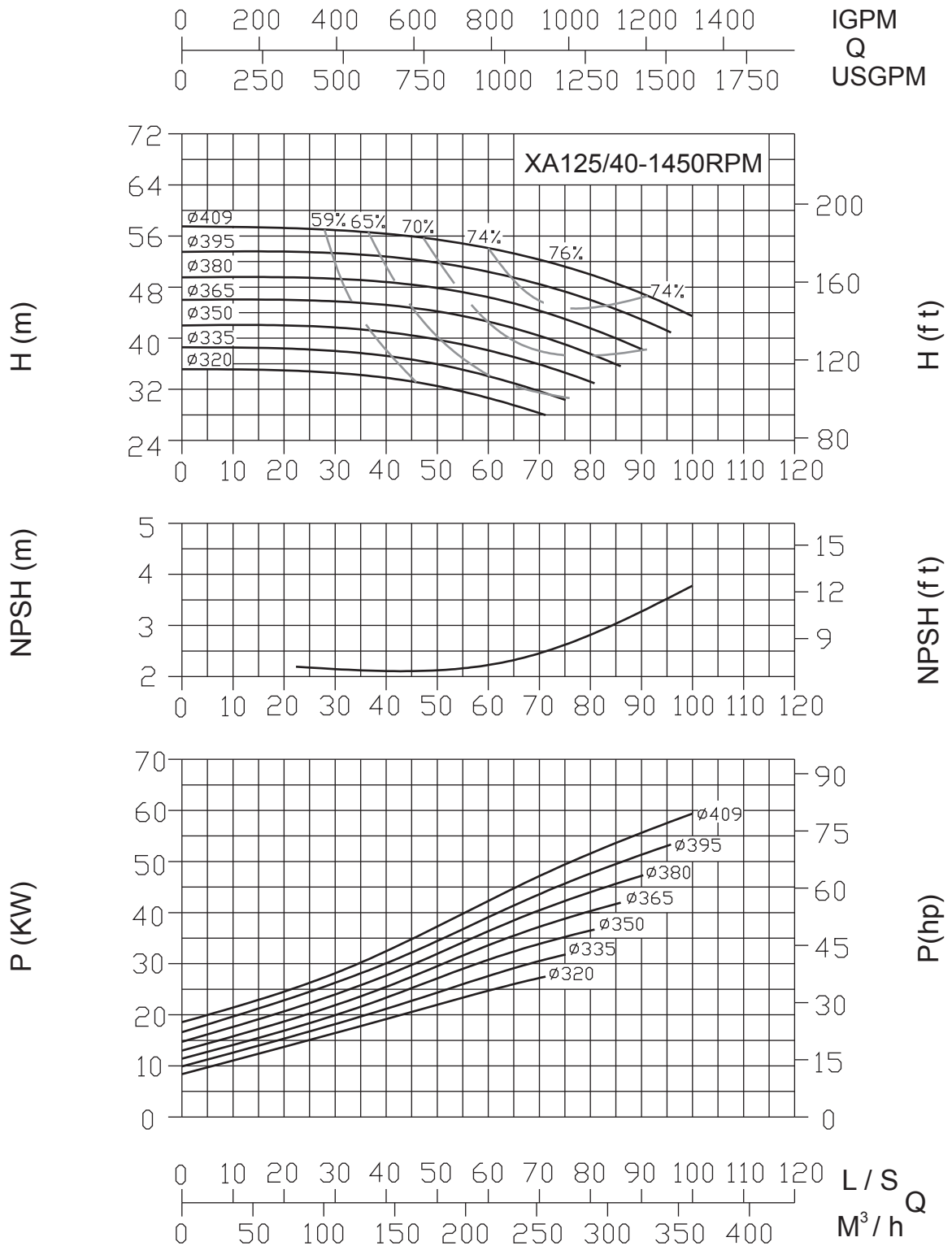

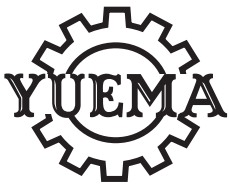

# END SUCTION PUMPS PERFORMANCE CURVES XA SERIES

## XA125/32-1750RPM (60HZ)

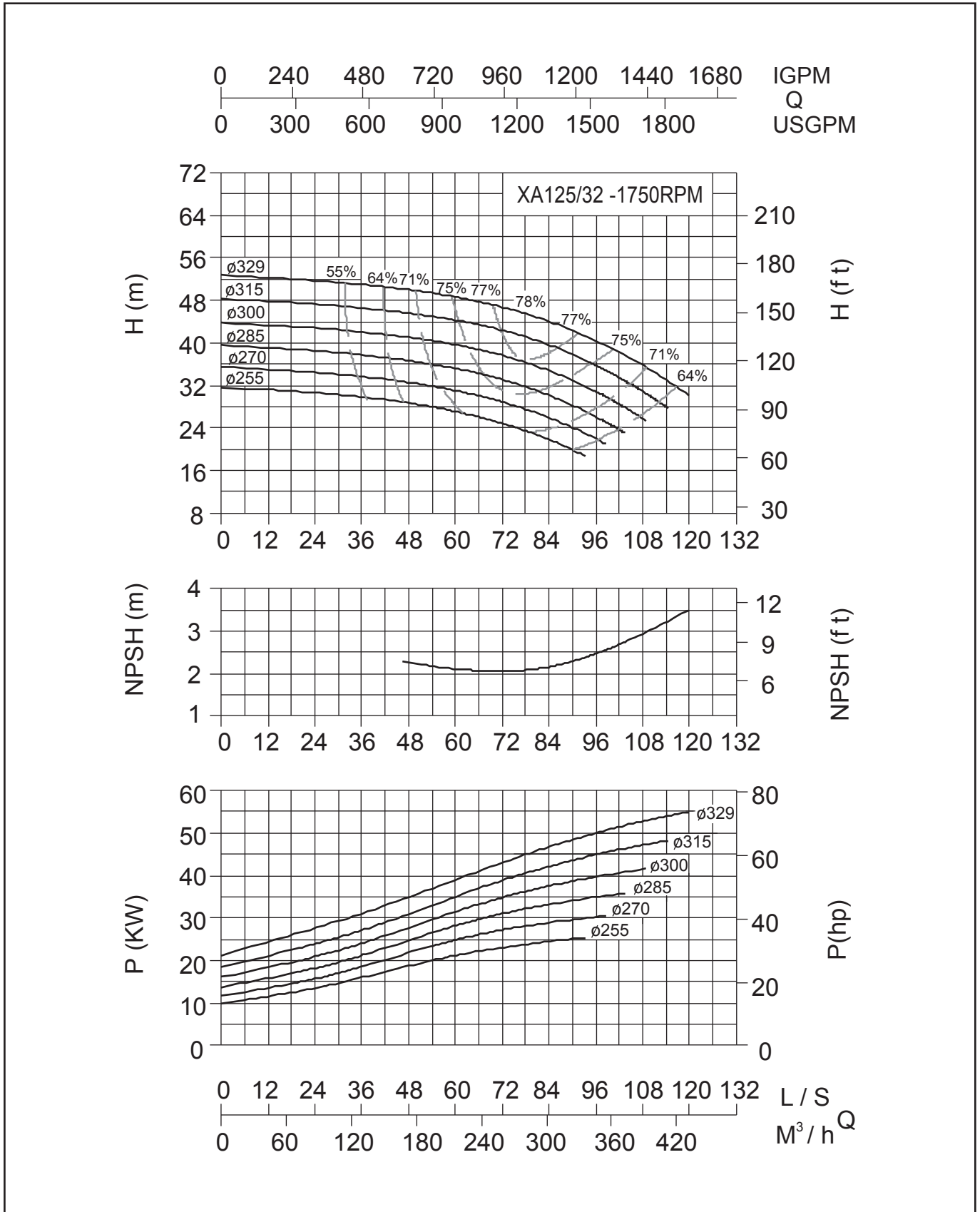

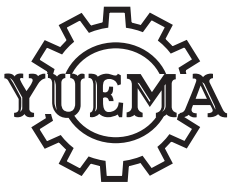

# END SUCTION PUMPS PERFORMANCE CURVES XA SERIES

## XA150/20-1450RPM (50HZ)

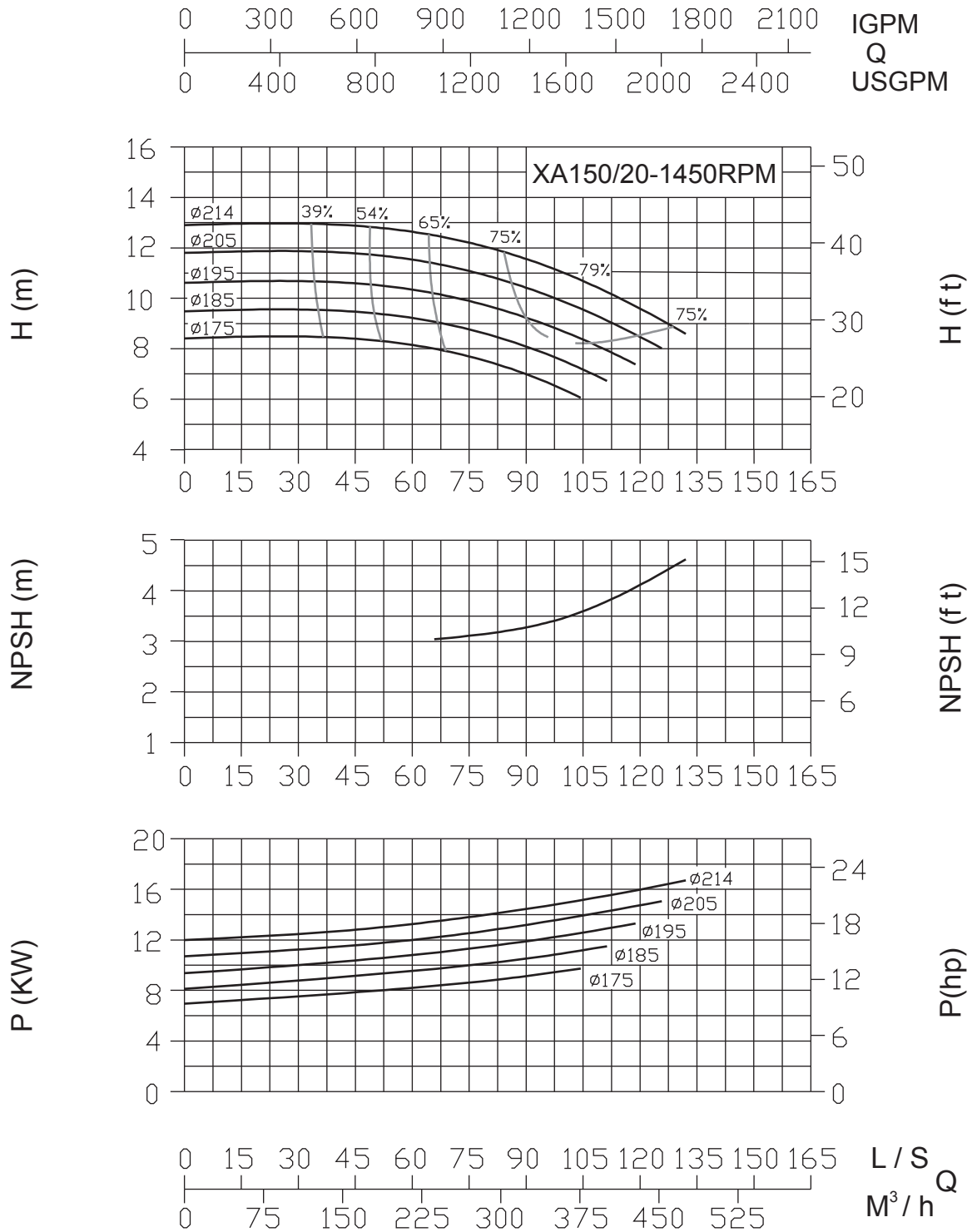



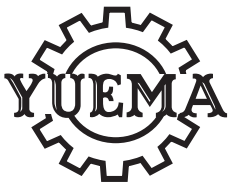

# END SUCTION PUMPS PERFORMANCE CURVES XA SERIES XA125/40-1750RPM (60HZ)

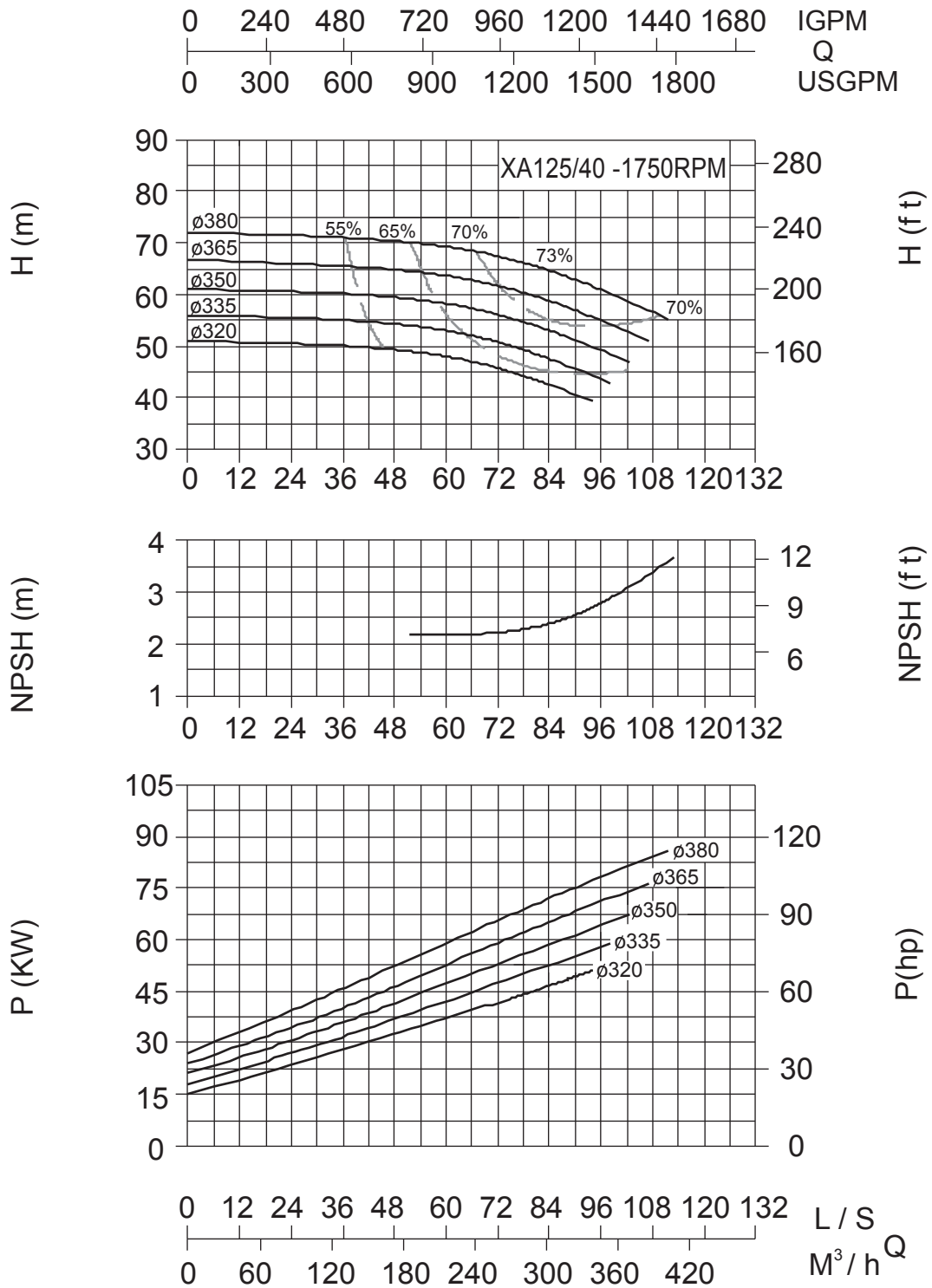

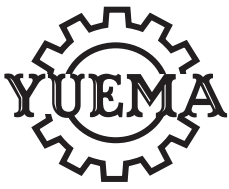

# END SUCTION PUMPS PERFORMANCE CURVES XA SERIES

## XA150/26-1450RPM (50HZ)

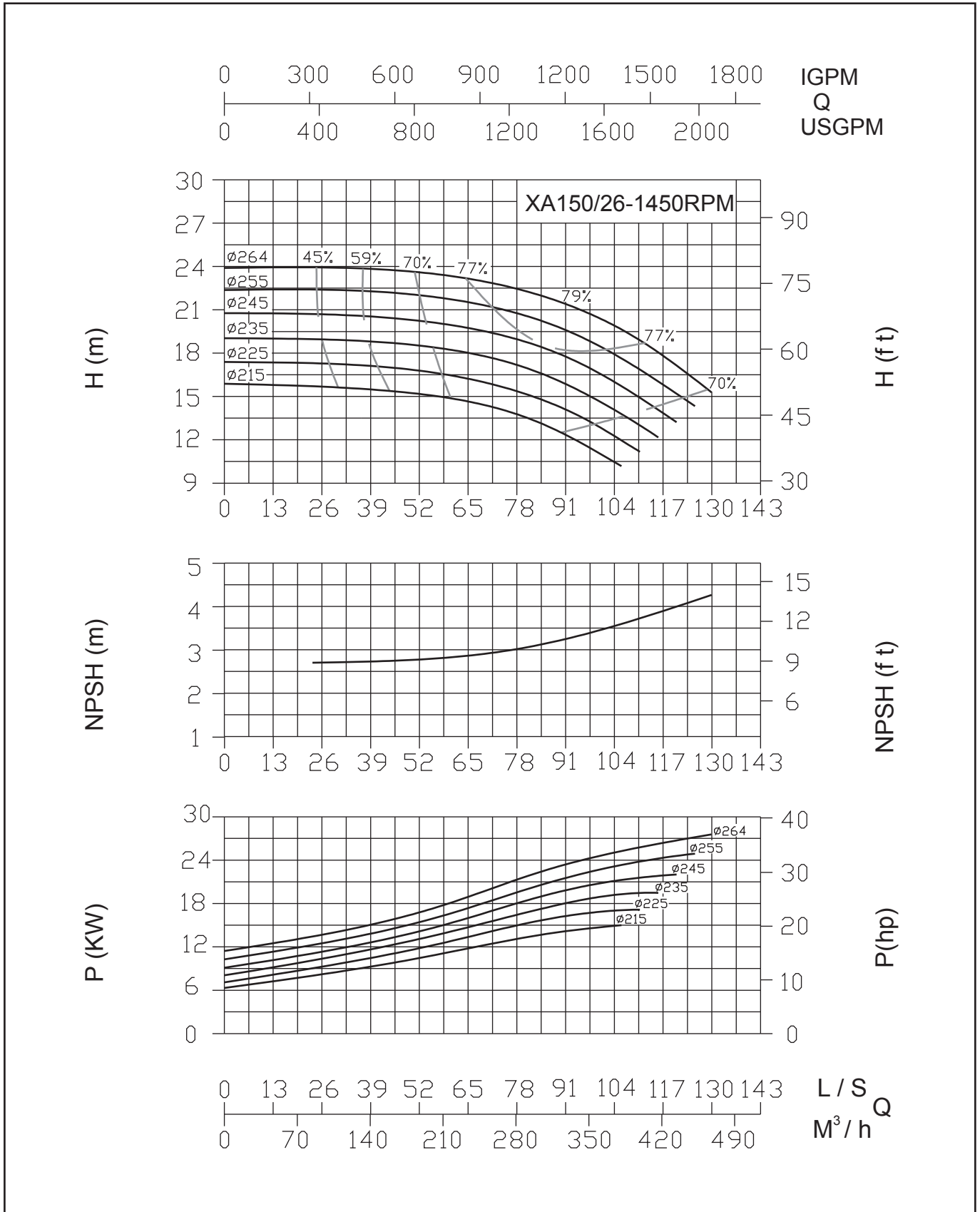

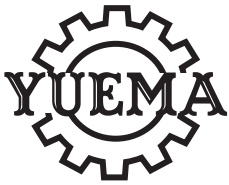

# END SUCTION PUMPS PERFORMANCE CURVES XA SERIES

## XA150/20-1750RPM (60HZ)

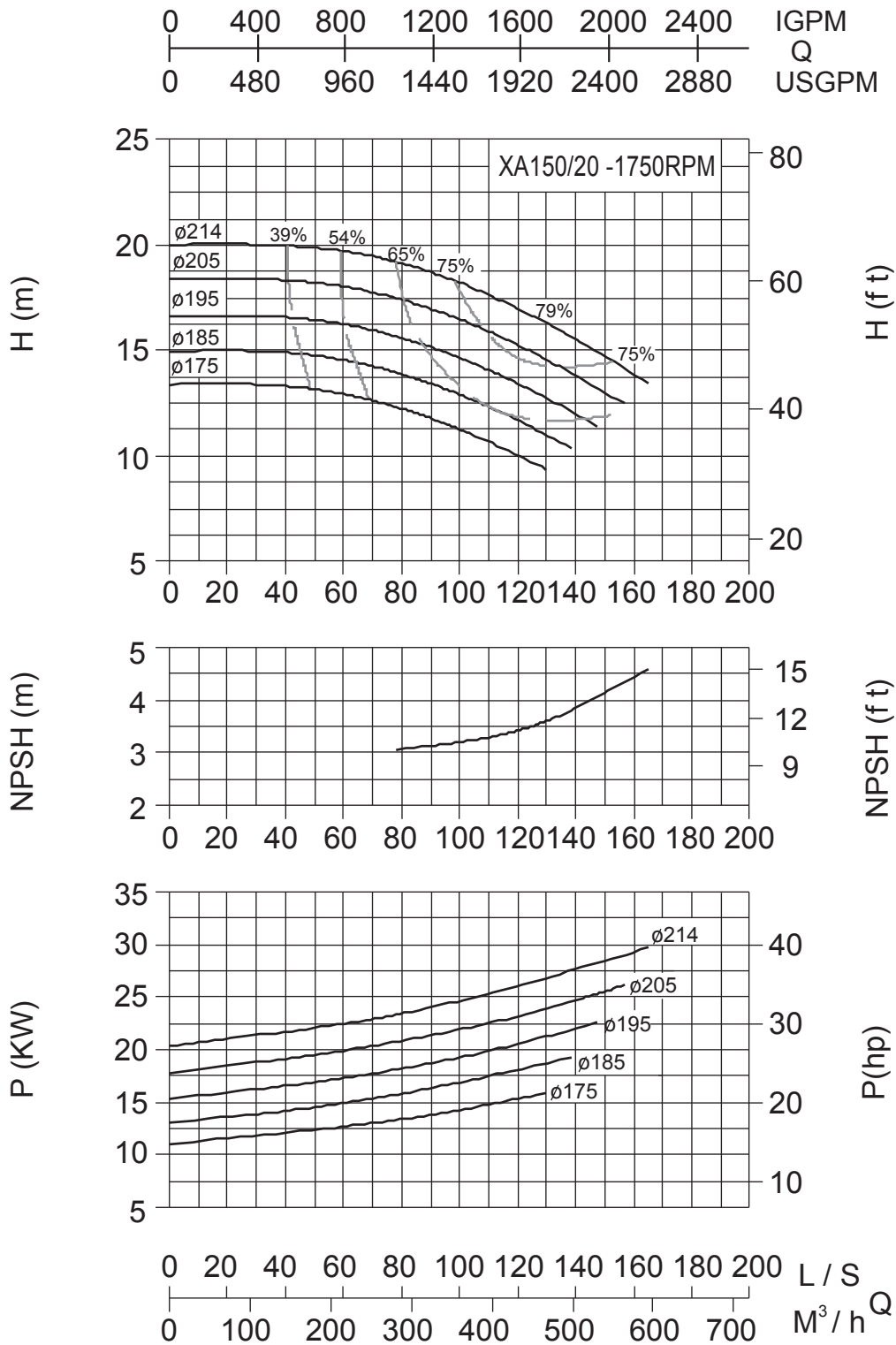



# END SUCTION PUMPS PERFORMANCE CURVES XA SERIES

## XA150/32-1450RPM (50HZ)

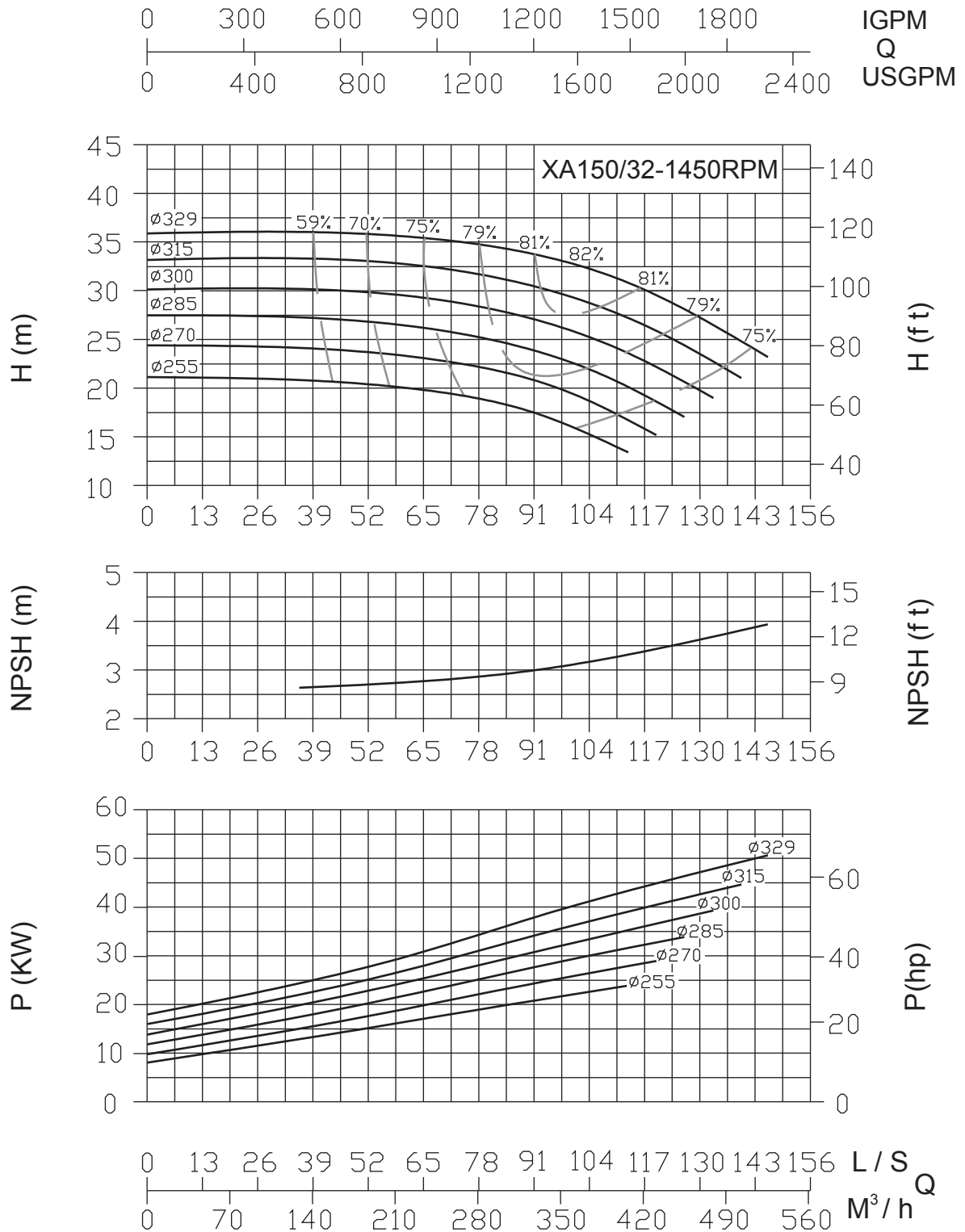

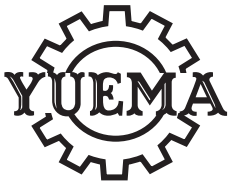

# END SUCTION PUMPS PERFORMANCE CURVES XA SERIES

## XA150/26-1750RPM (60HZ)

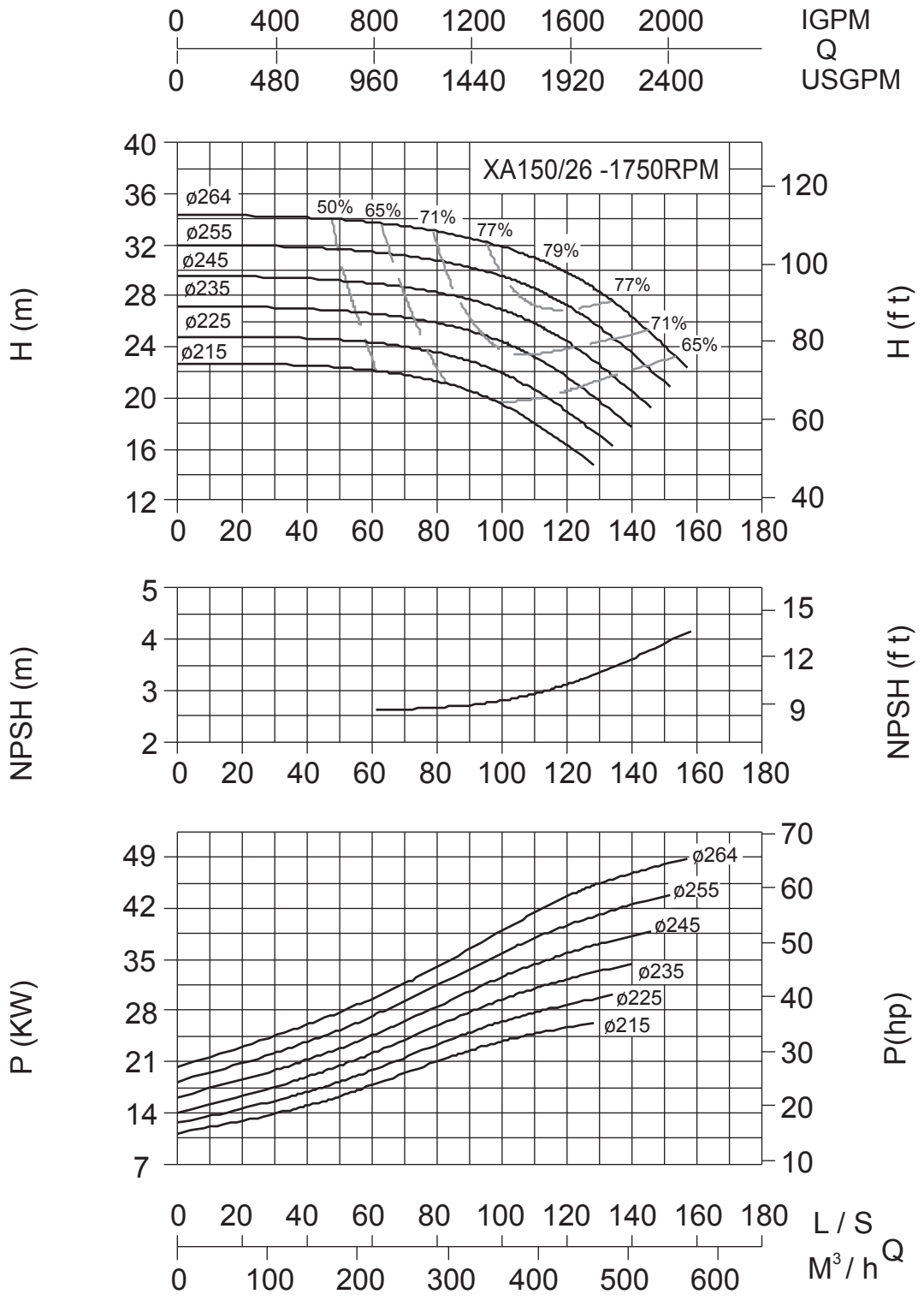



# END SUCTION PUMPS PERFORMANCE CURVES XA SERIES

## XA150/40-1450RPM (50HZ)

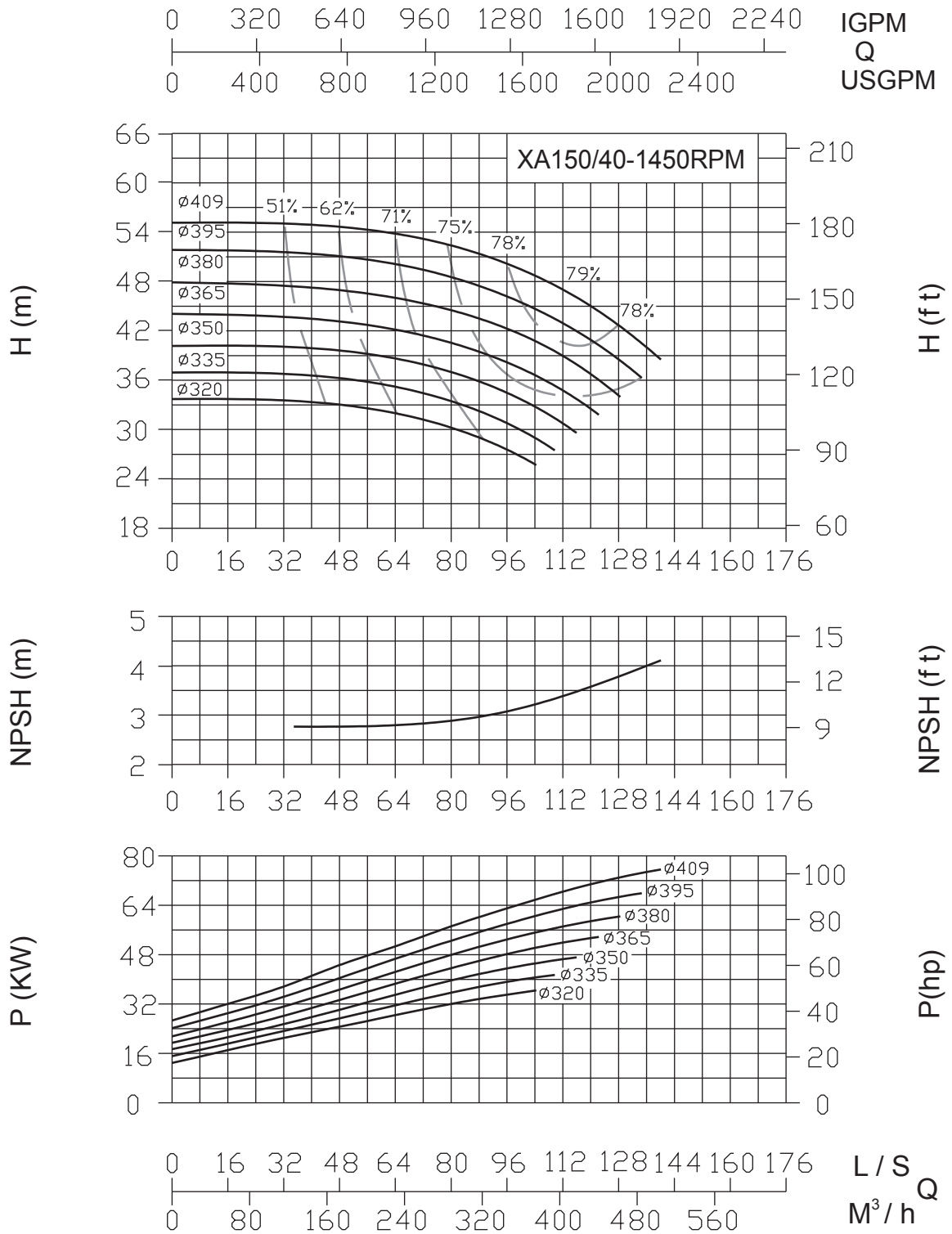

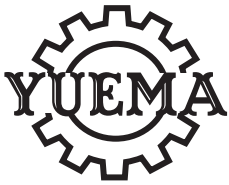

# END SUCTION PUMPS PERFORMANCE CURVES XA SERIES

## XA150/32-1750RPM (60HZ)

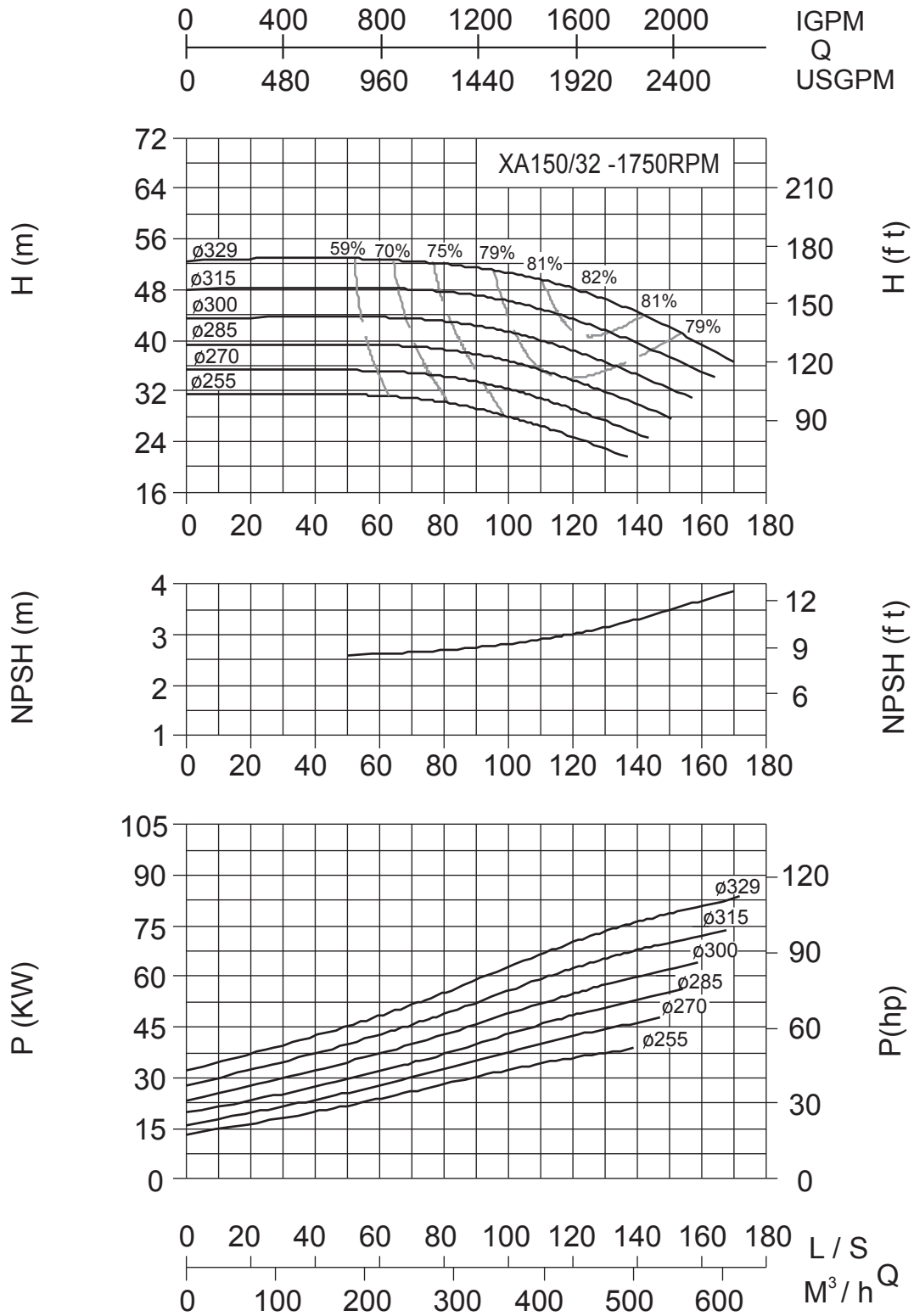



# END SUCTION PUMPS PERFORMANCE CURVES XA SERIES

## XA200/26-1450RPM (50HZ)

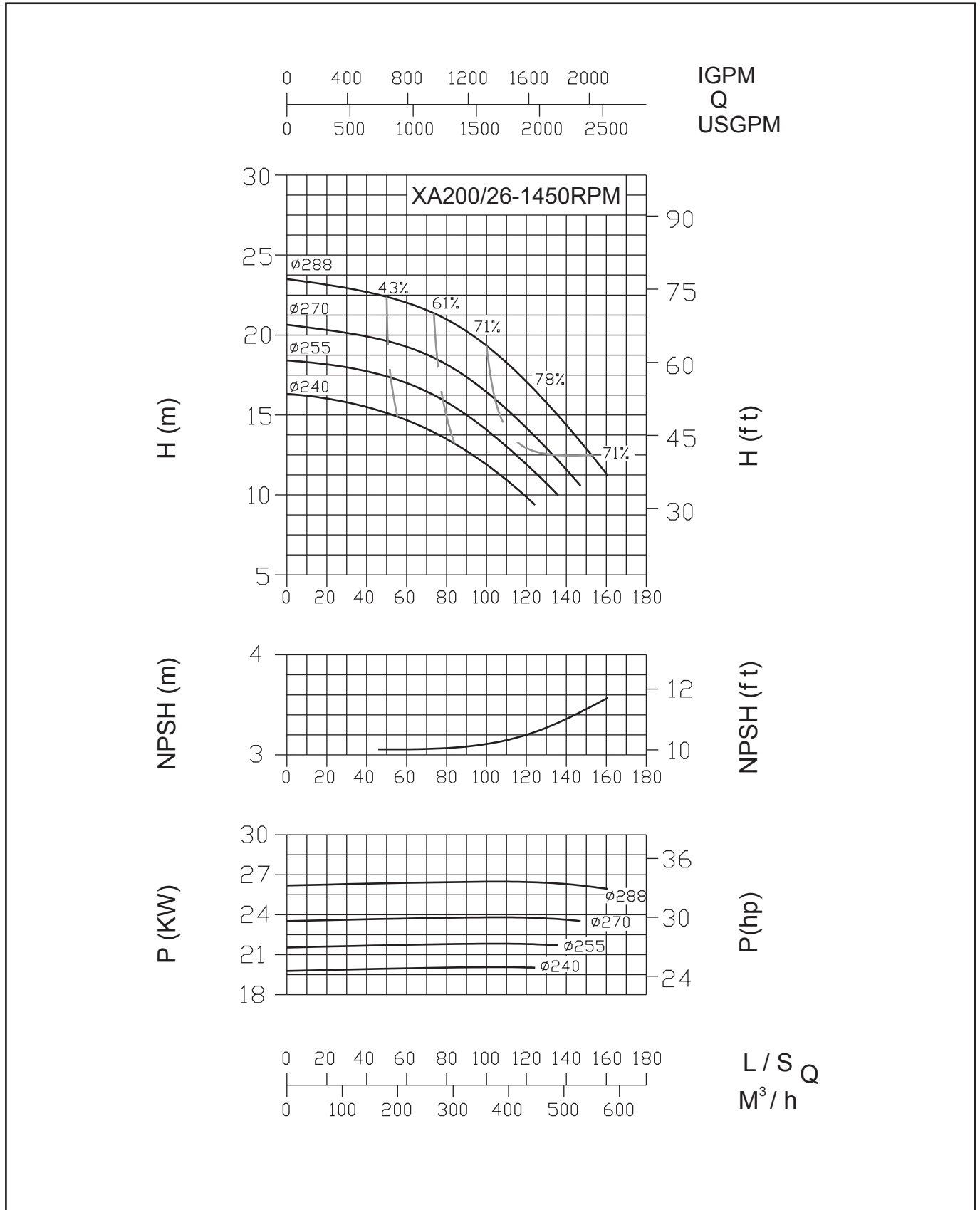





# END SUCTION PUMPS PERFORMANCE CURVES XA SERIES

## XA150/40-1750RPM (60HZ)

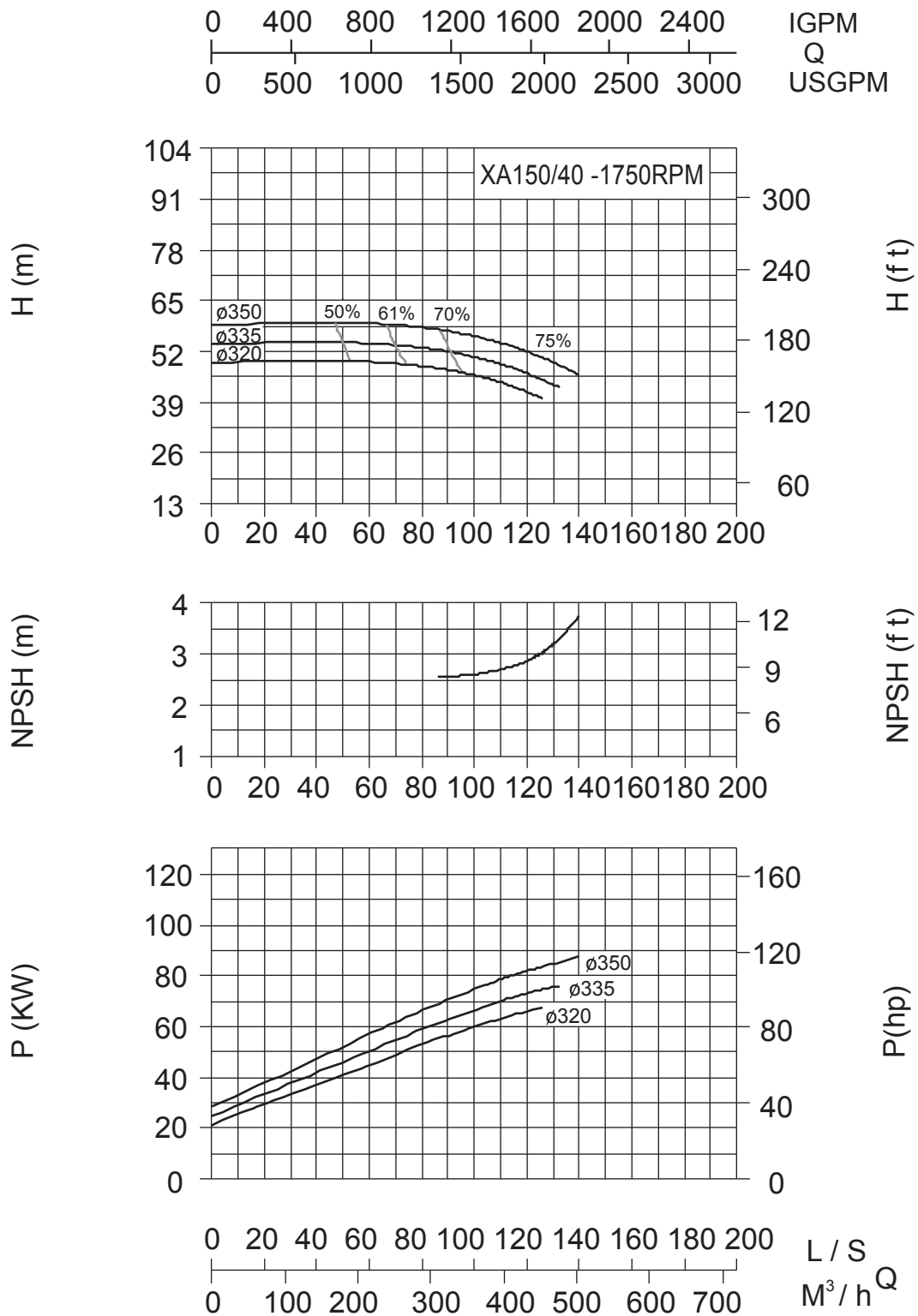



# END SUCTION PUMPS PERFORMANCE CURVES XA SERIES

## XA200/32-1450RPM (50HZ)

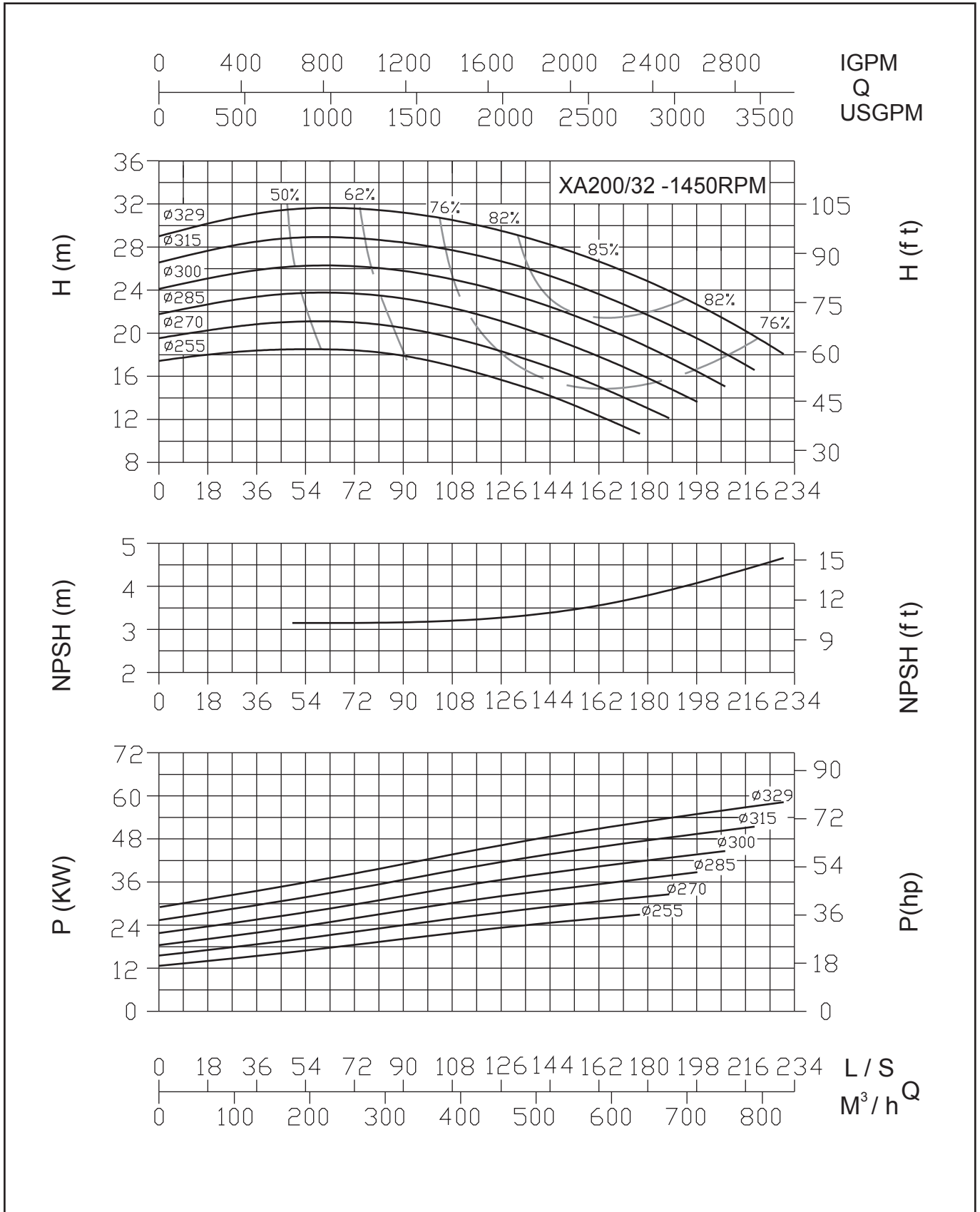



# END SUCTION PUMPS PERFORMANCE CURVES XA SERIES

## XA200/26-1750RPM (60HZ)

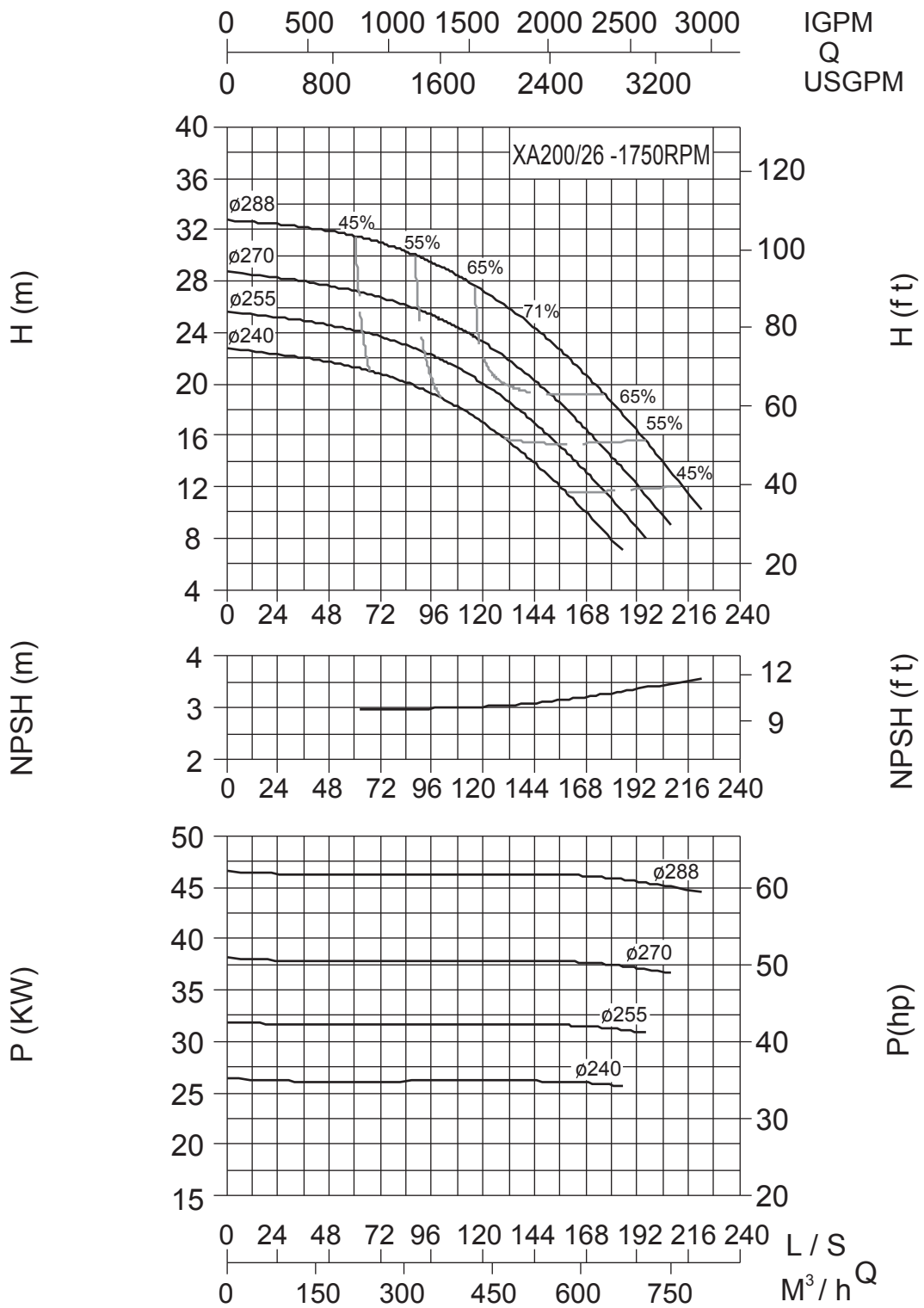

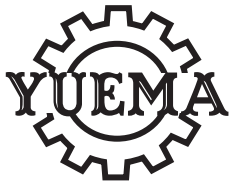

# END SUCTION PUMPS PERFORMANCE CURVES XA SERIES

## XA200/40-1450RPM (50HZ)

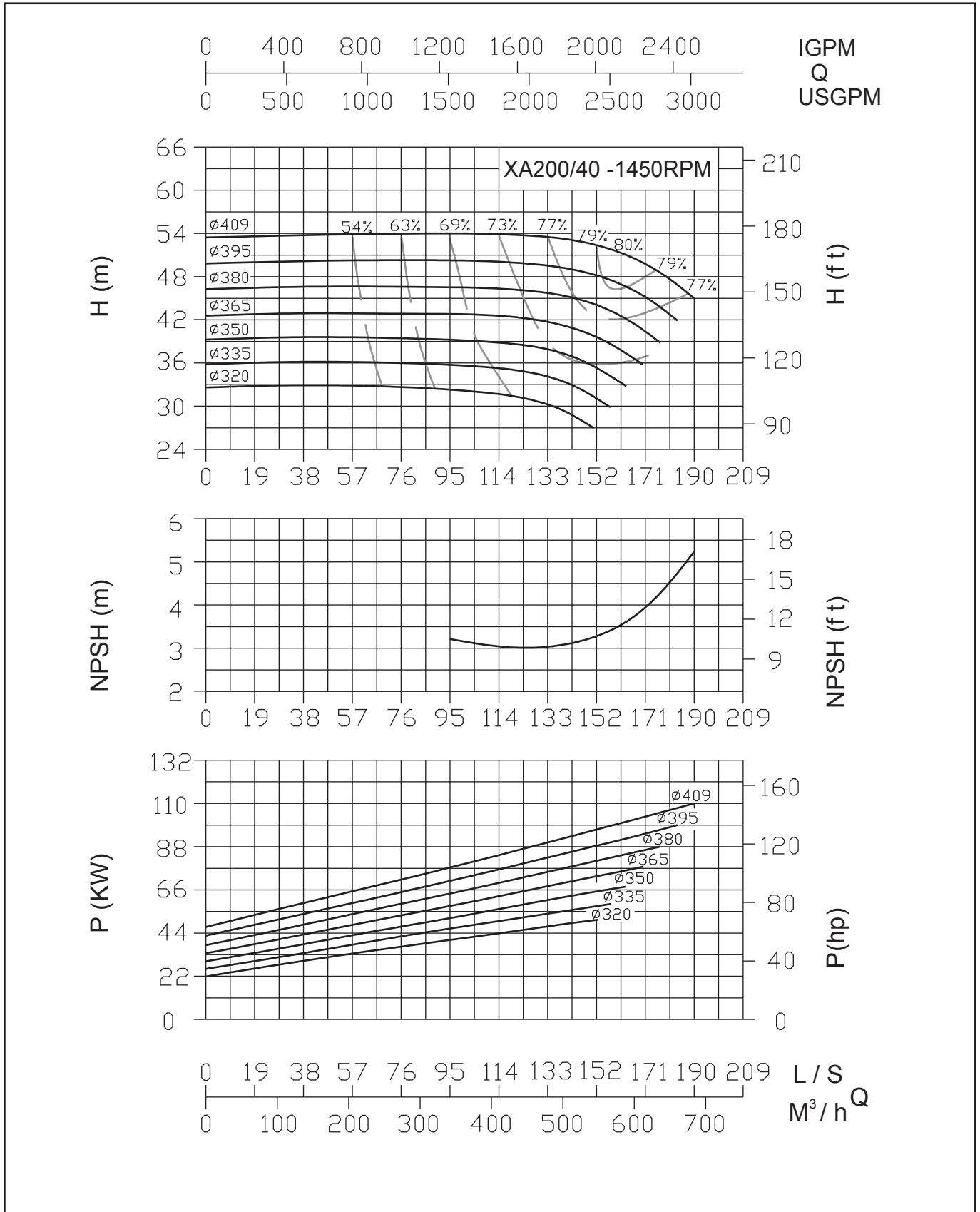

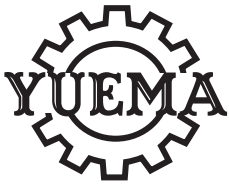

# END SUCTION PUMPS PERFORMANCE CURVES XA SERIES

## XA200/32-1750RPM (60HZ)

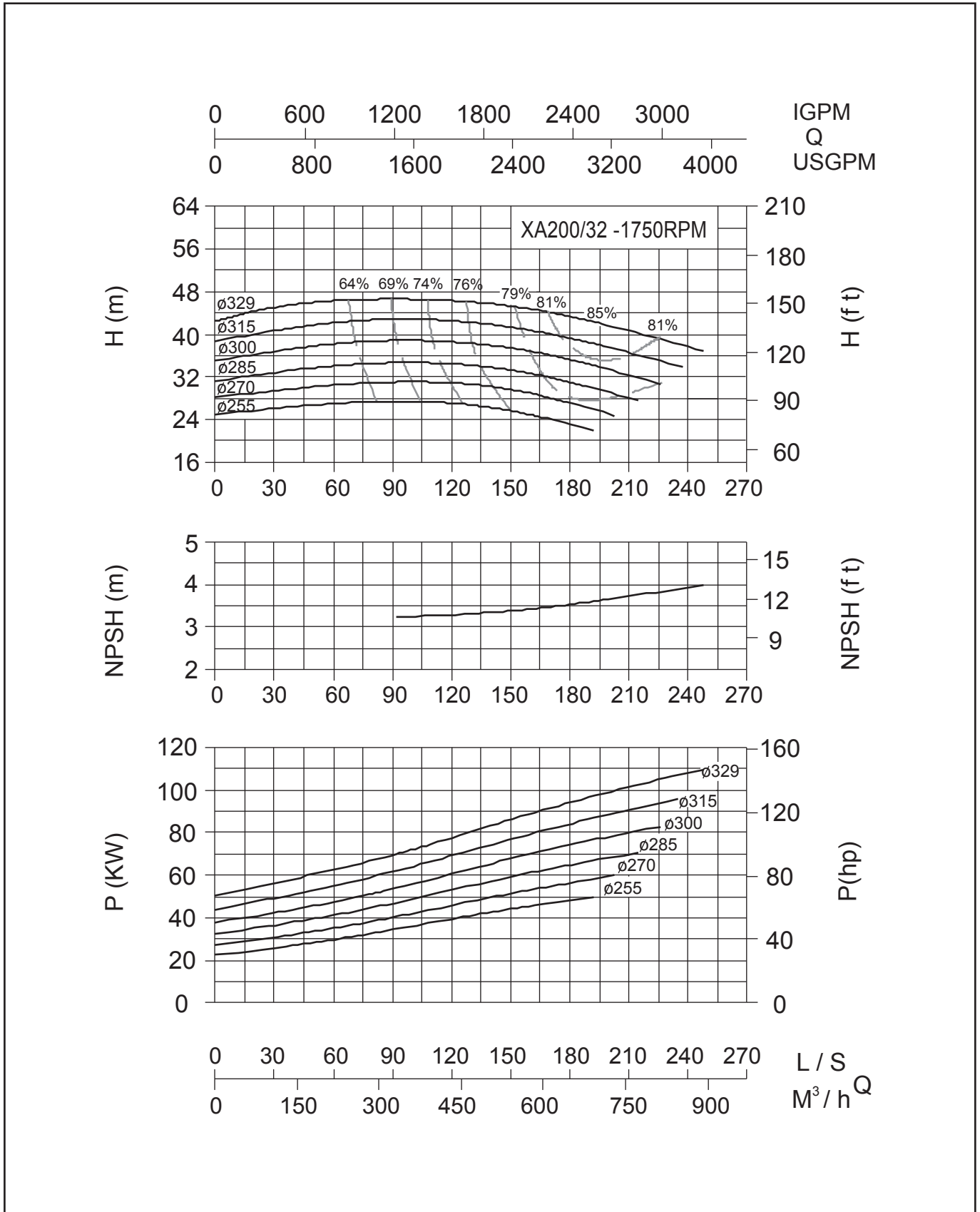

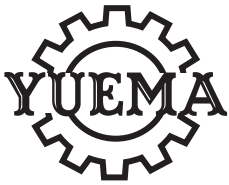

# END SUCTION PUMPS PERFORMANCE CURVES XA SERIES

## XA250/32-1450RPM (50HZ)

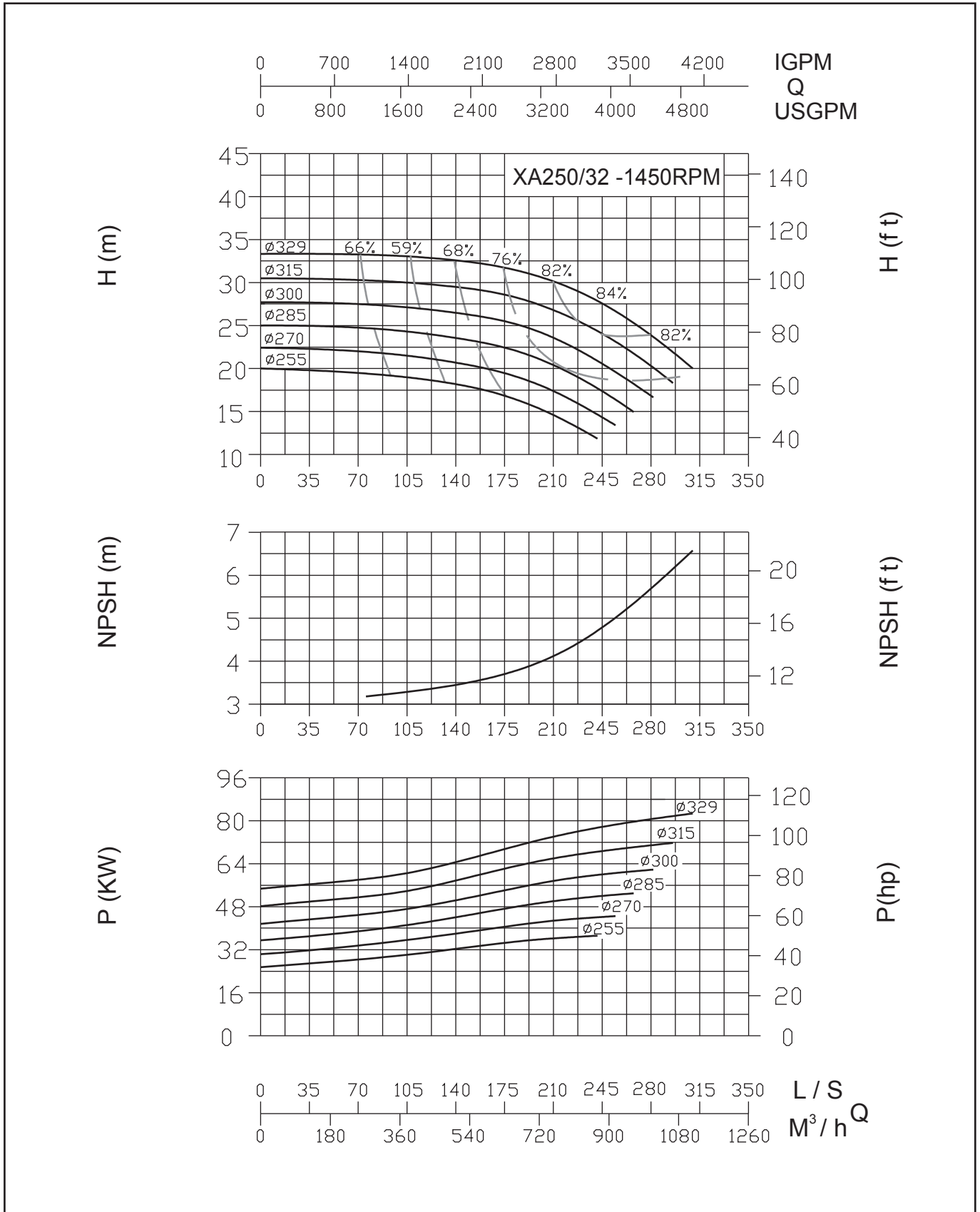

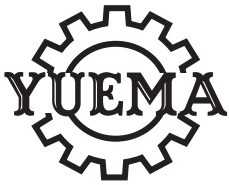

# END SUCTION PUMPS PERFORMANCE CURVES XA SERIES

## XA200/40-1750RPM (60HZ)

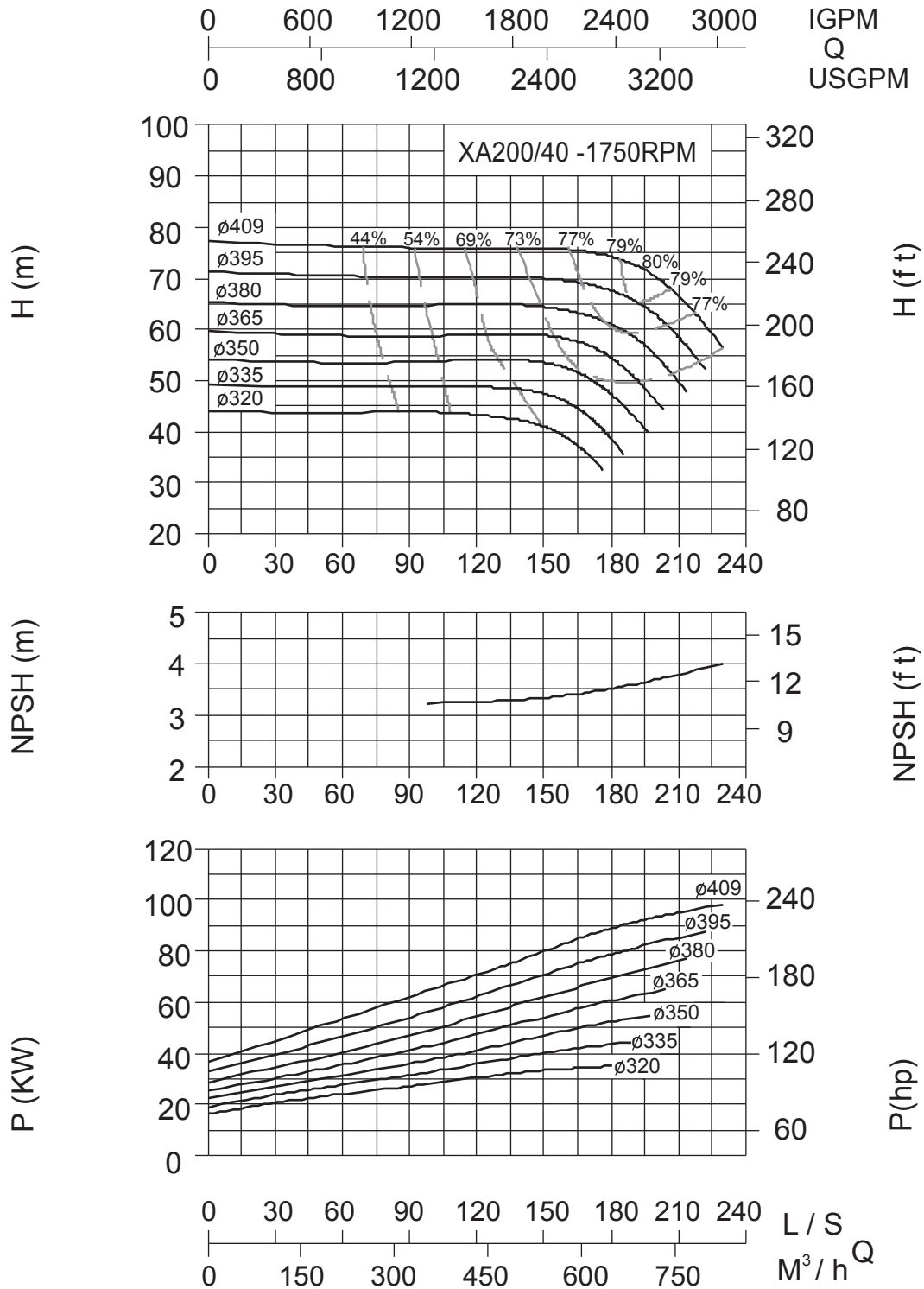

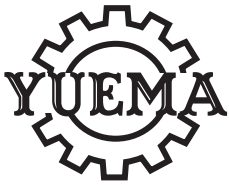

# END SUCTION PUMPS PERFORMANCE CURVES XA SERIES

## XA250/40-1450RPM (50HZ)

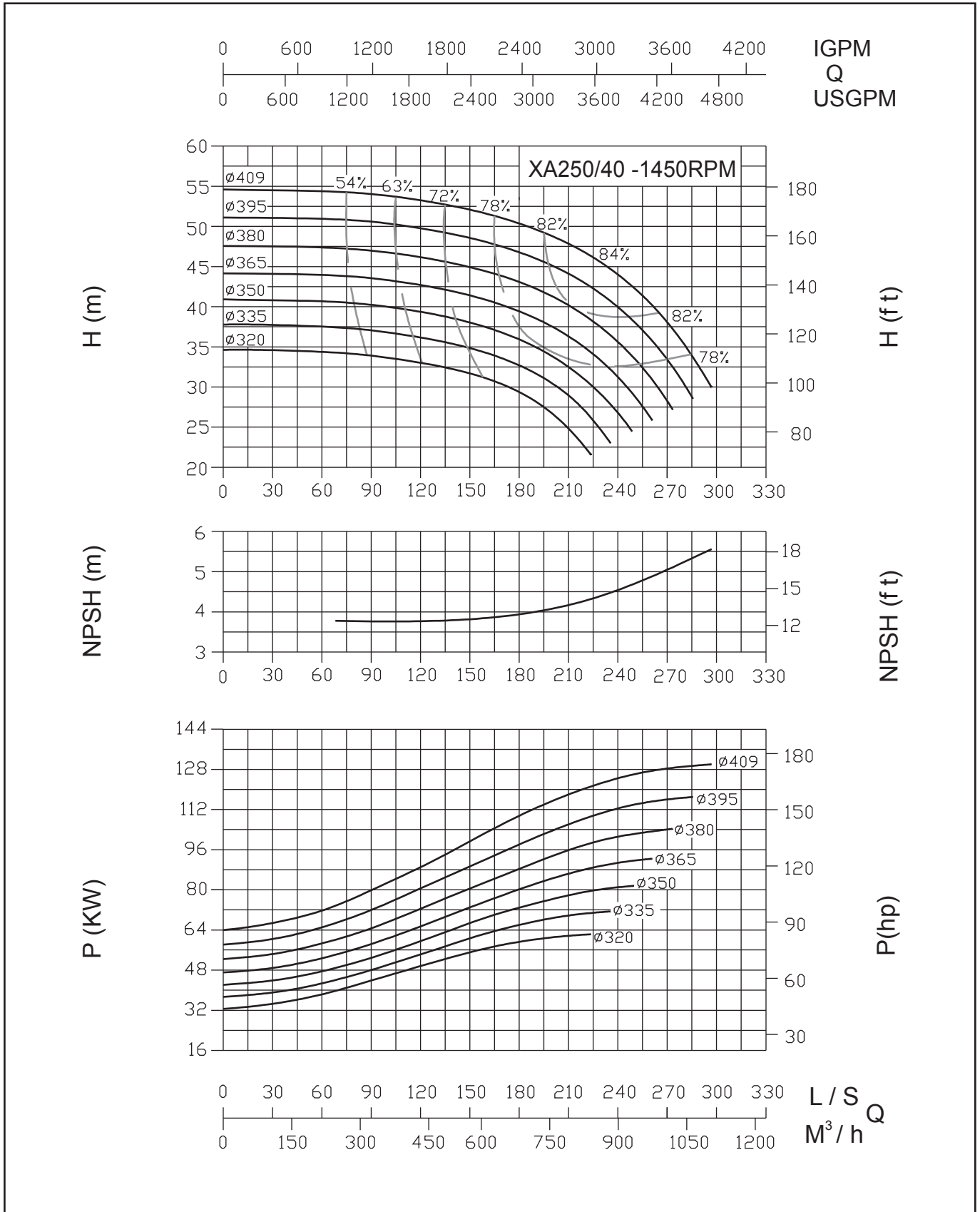



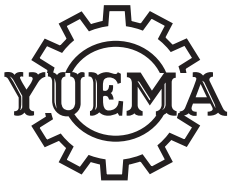

# END SUCTION PUMPS PERFORMANCE CURVES XA SERIES

## XA250/32-1750RPM (60HZ)

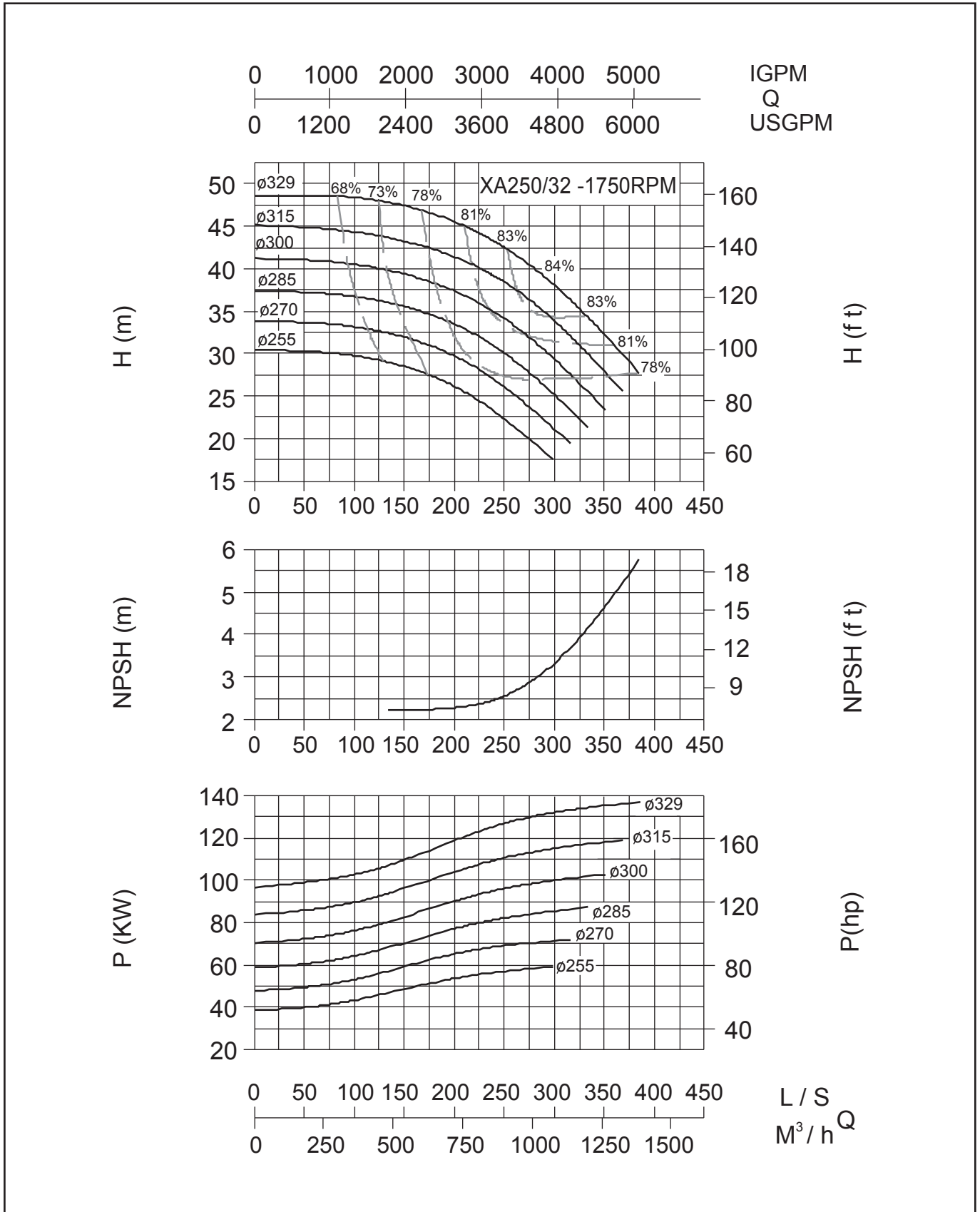



# END SUCTION PUMPS PERFORMANCE CURVES XA SERIES

## XA 125/50-1450RPM (50HZ)

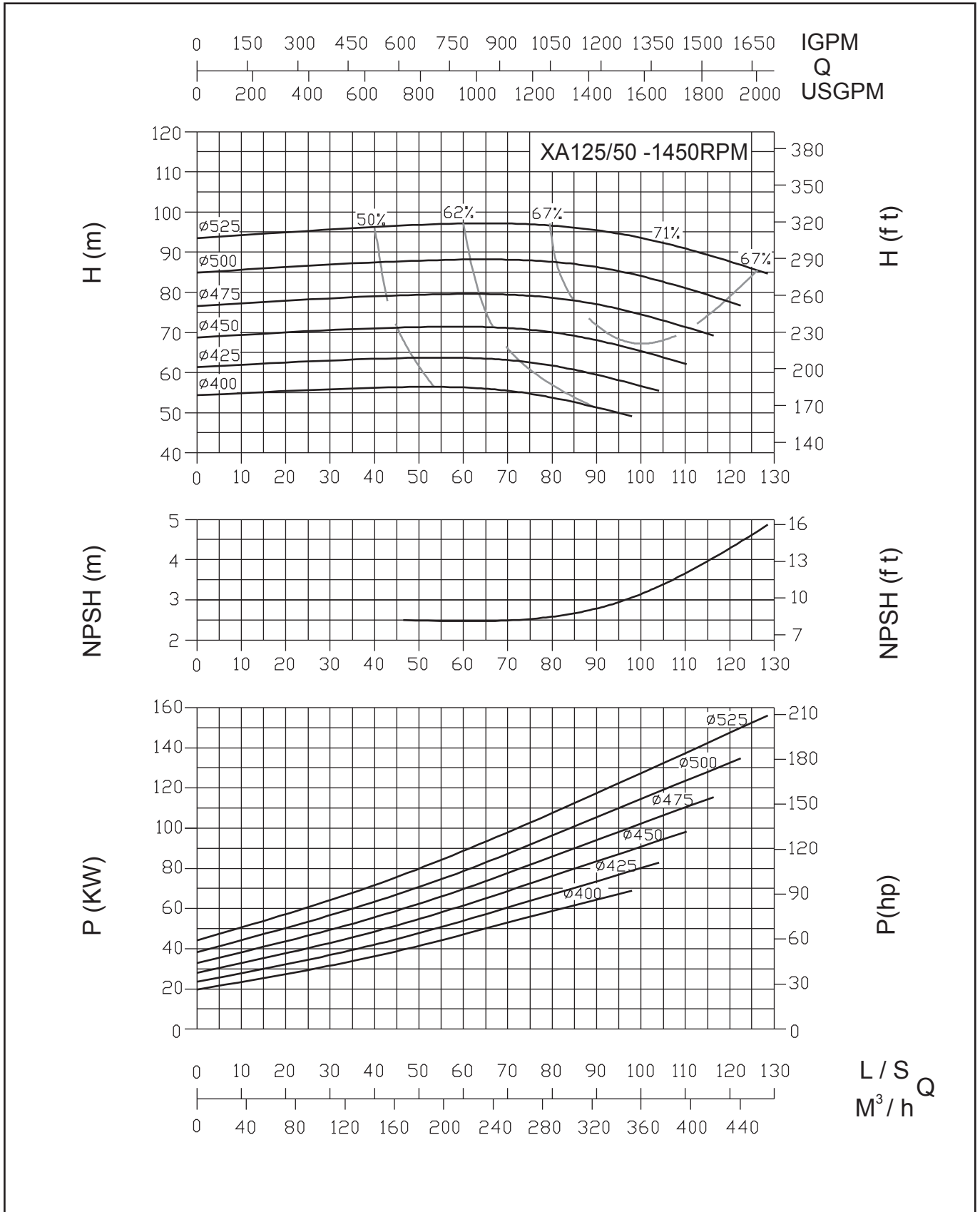



# END SUCTION PUMPS PERFORMANCE CURVES XA SERIES

## XA250/40-1750RPM (60HZ)

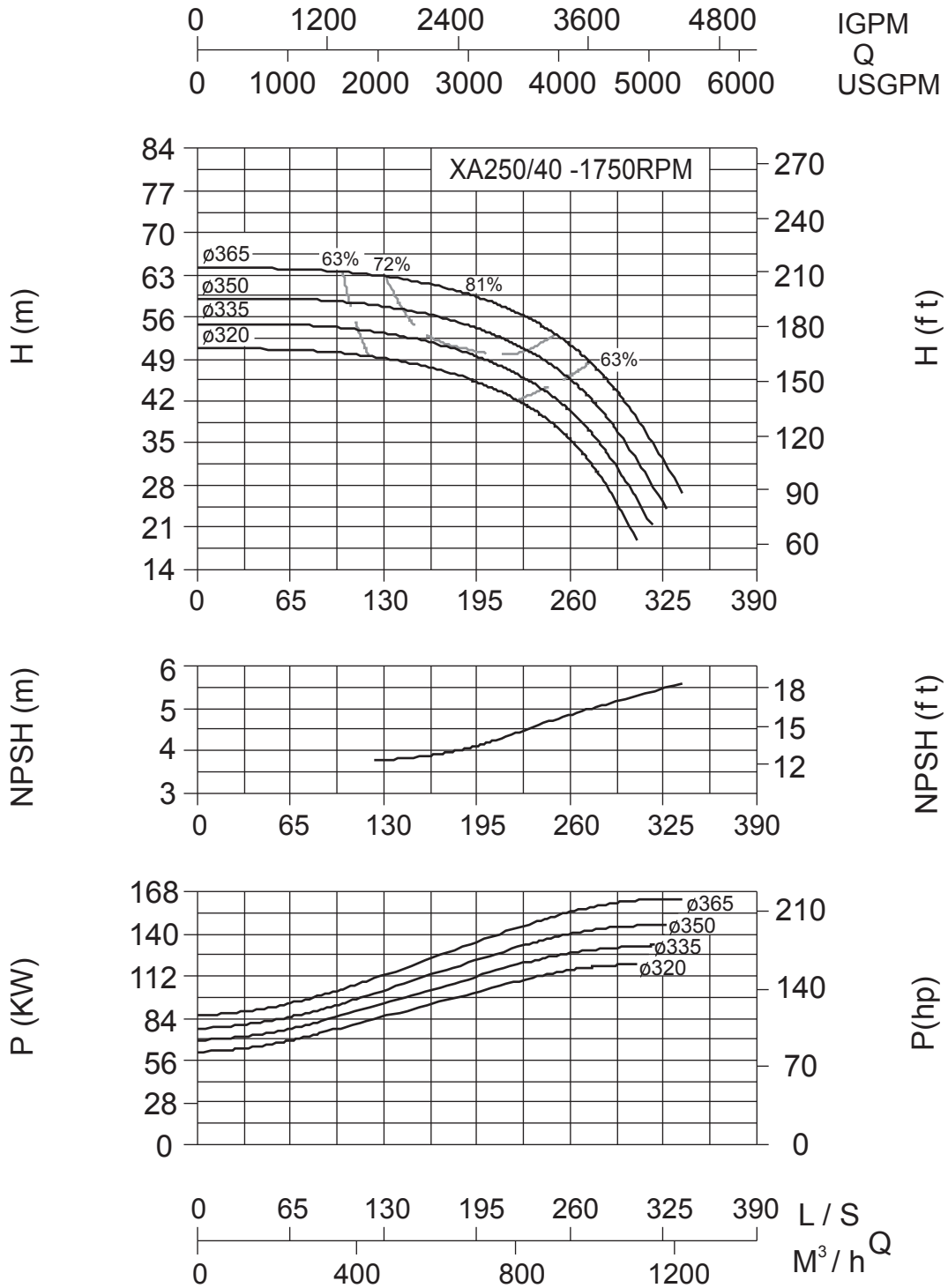

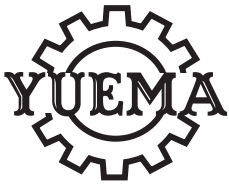

# END SUCTION PUMPS PERFORMANCE CURVES XA SERIES

## XA150/50-1450RPM (50HZ)

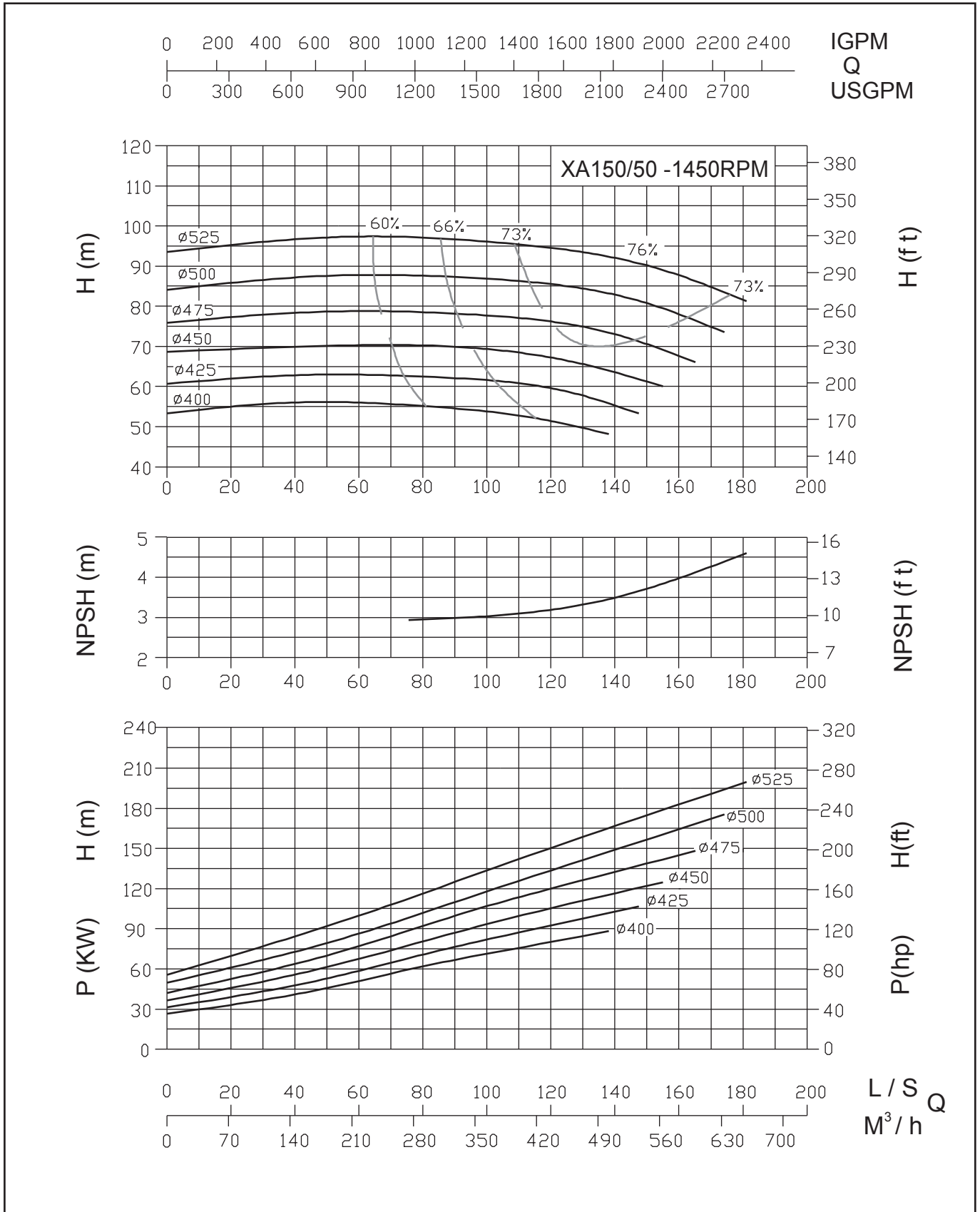



# END SUCTION PUMPS PERFORMANCE CURVES XA SERIES

## XA32/13-3500RPM (60HZ)

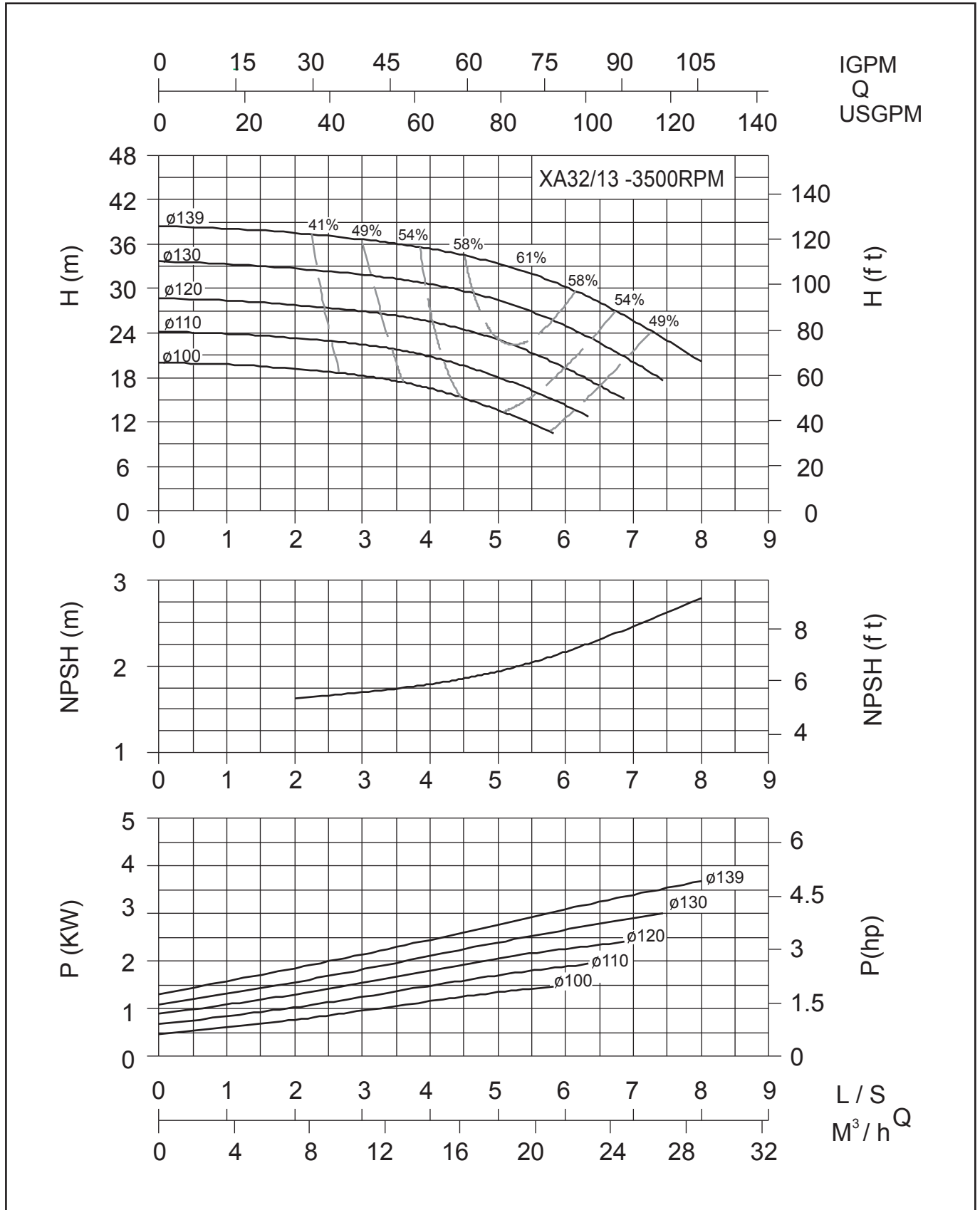

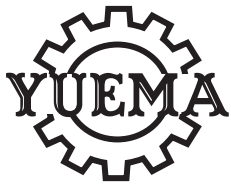

# END SUCTION PUMPS PERFORMANCE CURVES XA SERIES

## XA80/32N-1450RPM (50HZ)

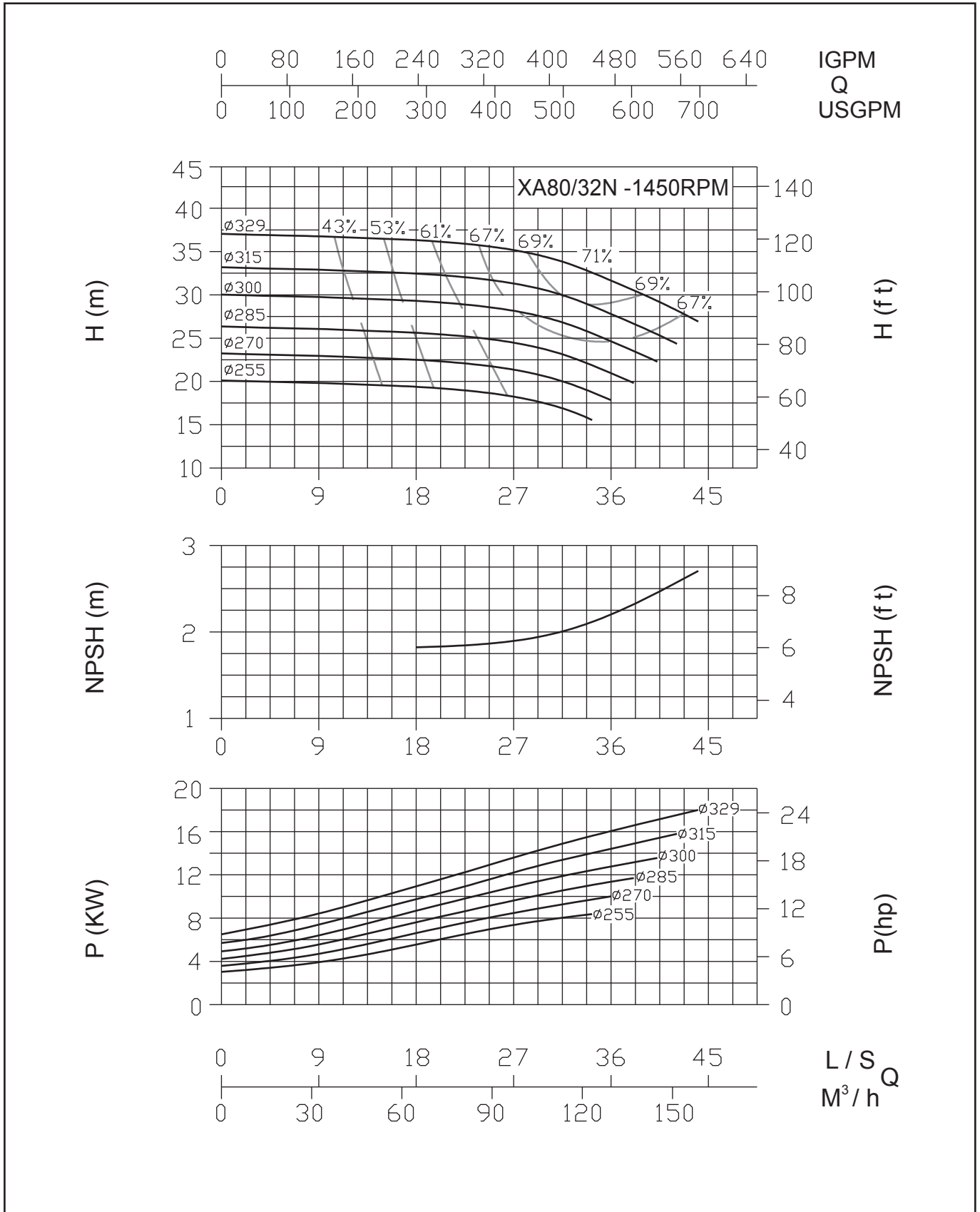

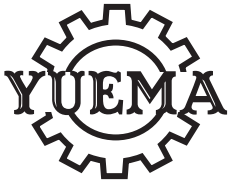

# END SUCTION PUMPS PERFORMANCE CURVES XA SERIES

## XA32/16-3500RPM (60HZ)

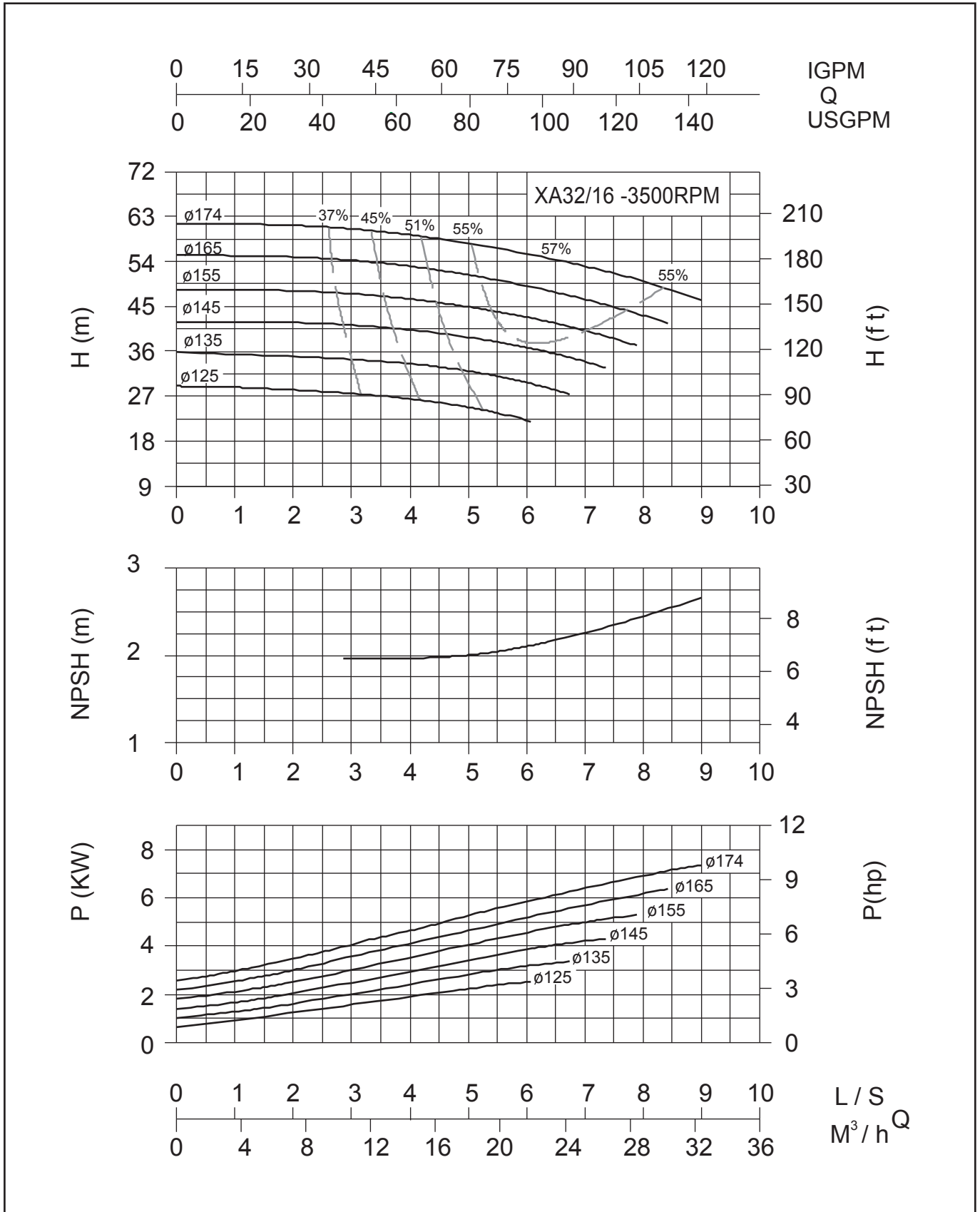

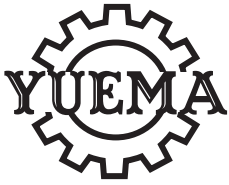

# END SUCTION PUMPS PERFORMANCE CURVES XA SERIES

## XA32/13-2900RPM (50HZ)

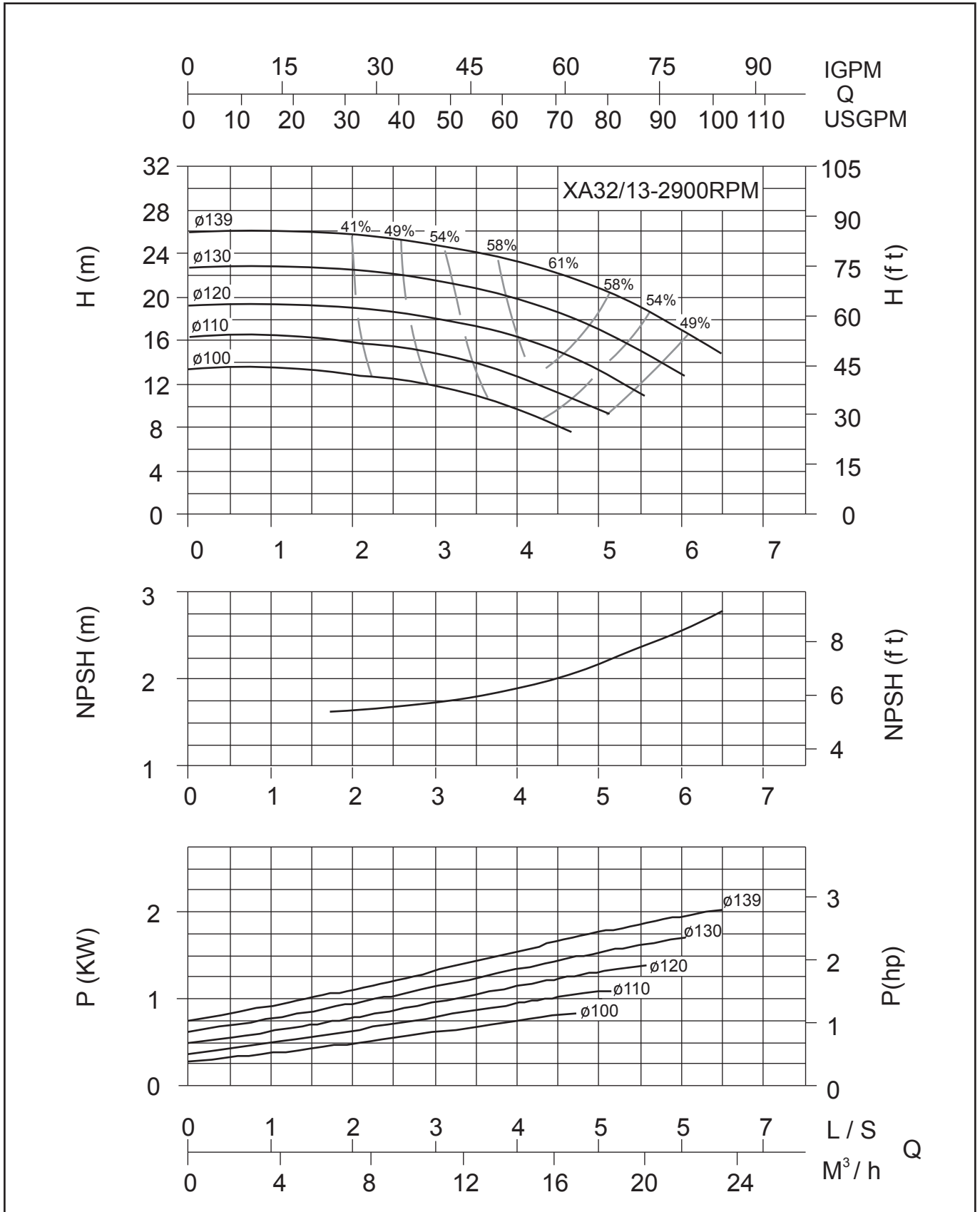



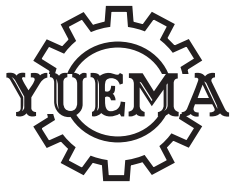

# END SUCTION PUMPS PERFORMANCE CURVES XA SERIES

## XA32/20-3500RPM (60HZ)

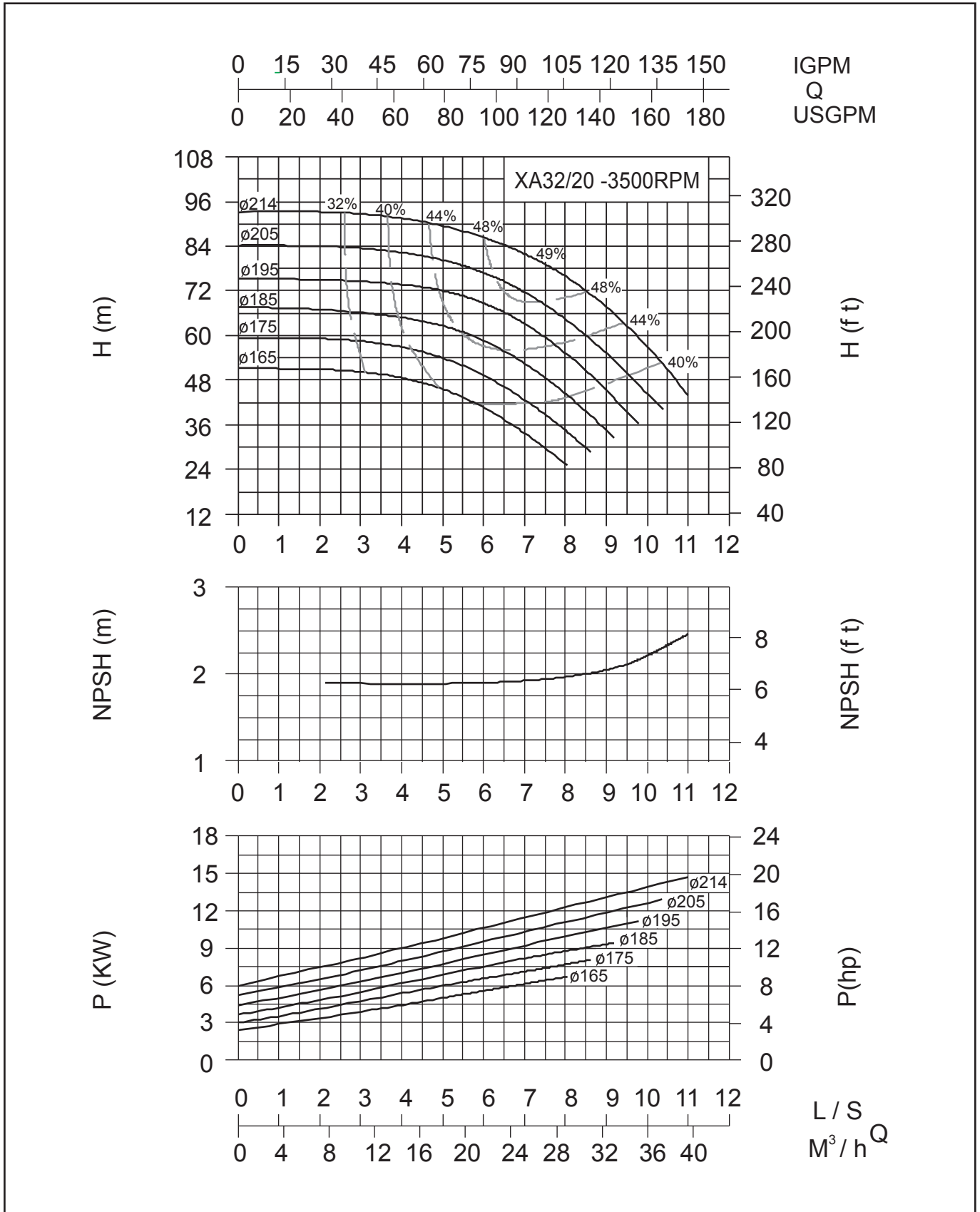



# END SUCTION PUMPS PERFORMANCE CURVES XA SERIES

## XA 32/16-2900RPM (50HZ)

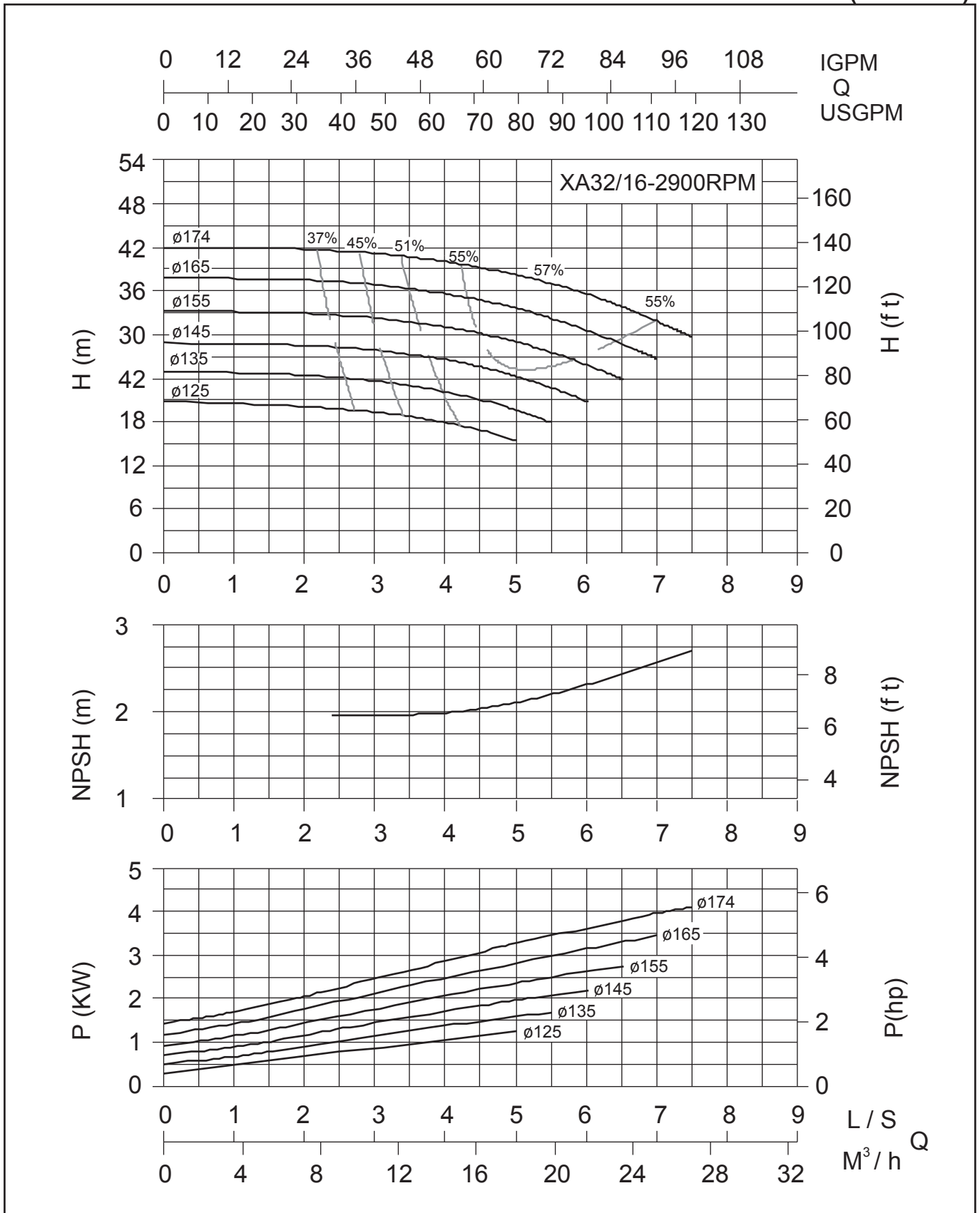

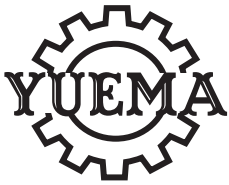

# END SUCTION PUMPS PERFORMANCE CURVES XA SERIES

## XA32/26-3500RPM (60HZ)

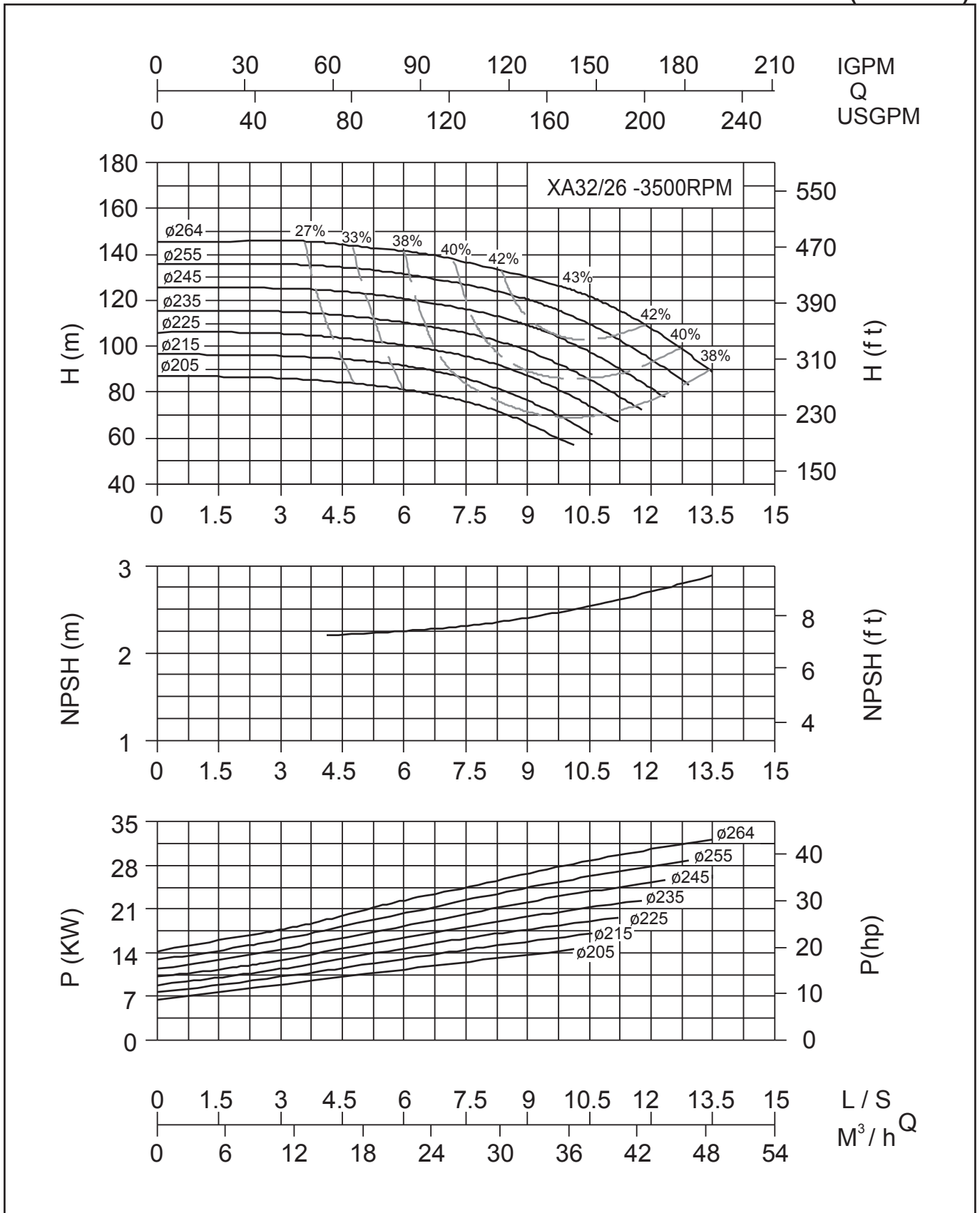



# END SUCTION PUMPS PERFORMANCE CURVES XA SERIES

## XA32/20-2900RPM (50HZ)

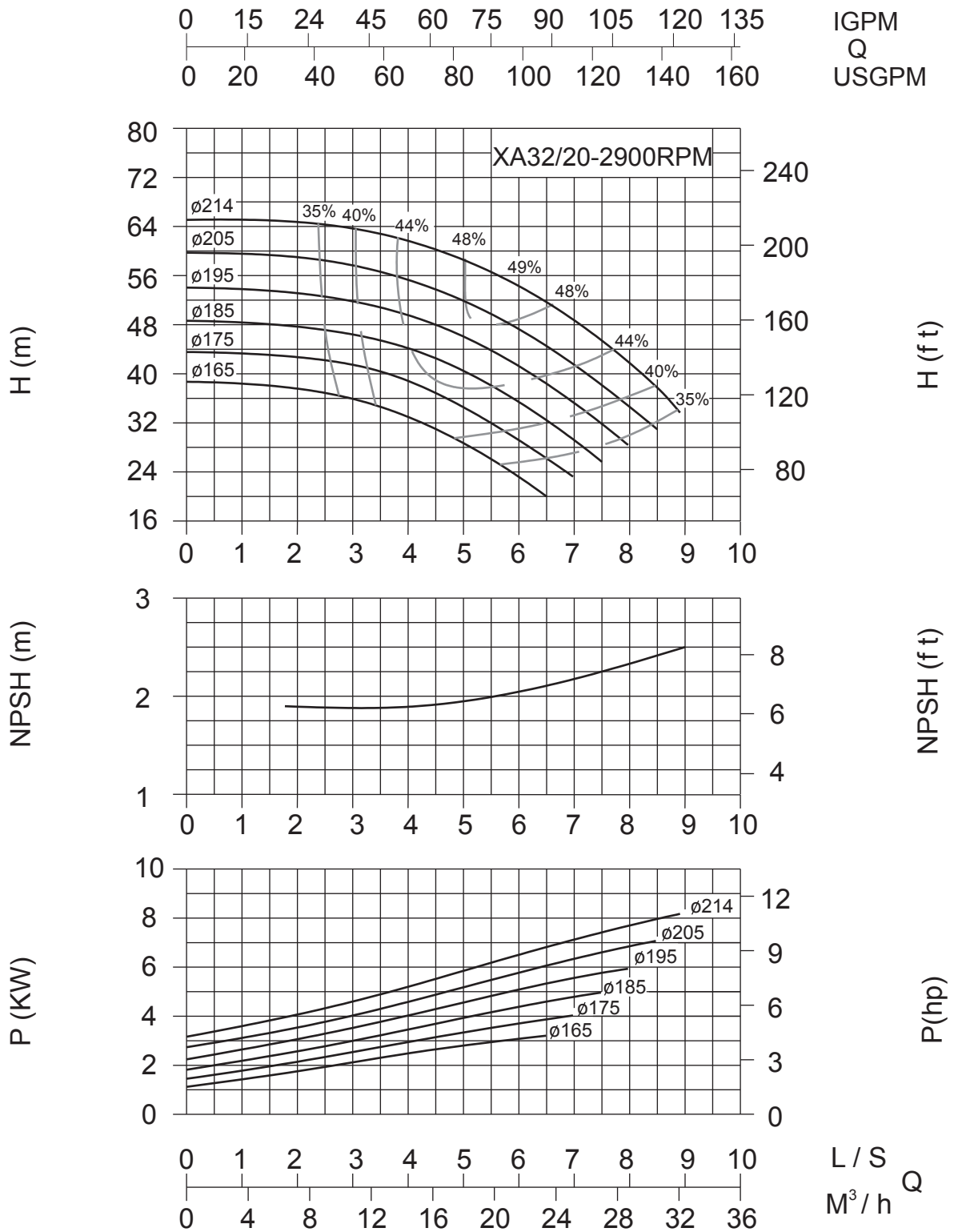



# END SUCTION PUMPS PERFORMANCE CURVES XA SERIES

## XA40/13-3500 (60HZ)

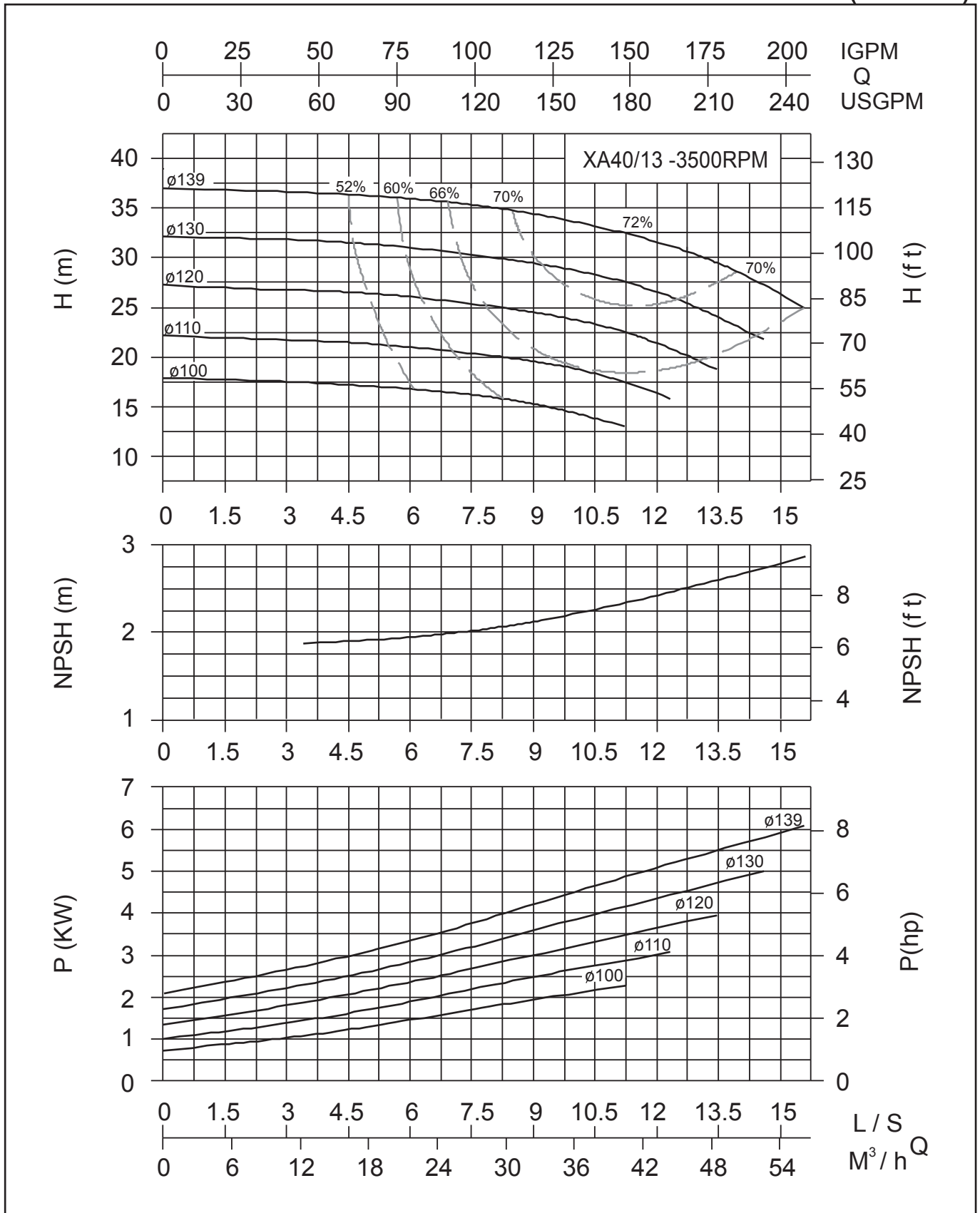



# END SUCTION PUMPS PERFORMANCE CURVES XA SERIES

## XA32/26-2900RPM (50HZ)

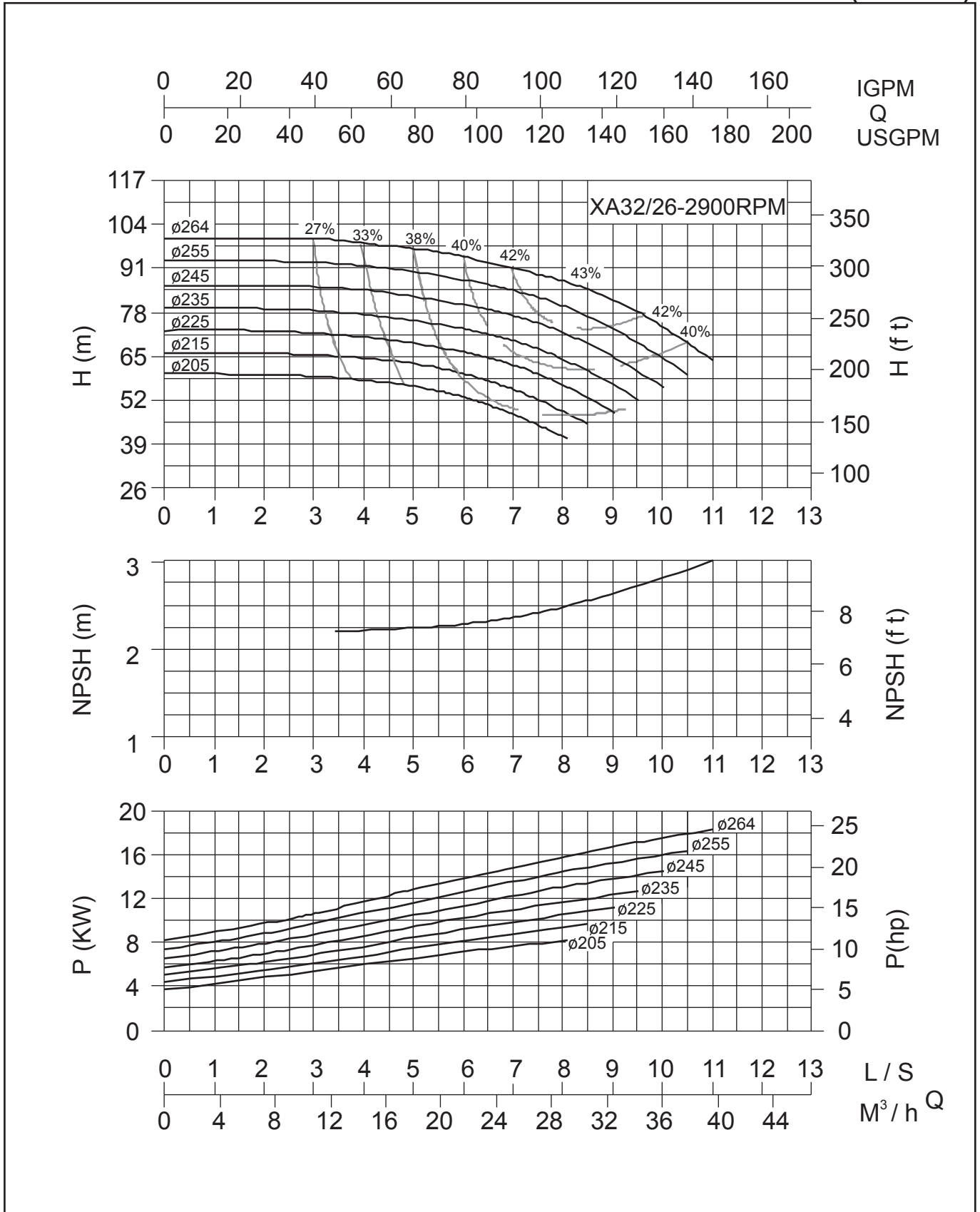

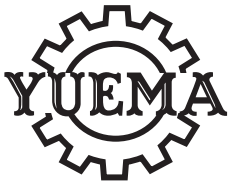

# END SUCTION PUMPS PERFORMANCE CURVES XA SERIES

## XA40/16-3500RPM (60HZ)

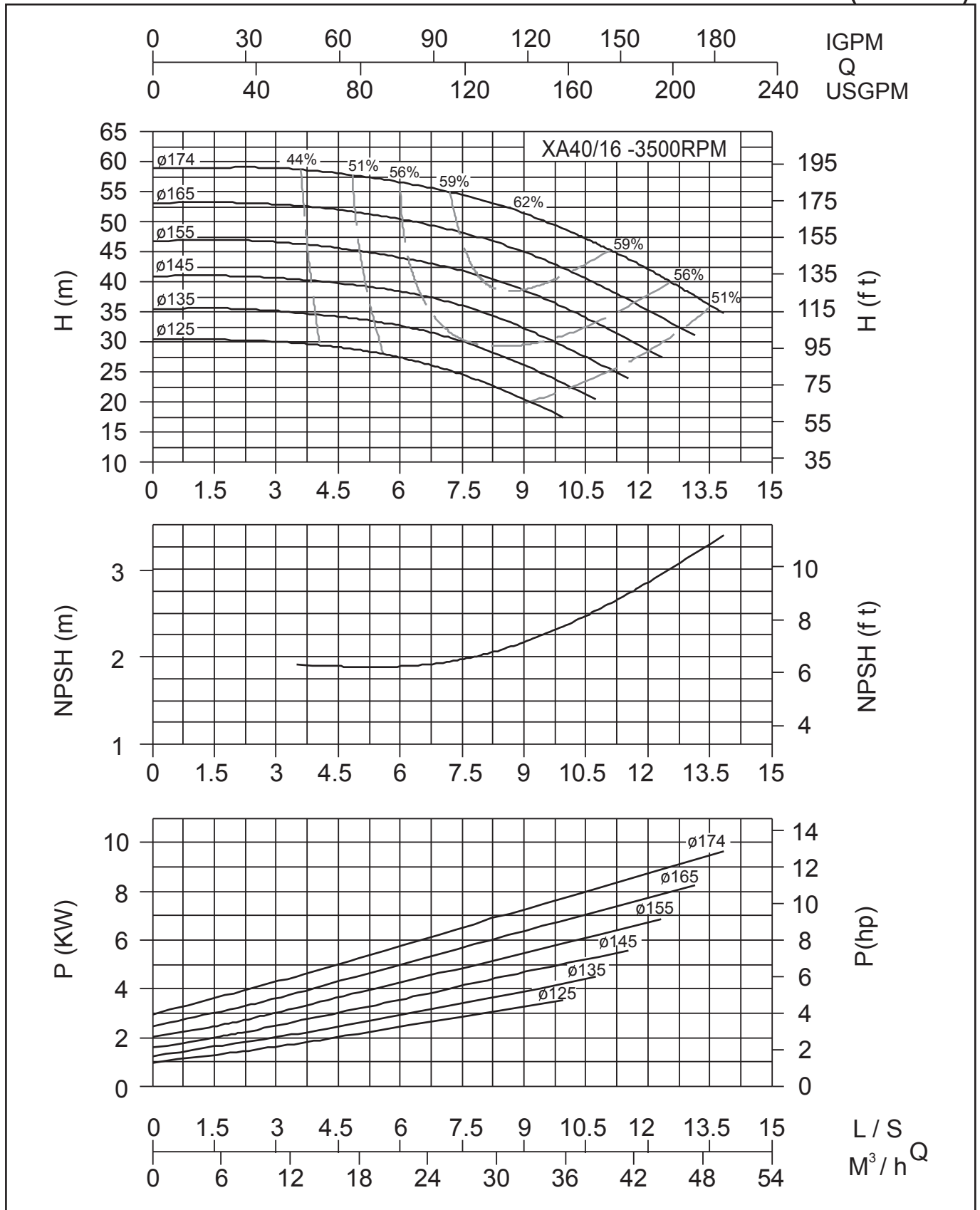



# END SUCTION PUMPS PERFORMANCE CURVES XA SERIES

## XA40/13-2900 (50HZ)

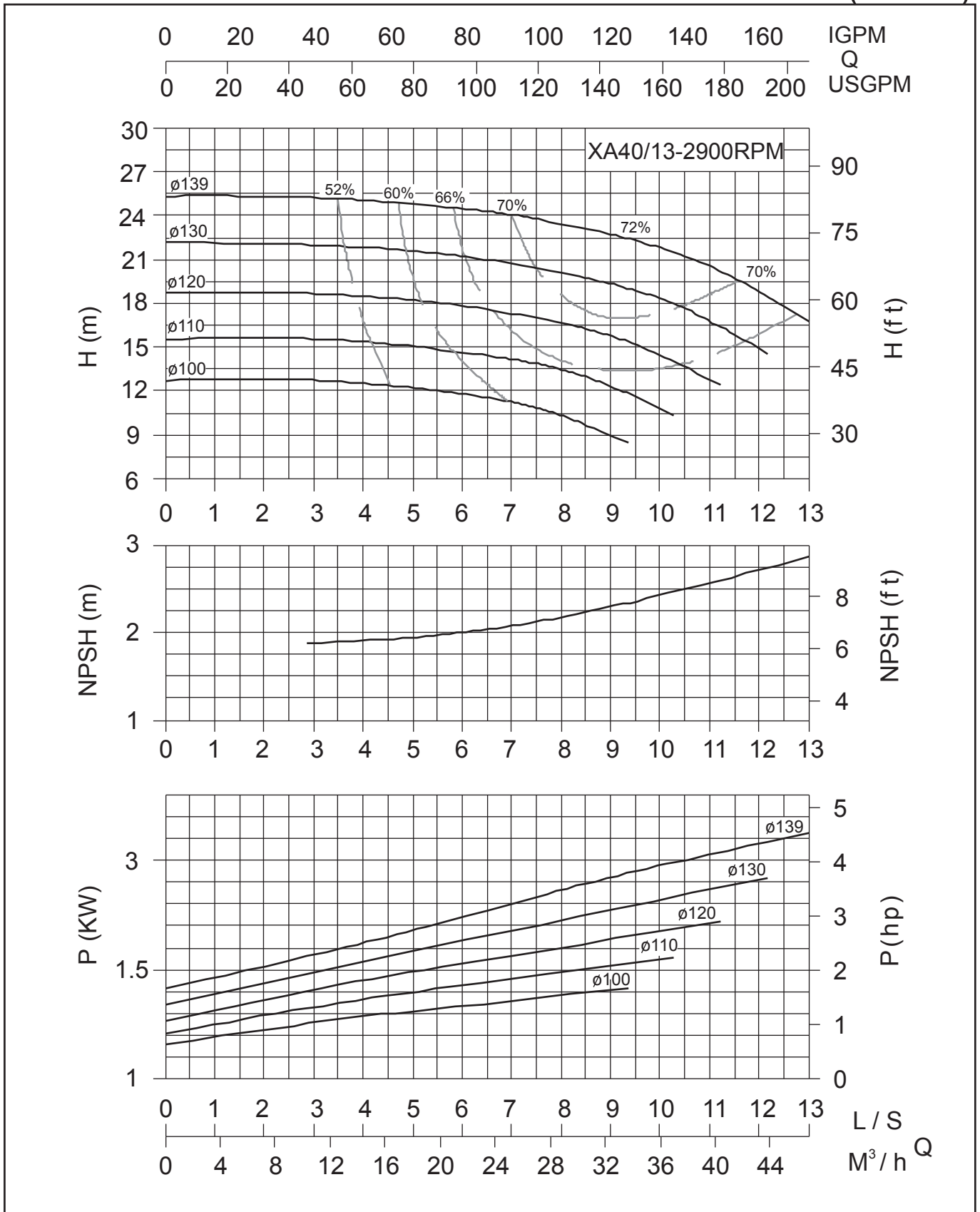





# END SUCTION PUMPS PERFORMANCE CURVES XA SERIES

## XA40/20-3500RPM (60HZ)

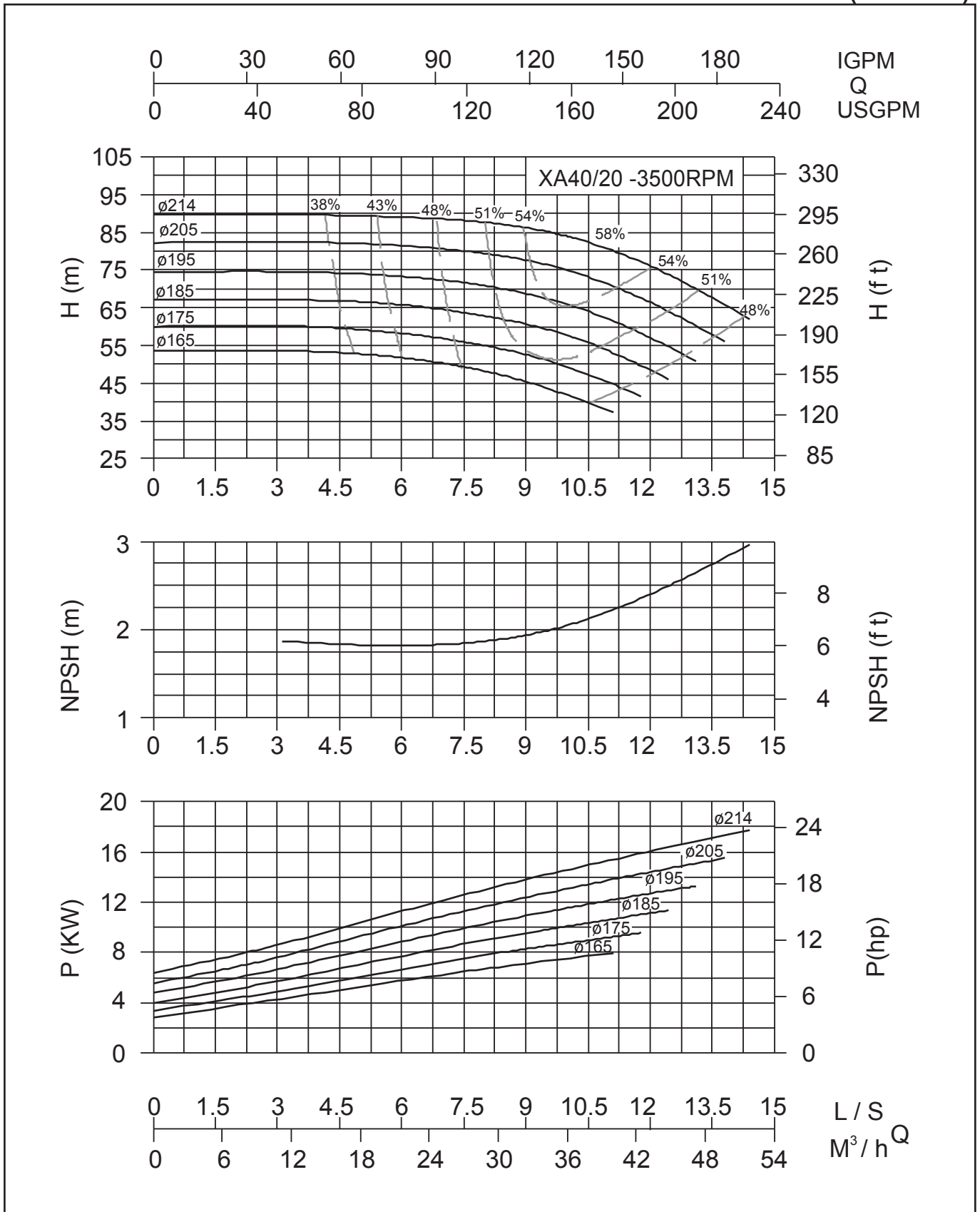

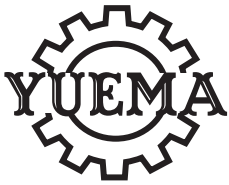

# END SUCTION PUMPS PERFORMANCE CURVES XA SERIES

## XA40/16-2900RPM (50HZ)

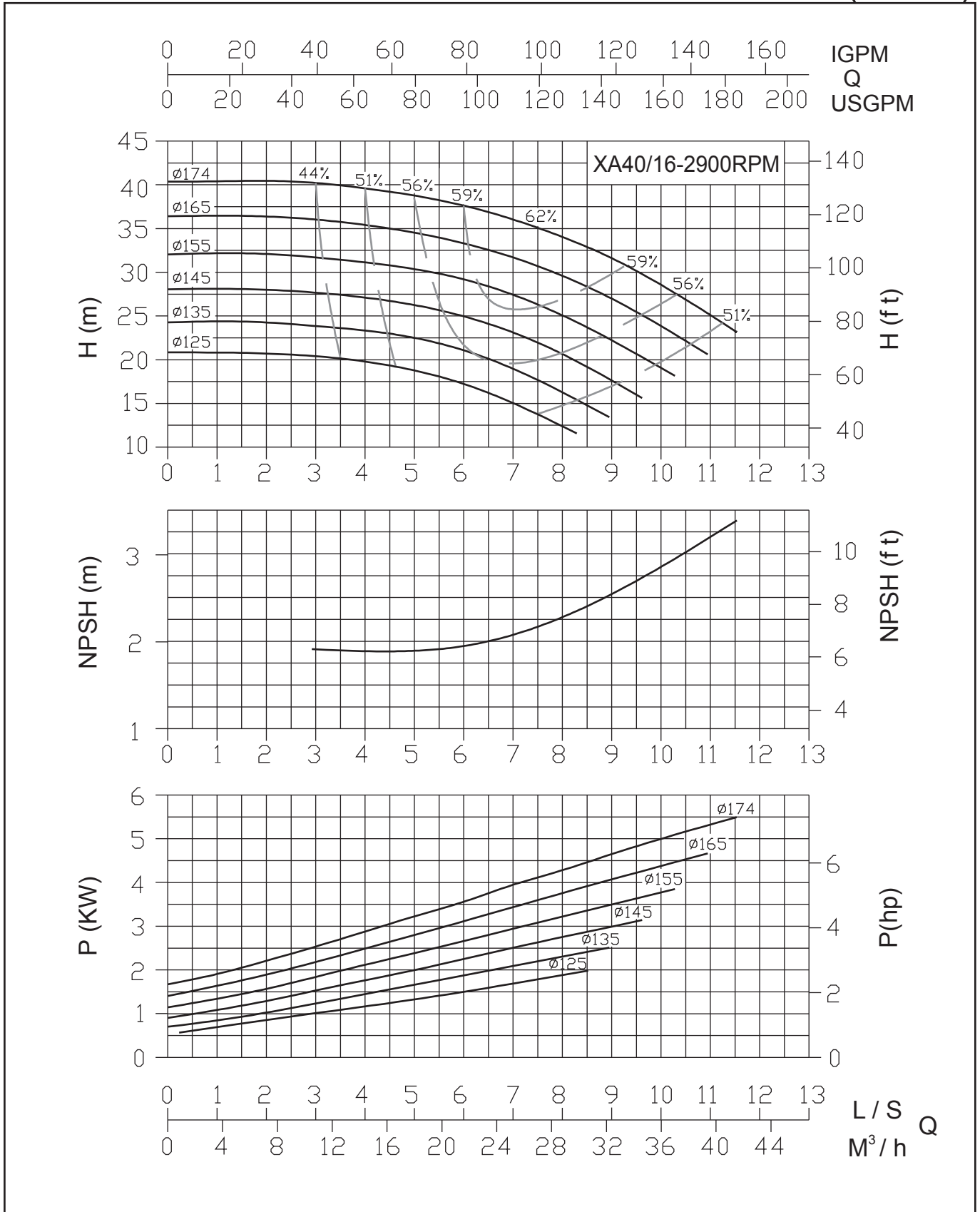



# END SUCTION PUMPS PERFORMANCE CURVES XA SERIES

## XA40/26-3500RPM (60HZ)

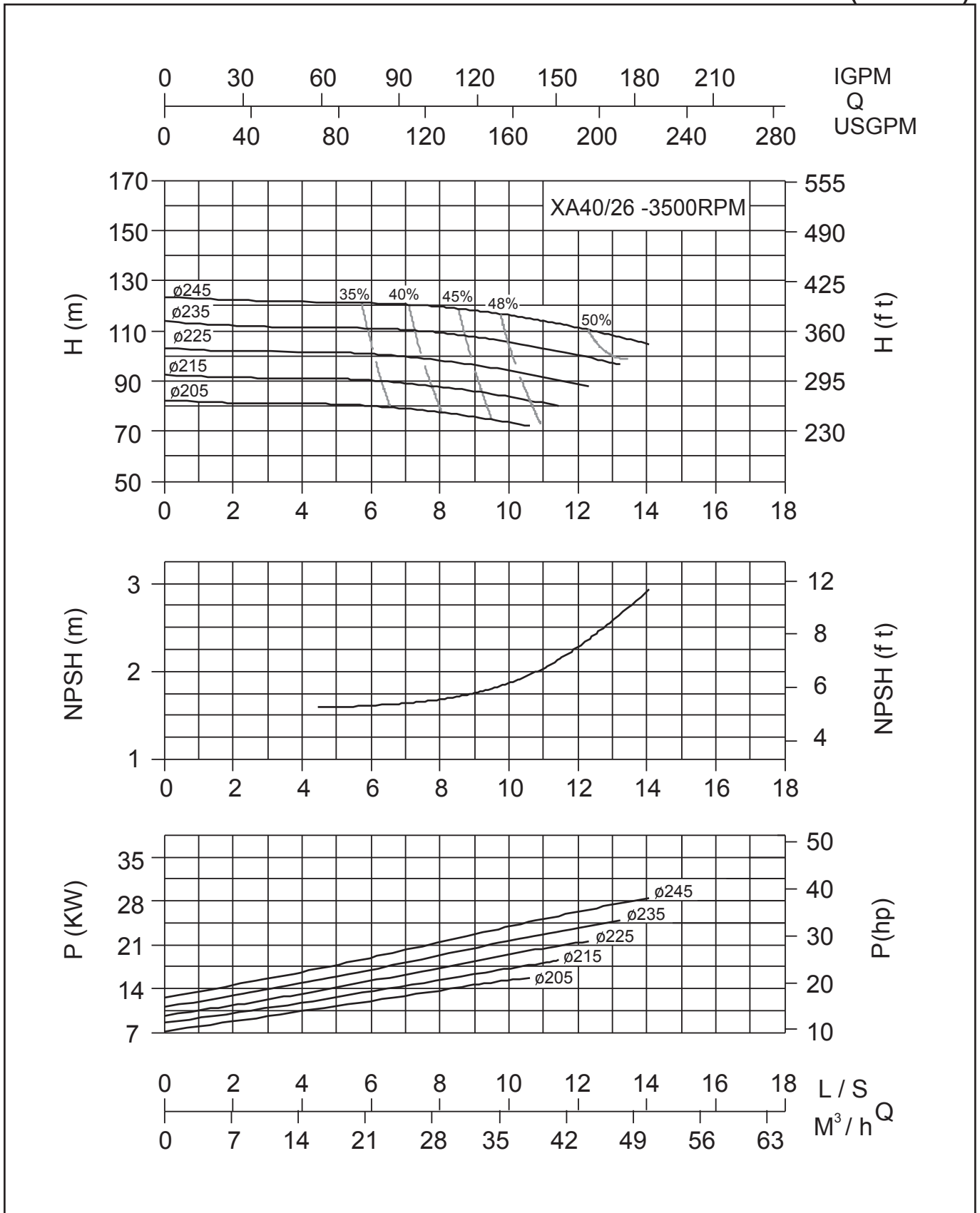



# END SUCTION PUMPS PERFORMANCE CURVES XA SERIES

## XA40/20-2900RPM (50HZ)

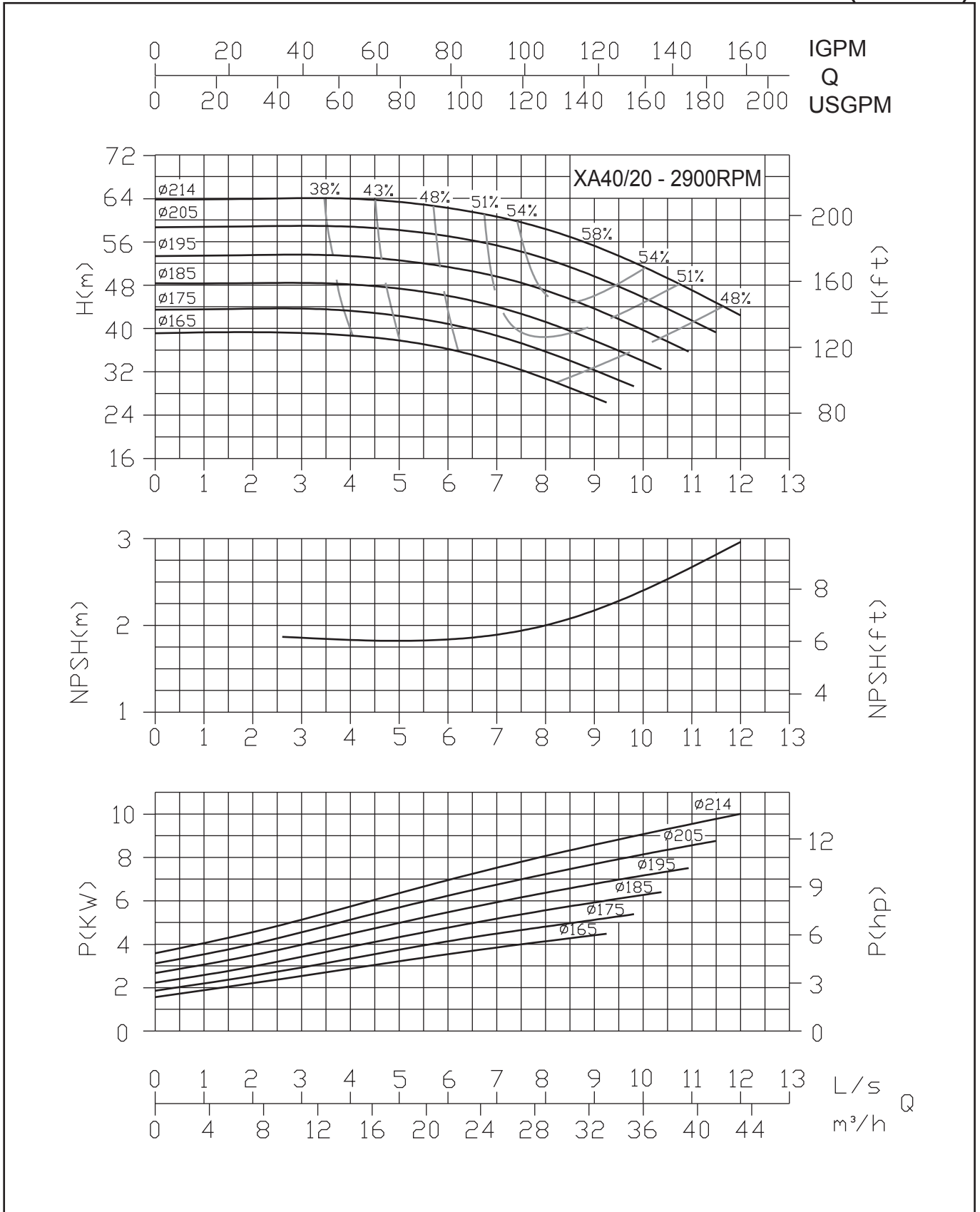



# END SUCTION PUMPS PERFORMANCE CURVES XA SERIES

## XA40/26H-3500RPM (60HZ)

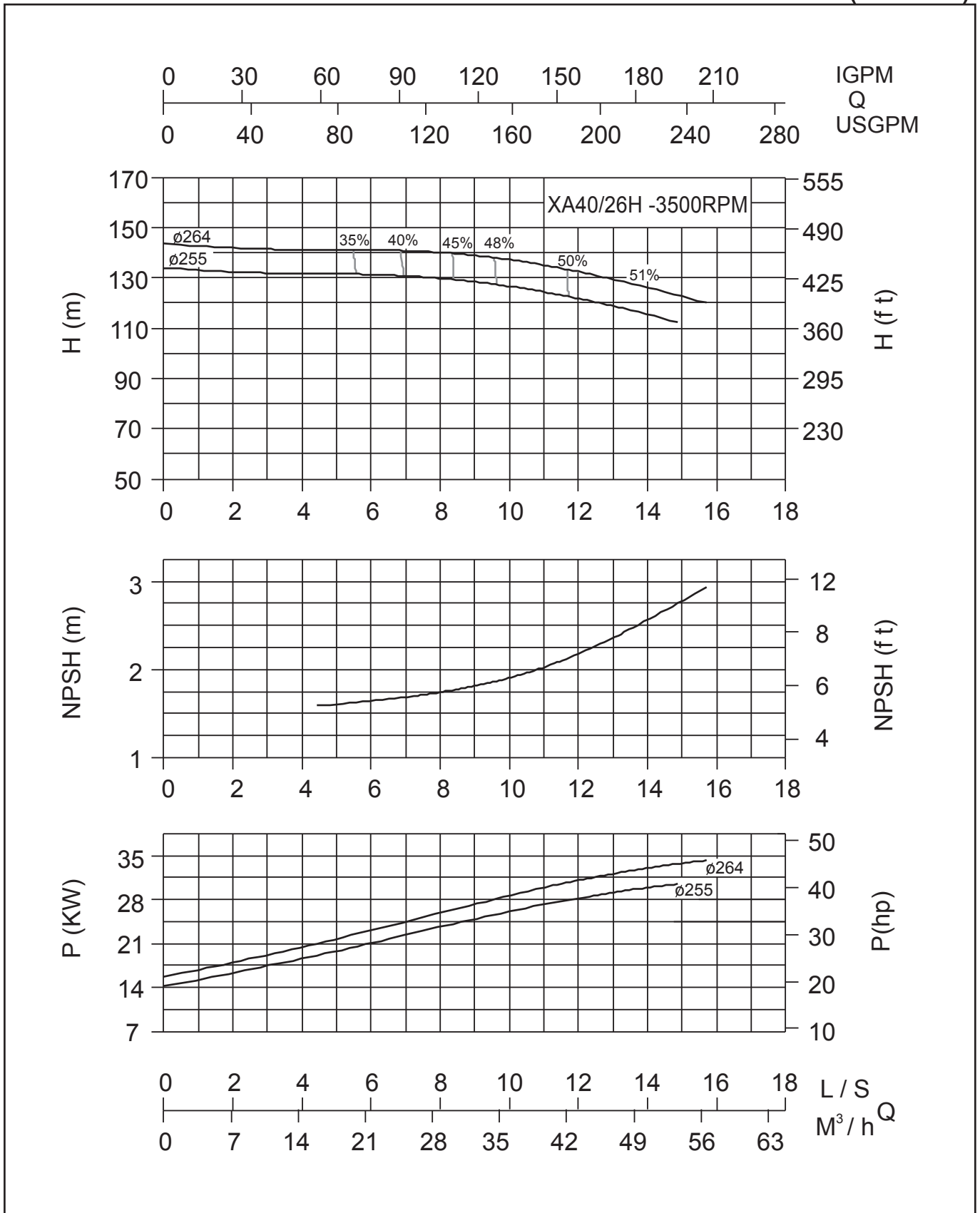



# END SUCTION PUMPS PERFORMANCE CURVES XA SERIES

## XA40/26-2900RPM (50HZ)

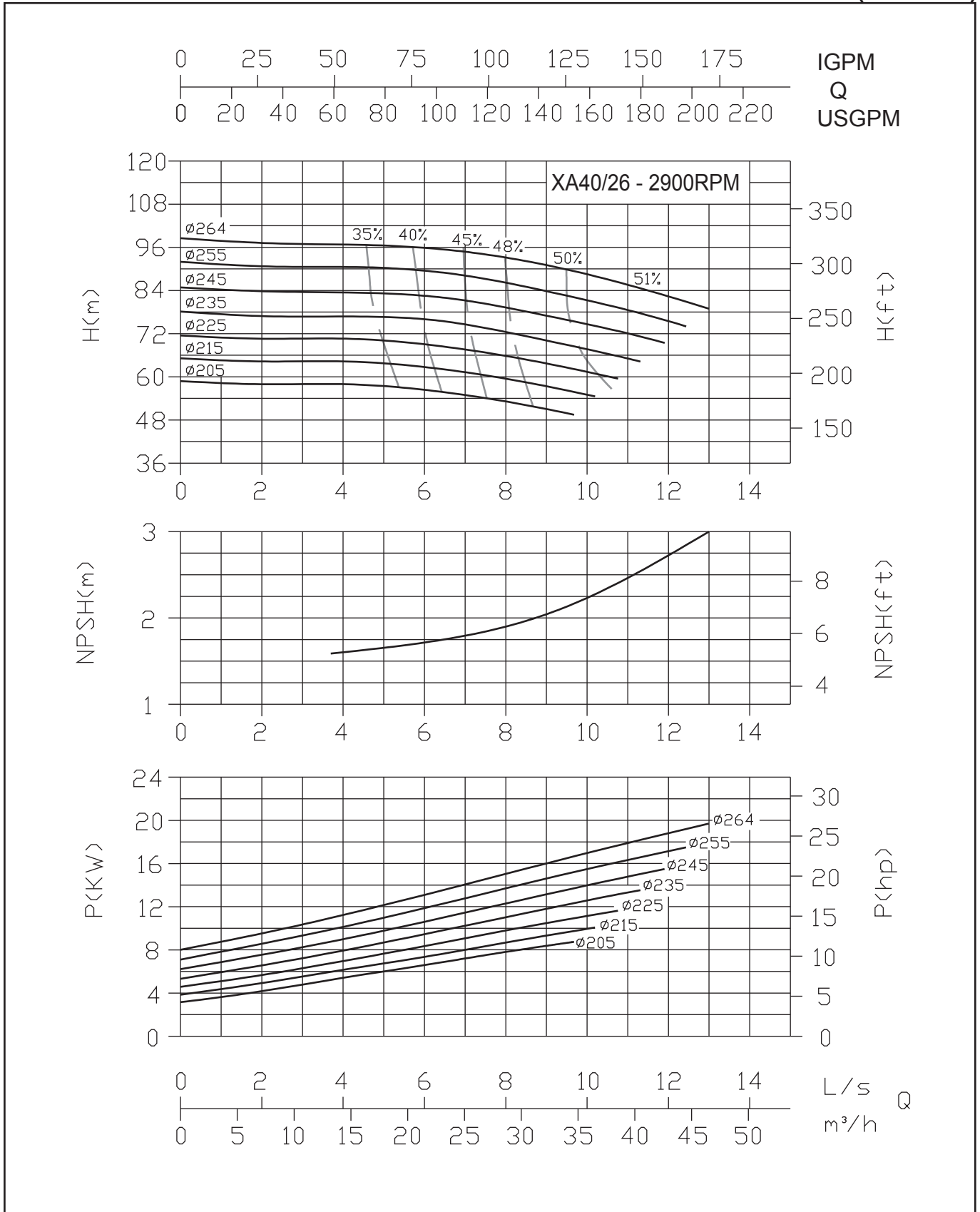



# END SUCTION PUMPS PERFORMANCE CURVES XA SERIES

## XA50/13-3500RPM (60HZ)

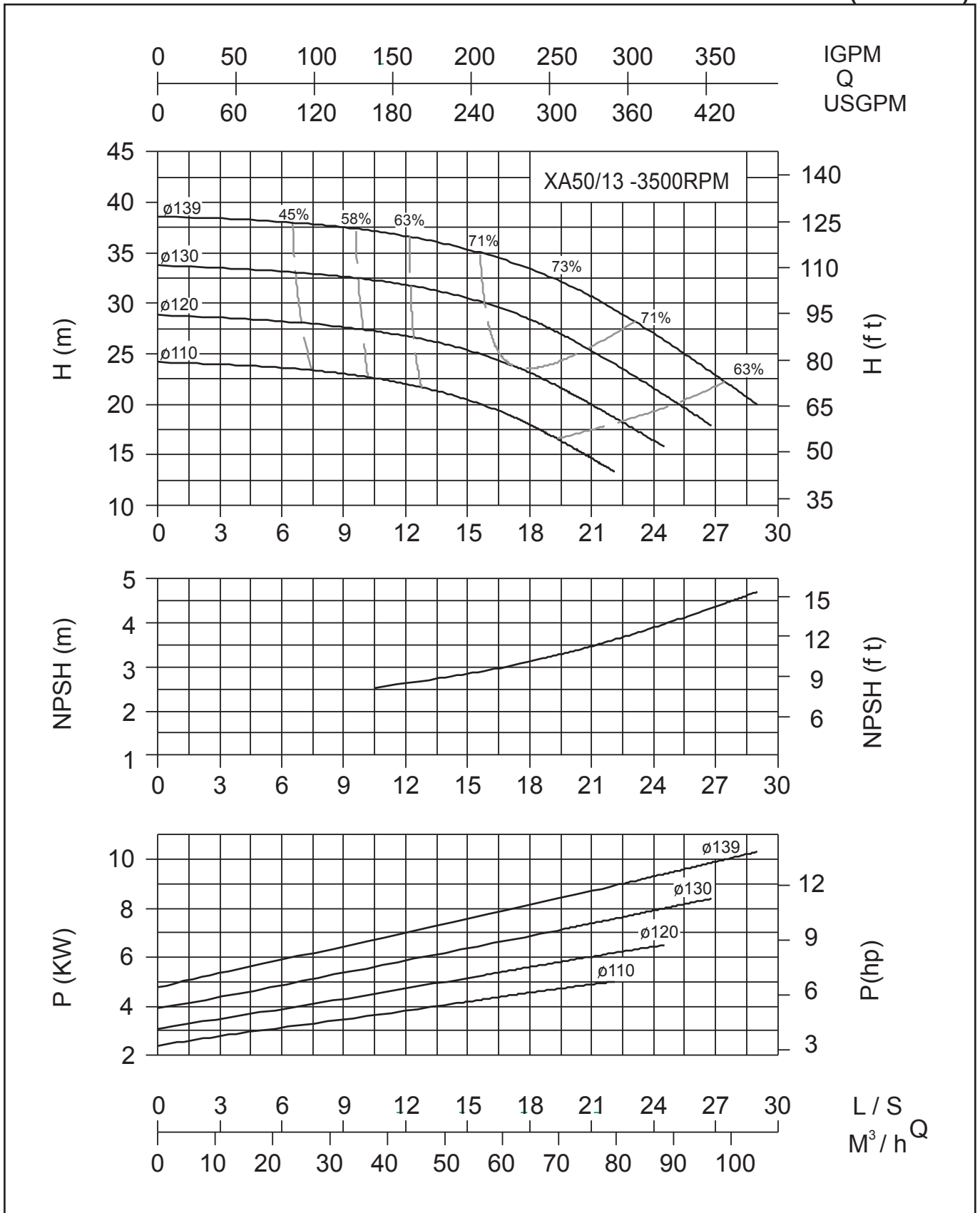



# END SUCTION PUMPS PERFORMANCE CURVES XA SERIES

XA40/32H-2900RPM (50HZ)  
XA40/32G-2900RPM (50HZ)

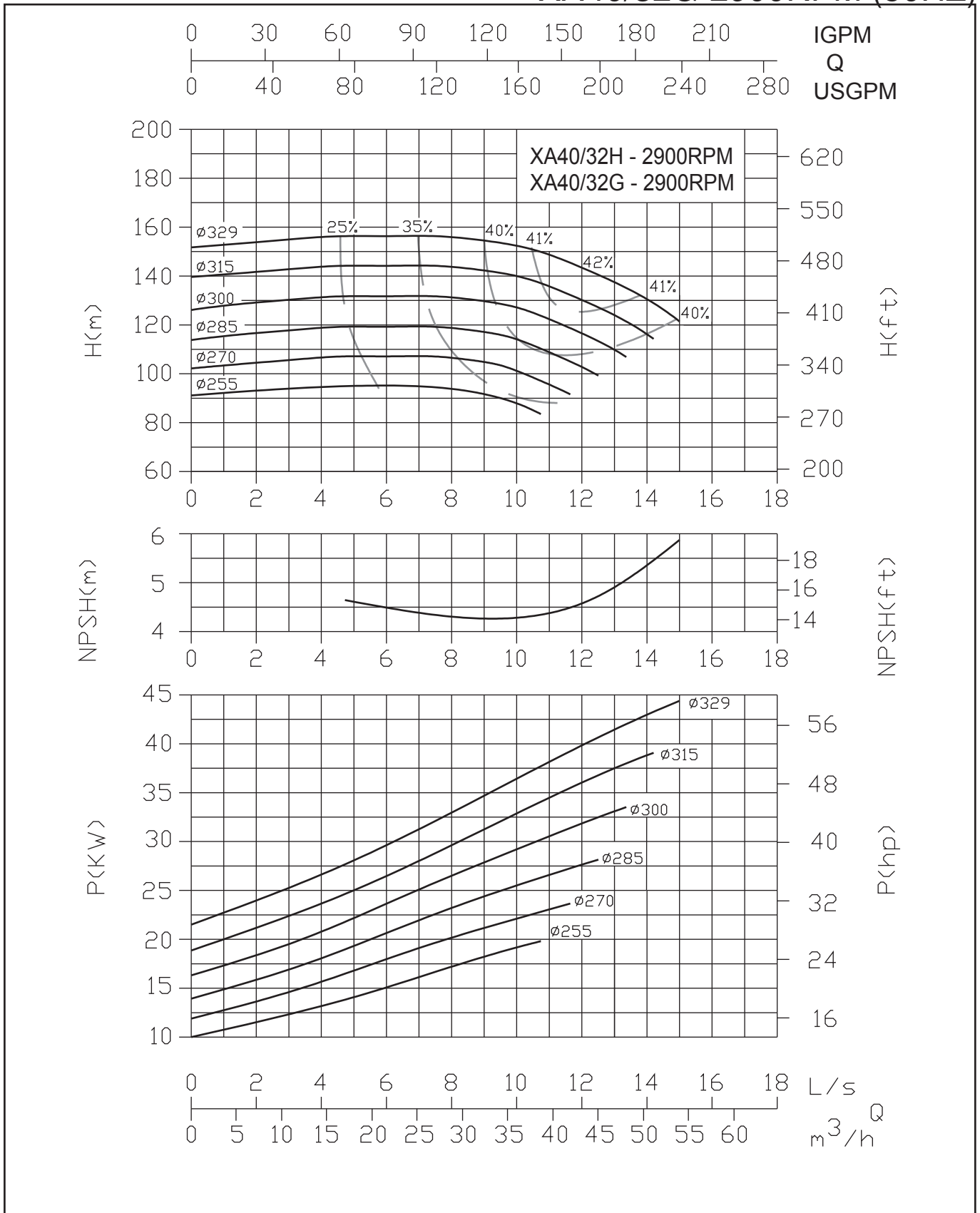



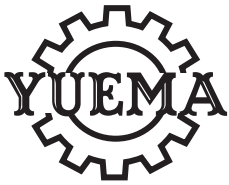

# END SUCTION PUMPS PERFORMANCE CURVES XA SERIES

## XA50/16-3500RPM (60HZ)

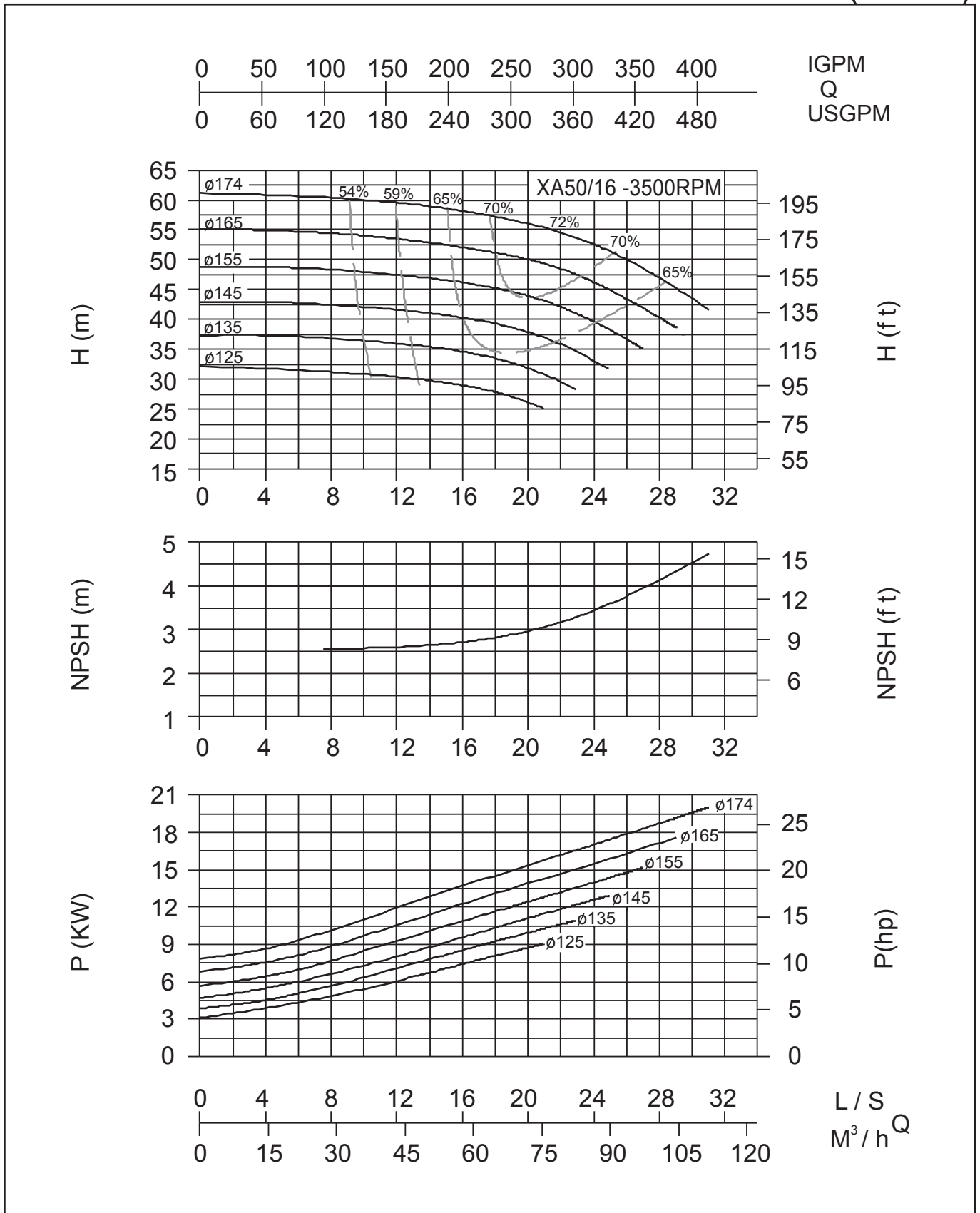



# END SUCTION PUMPS PERFORMANCE CURVES XA SERIES

## XA50/13-2900RPM (50HZ)

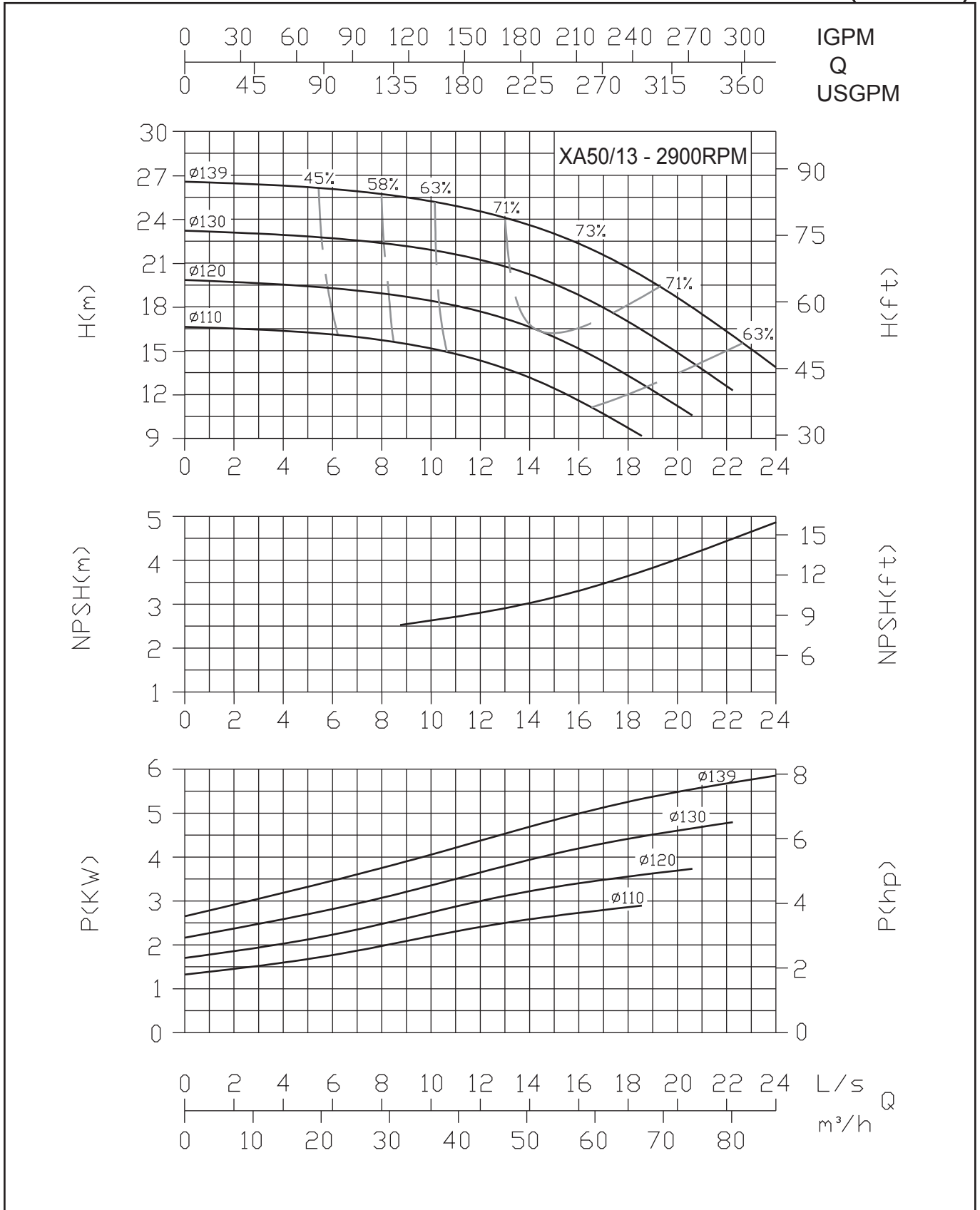



# END SUCTION PUMPS PERFORMANCE CURVES XA SERIES

## XA50/20-3500RPM (60HZ)

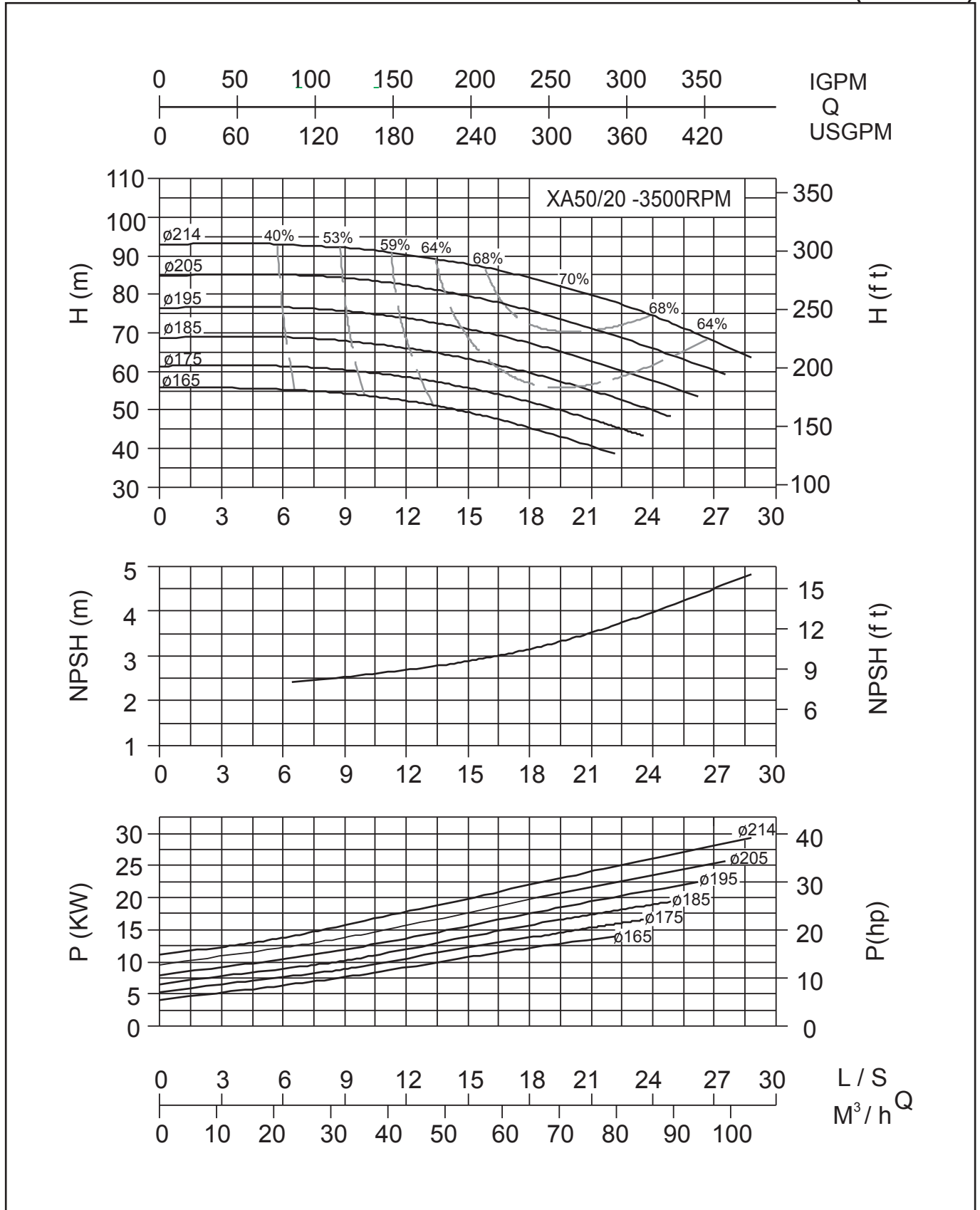

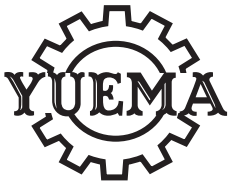

# END SUCTION PUMPS PERFORMANCE CURVES XA SERIES

## XA50/16-2900RPM (50HZ)

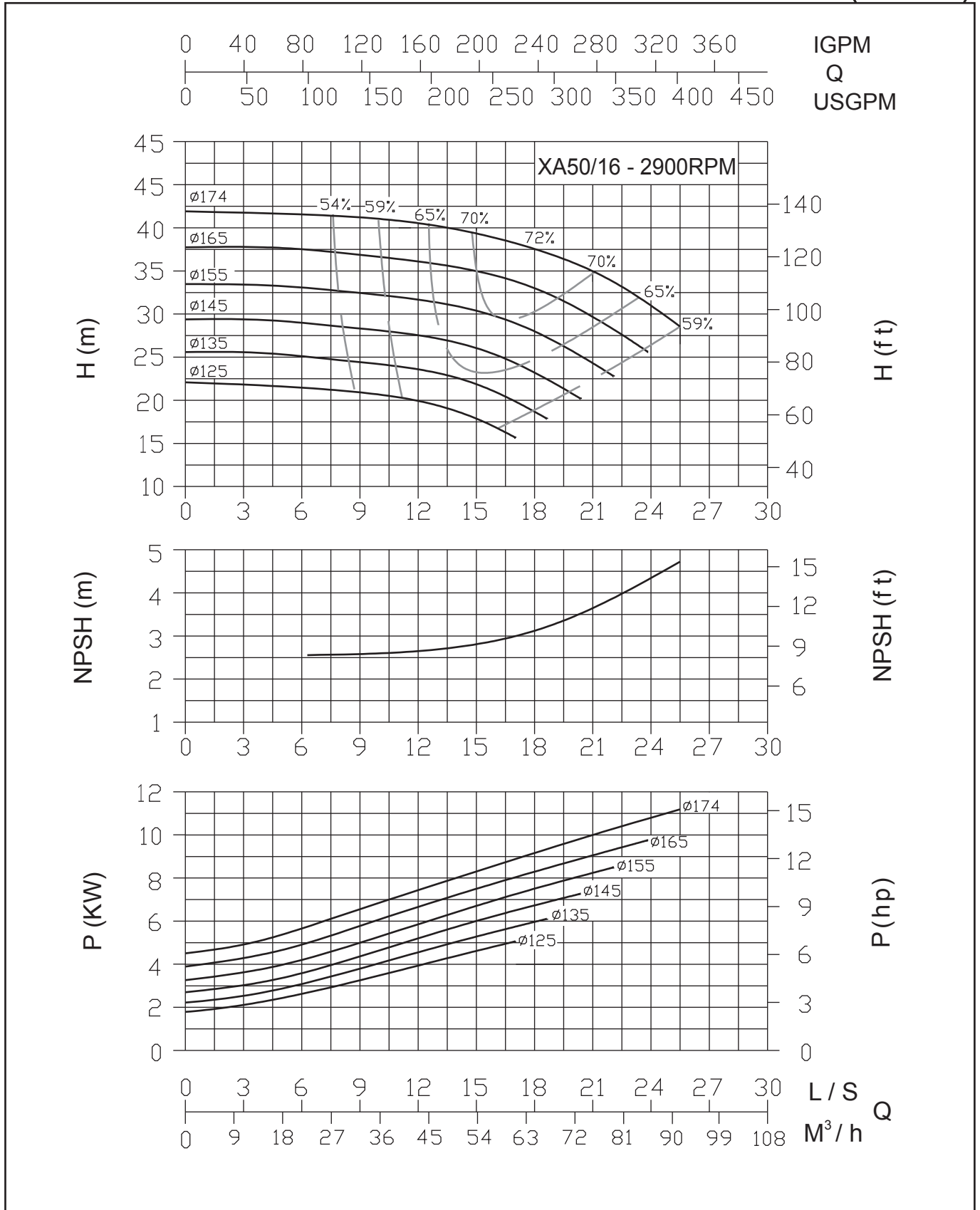

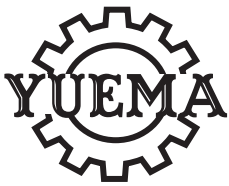

# END SUCTION PUMPS PERFORMANCE CURVES XA SERIES

## XA65/13-3500RPM (60HZ)

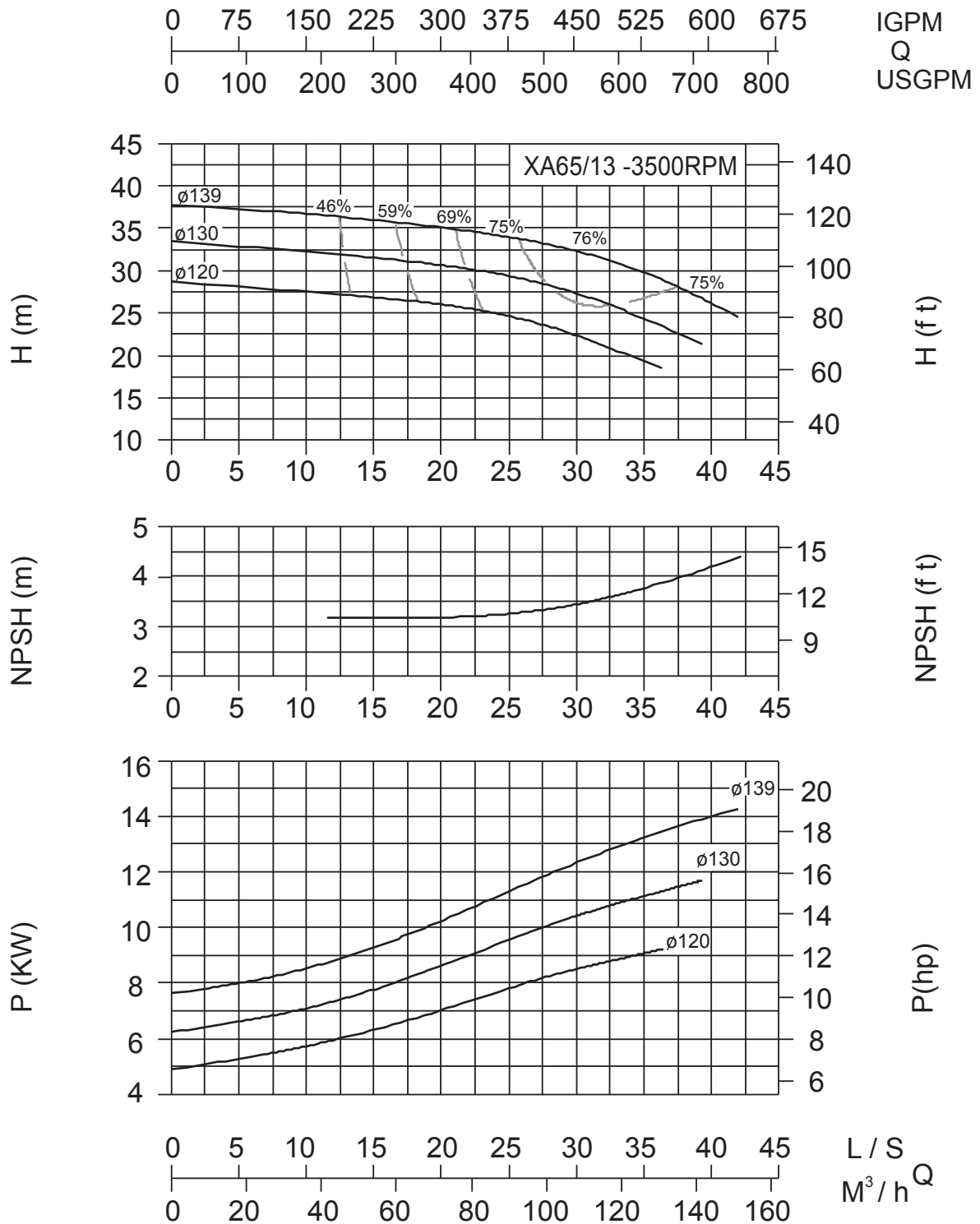

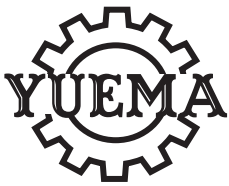

# END SUCTION PUMPS PERFORMANCE CURVES XA SERIES

## XA50/20-2900RPM (50HZ)

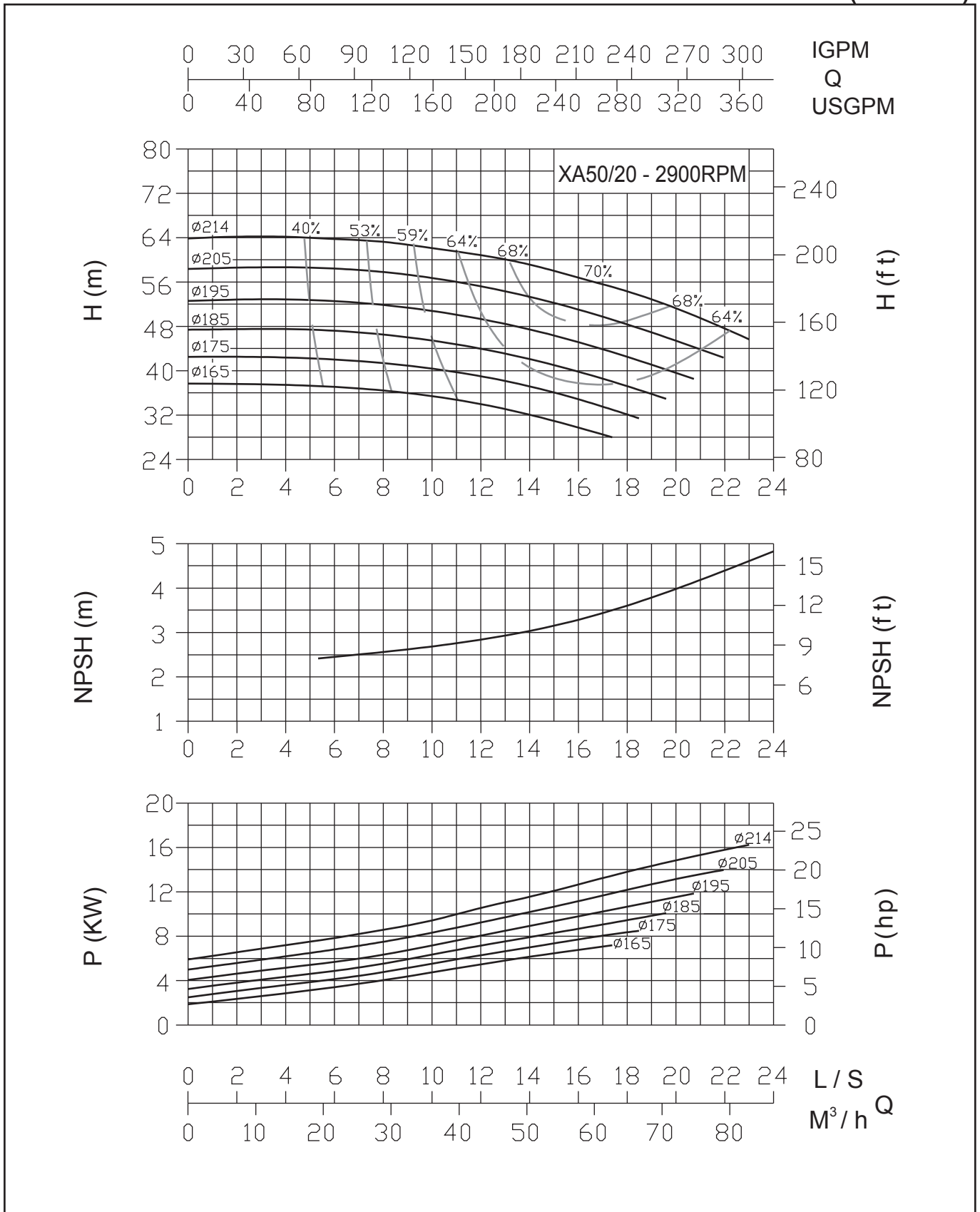

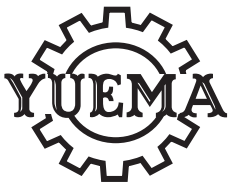

# END SUCTION PUMPS PERFORMANCE CURVES XA SERIES XA65/16-3500RPM (60HZ)

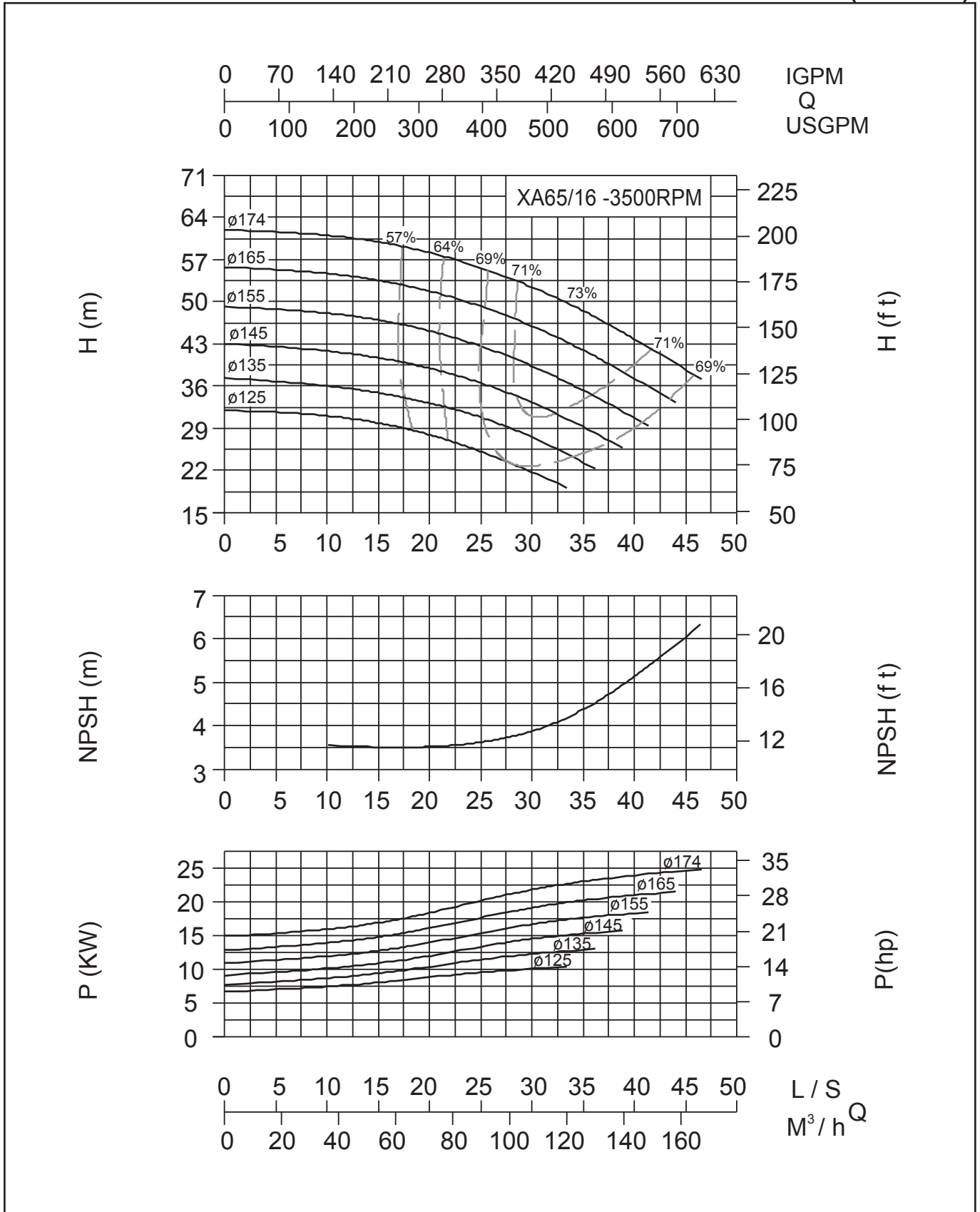

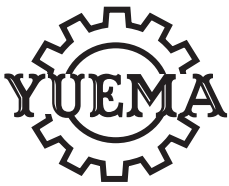

# END SUCTION PUMPS PERFORMANCE CURVES XA SERIES

## XA50/26H-2900RPM (50HZ)

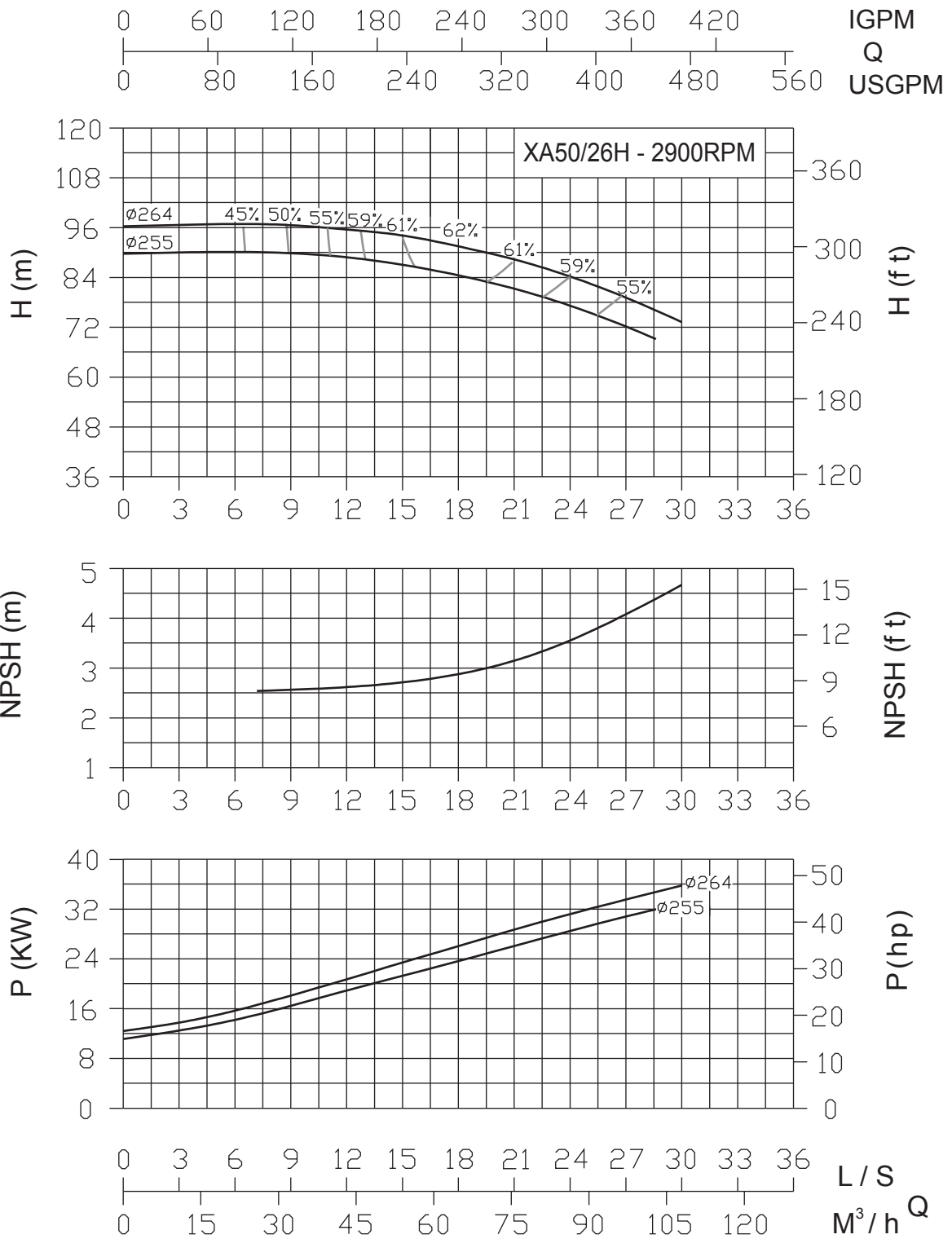



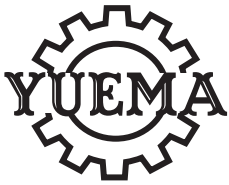

# END SUCTION PUMPS PERFORMANCE CURVES XA SERIES

XA65/20G-3500RPM (60HZ)

XA65/20H-3500RPM (60HZ)

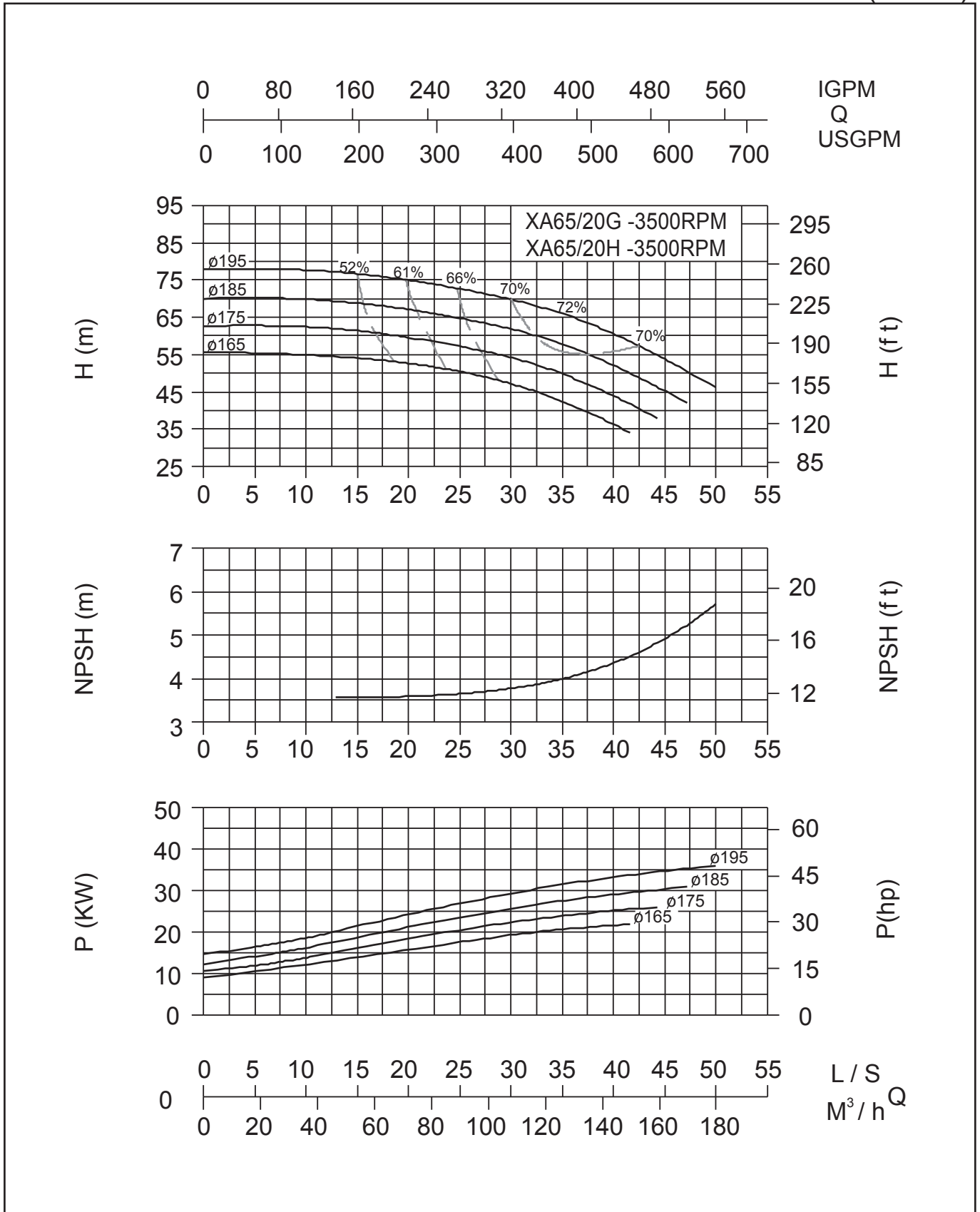



# END SUCTION PUMPS PERFORMANCE CURVES XA SERIES

## XA50/26-2900RPM (50HZ)

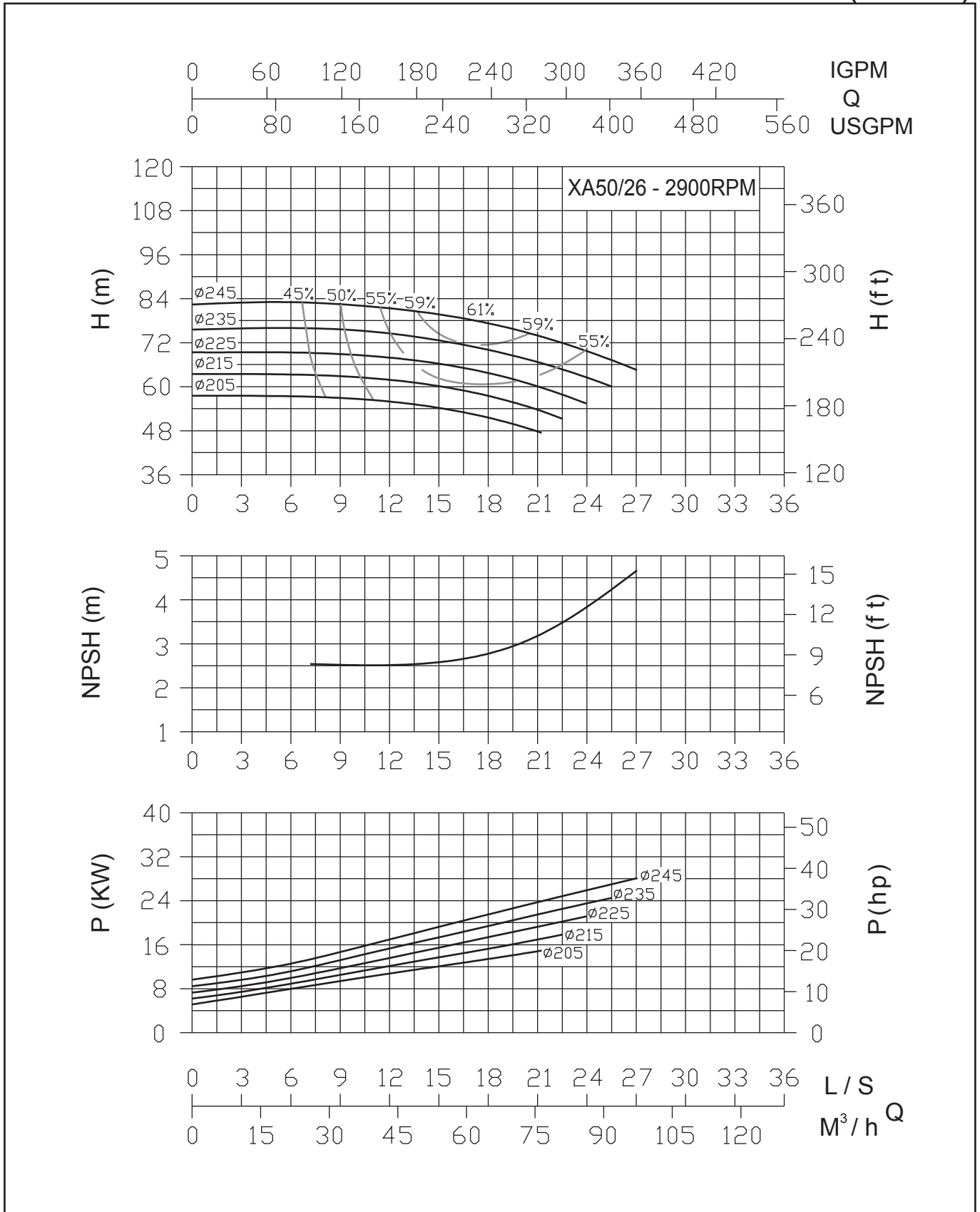

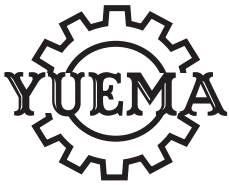

# END SUCTION PUMPS PERFORMANCE CURVES XA SERIES

## XA65/26-3500RPM (60HZ)

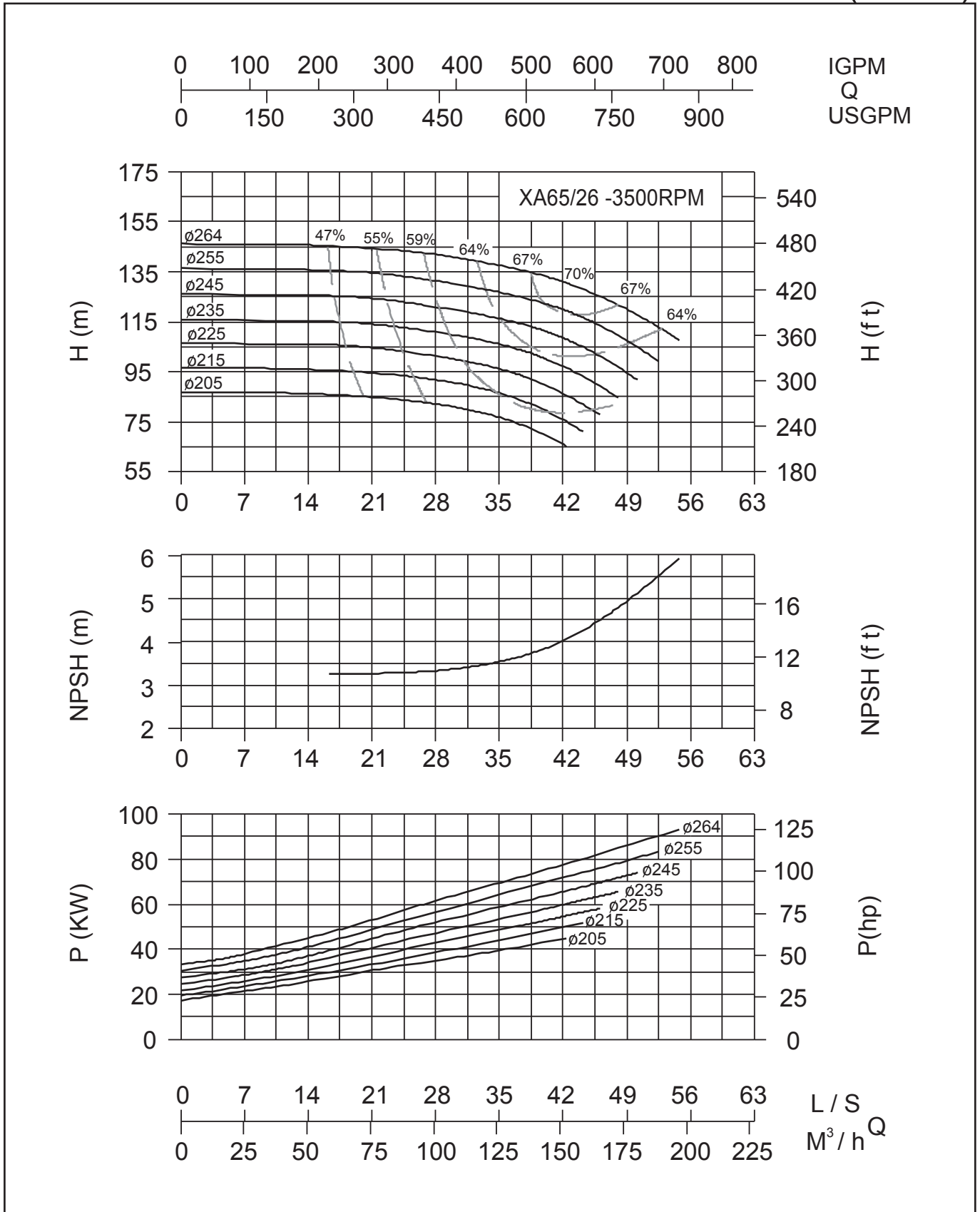



# END SUCTION PUMPS PERFORMANCE CURVES XA SERIES

XA50/32H-2900RPM (50HZ)

XA50/32G-2900RPM (50HZ)

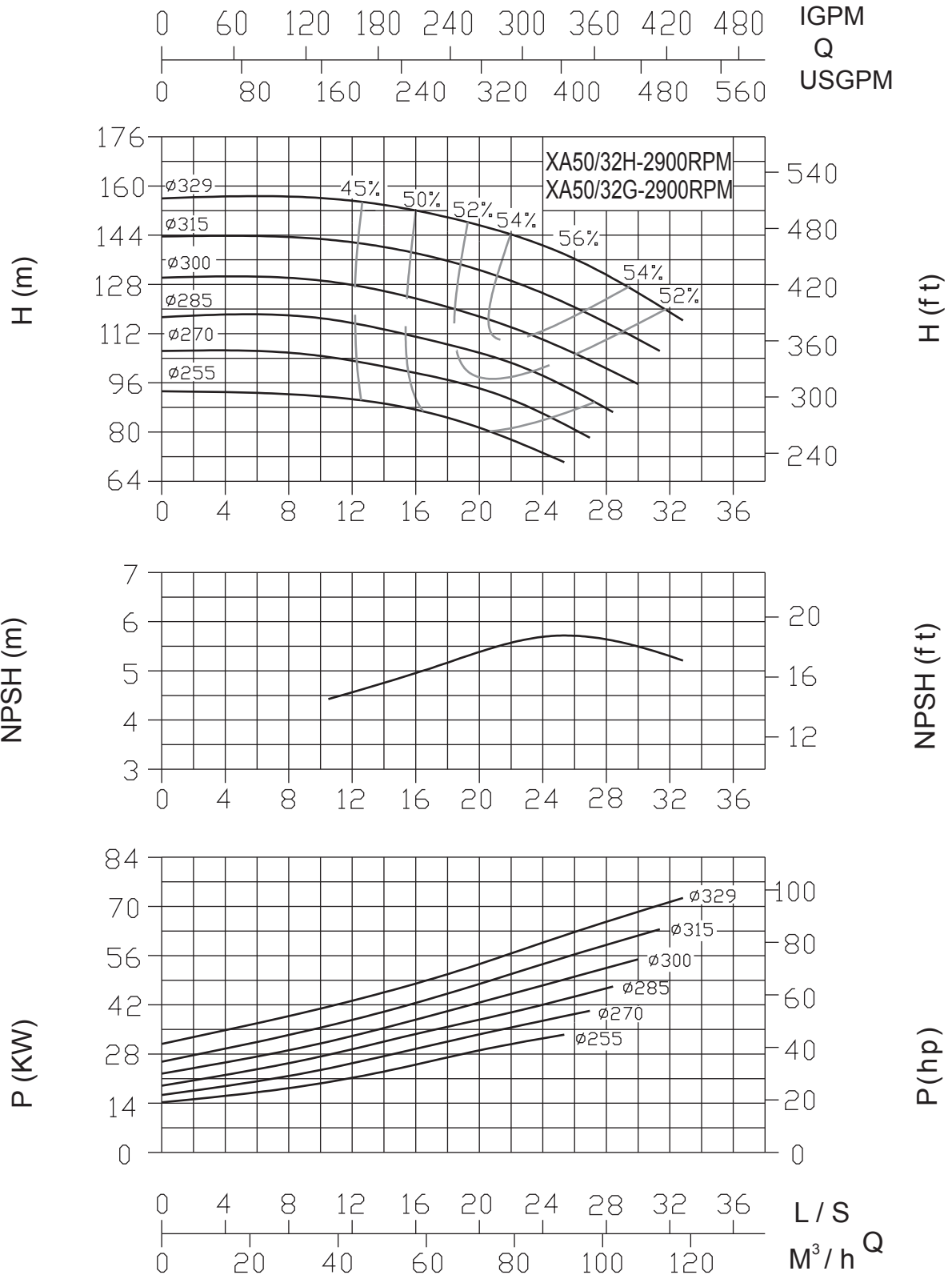



# END SUCTION PUMPS PERFORMANCE CURVES XA SERIES

## XA80/16-3500RPM (60HZ)

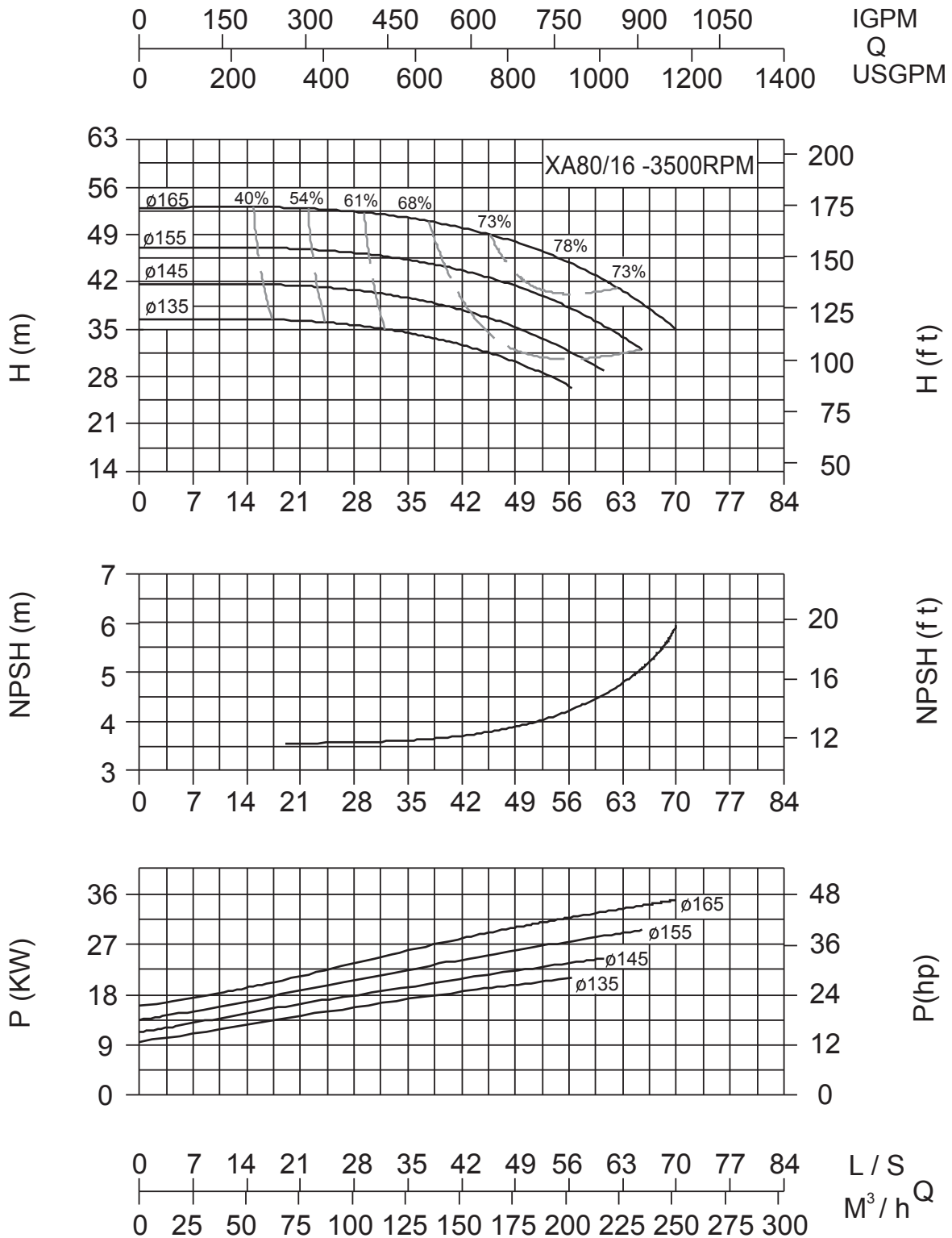



# END SUCTION PUMPS PERFORMANCE CURVES XA SERIES

## XA65/13-2900RPM (50HZ)

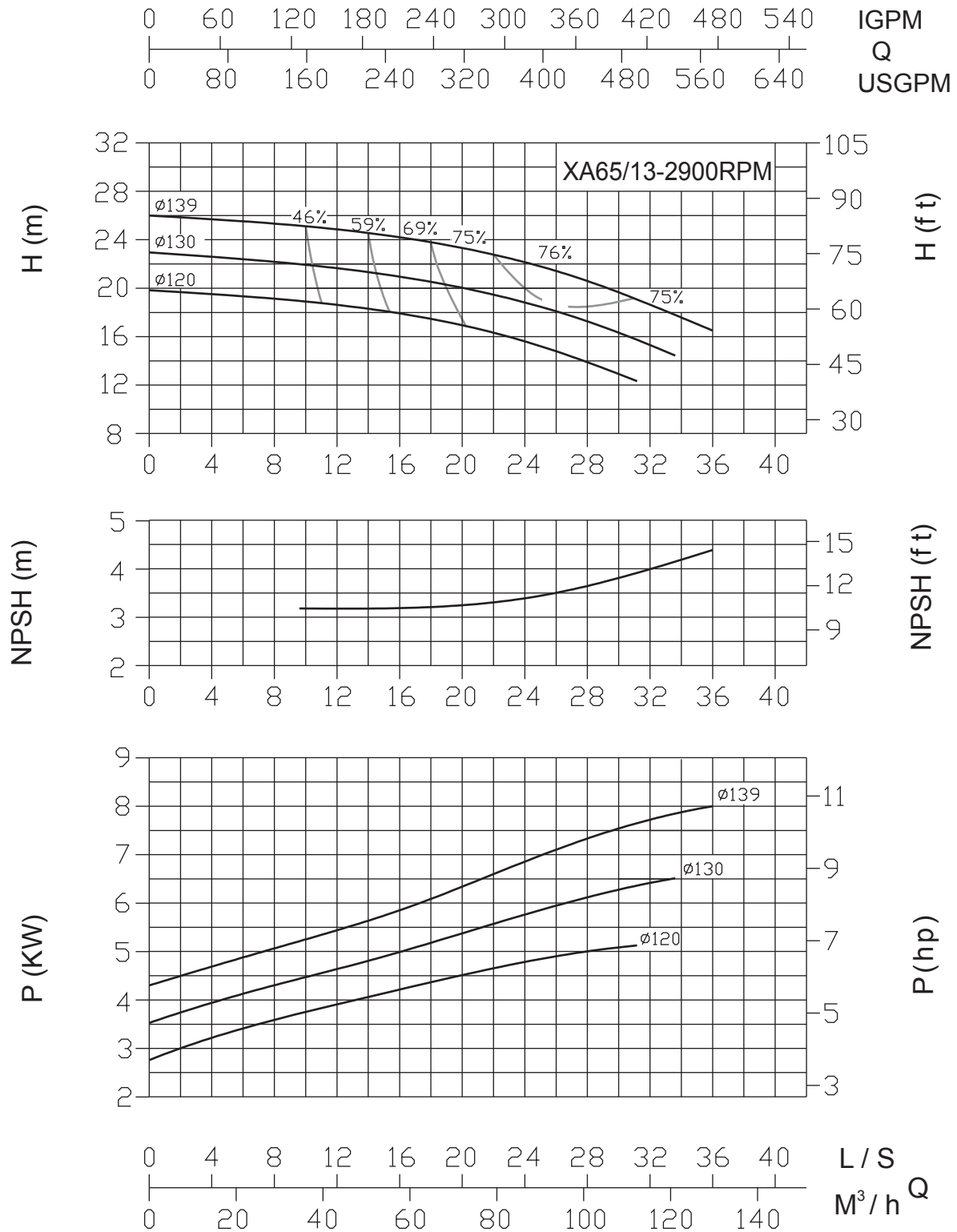

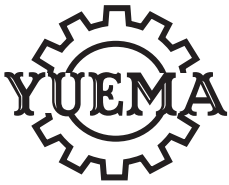

# END SUCTION PUMPS PERFORMANCE CURVES XA SERIES

## XA80/20-3500RPM (60HZ)

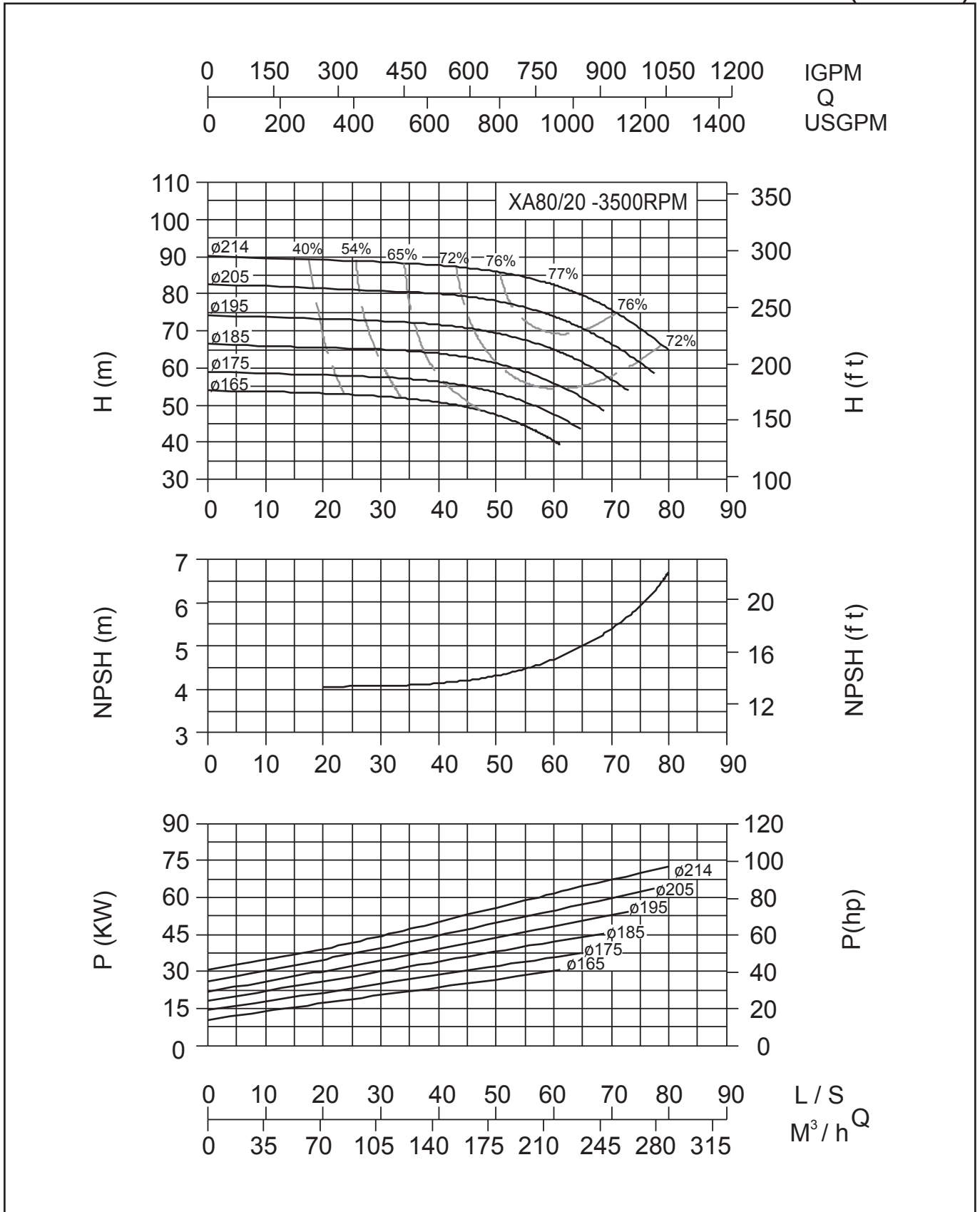



# END SUCTION PUMPS PERFORMANCE CURVES XA SERIES

## XA65/16-2900RPM (50HZ)

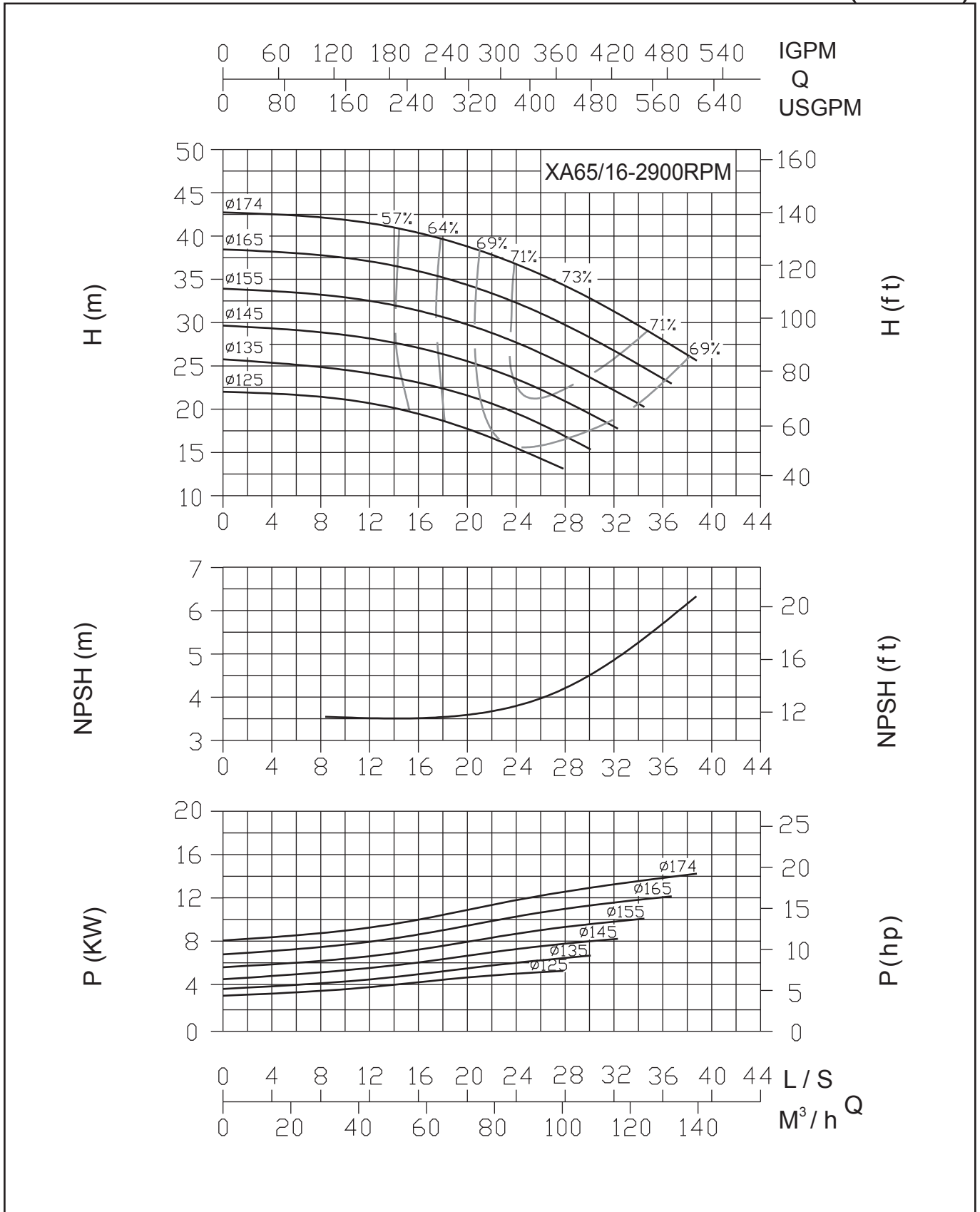





# END SUCTION PUMPS PERFORMANCE CURVES XA SERIES

## XA80/26-3500RPM (60HZ)

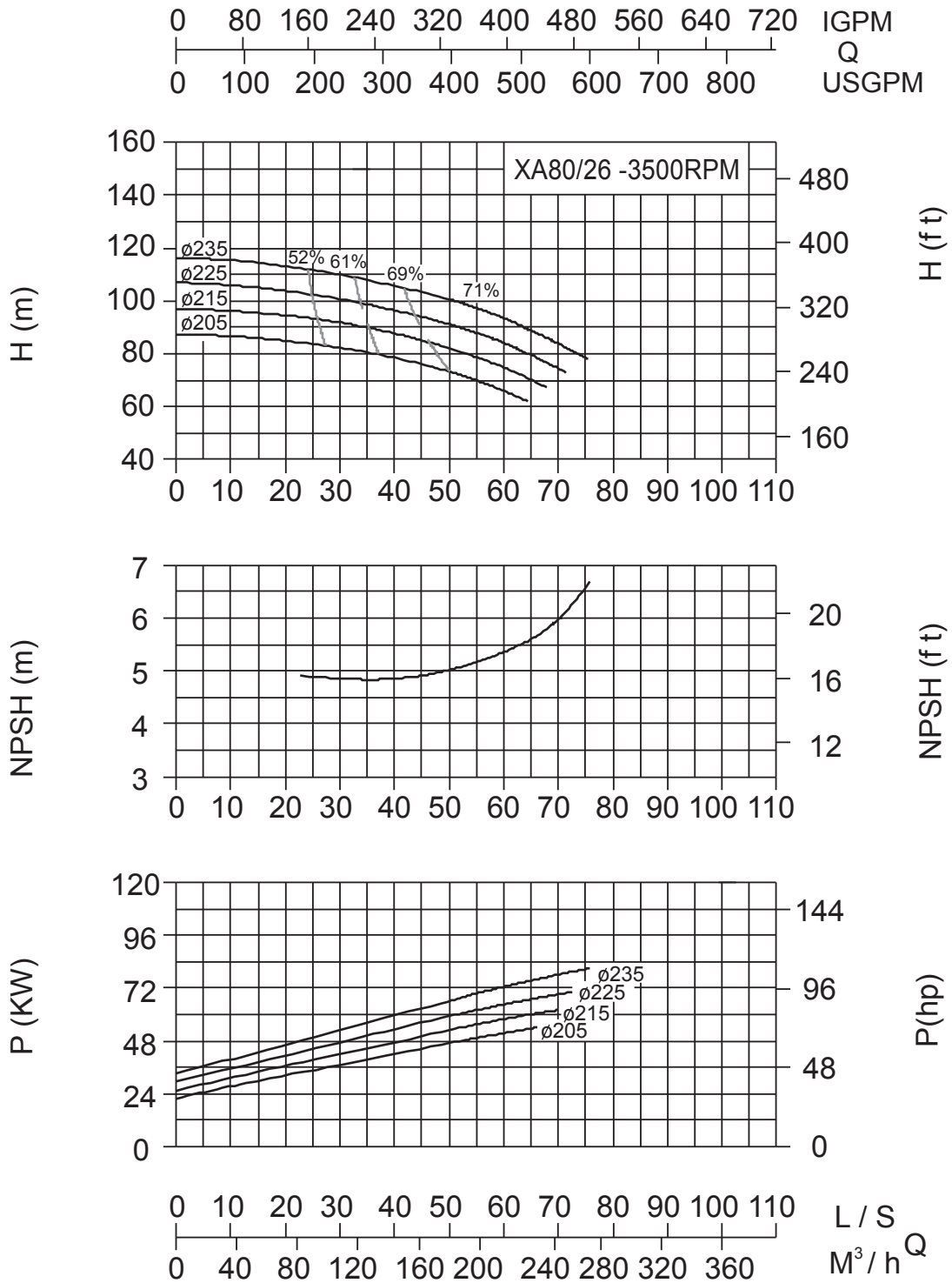

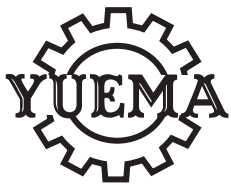

# END SUCTION PUMPS PERFORMANCE CURVES XA SERIES

## XA65/20-2900RPM (50HZ)

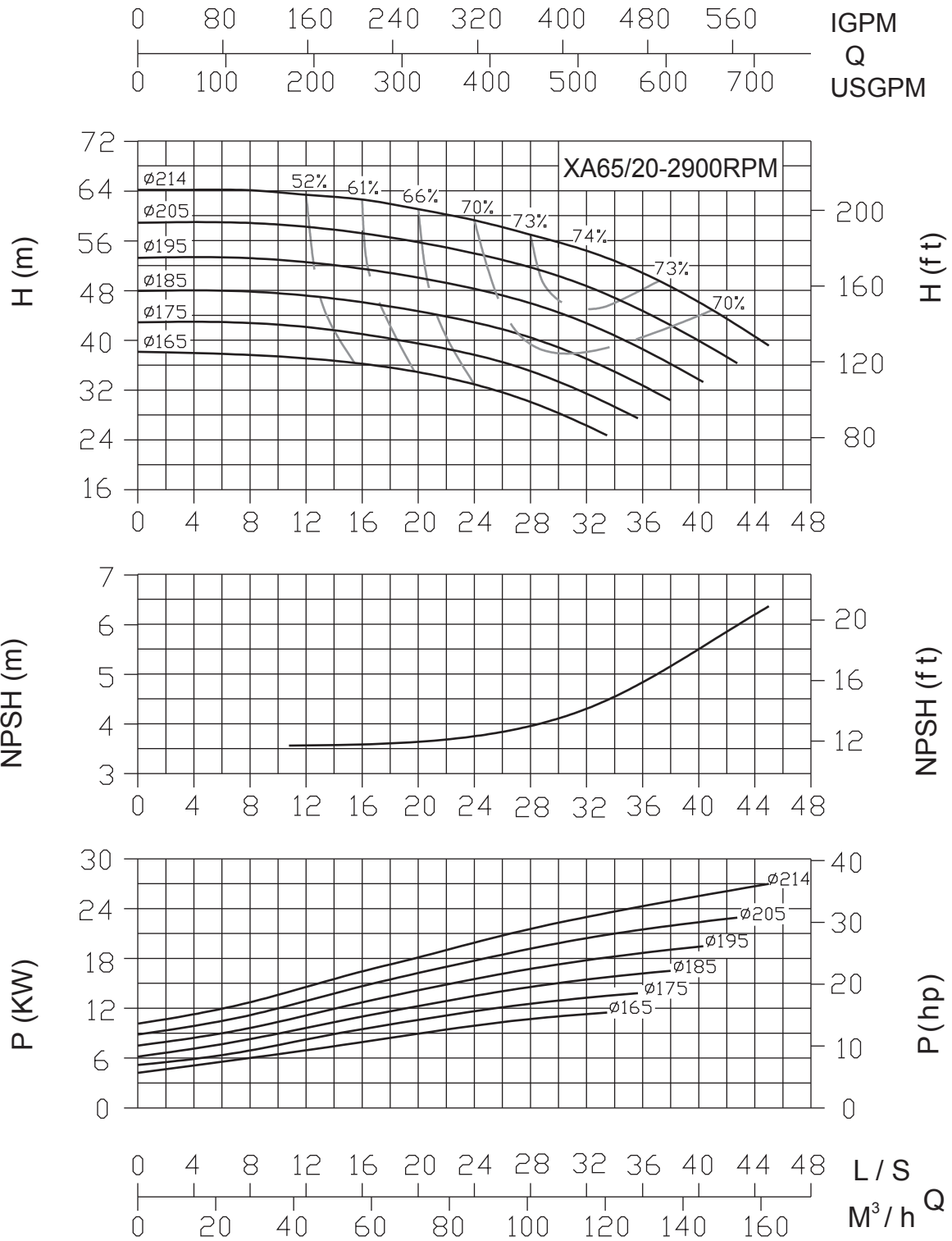



# END SUCTION PUMPS PERFORMANCE CURVES XA SERIES

## XA80/26H-3500RPM (60HZ)

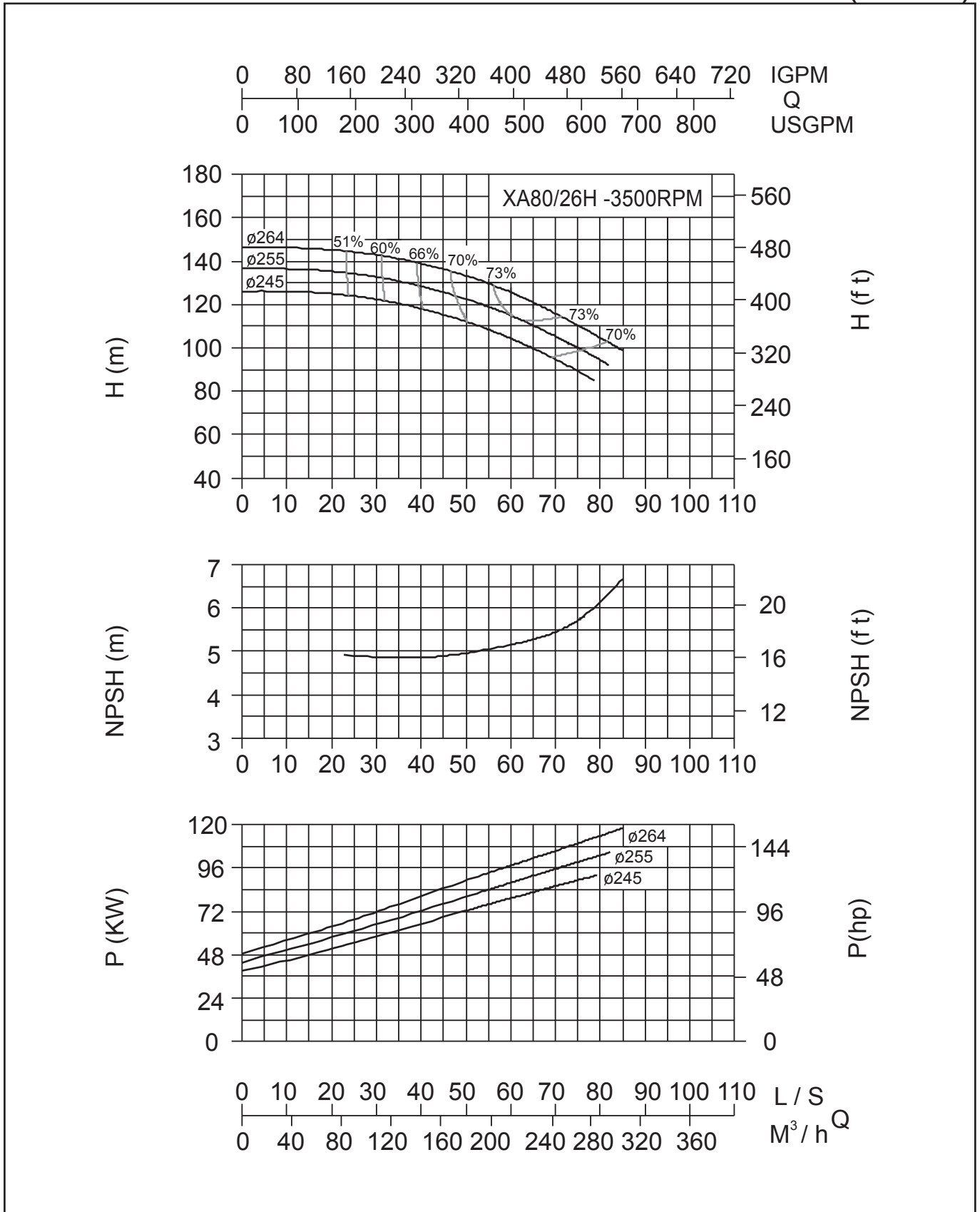



# END SUCTION PUMPS PERFORMANCE CURVES XA SERIES

## XA65/26-2900RPM (50HZ)

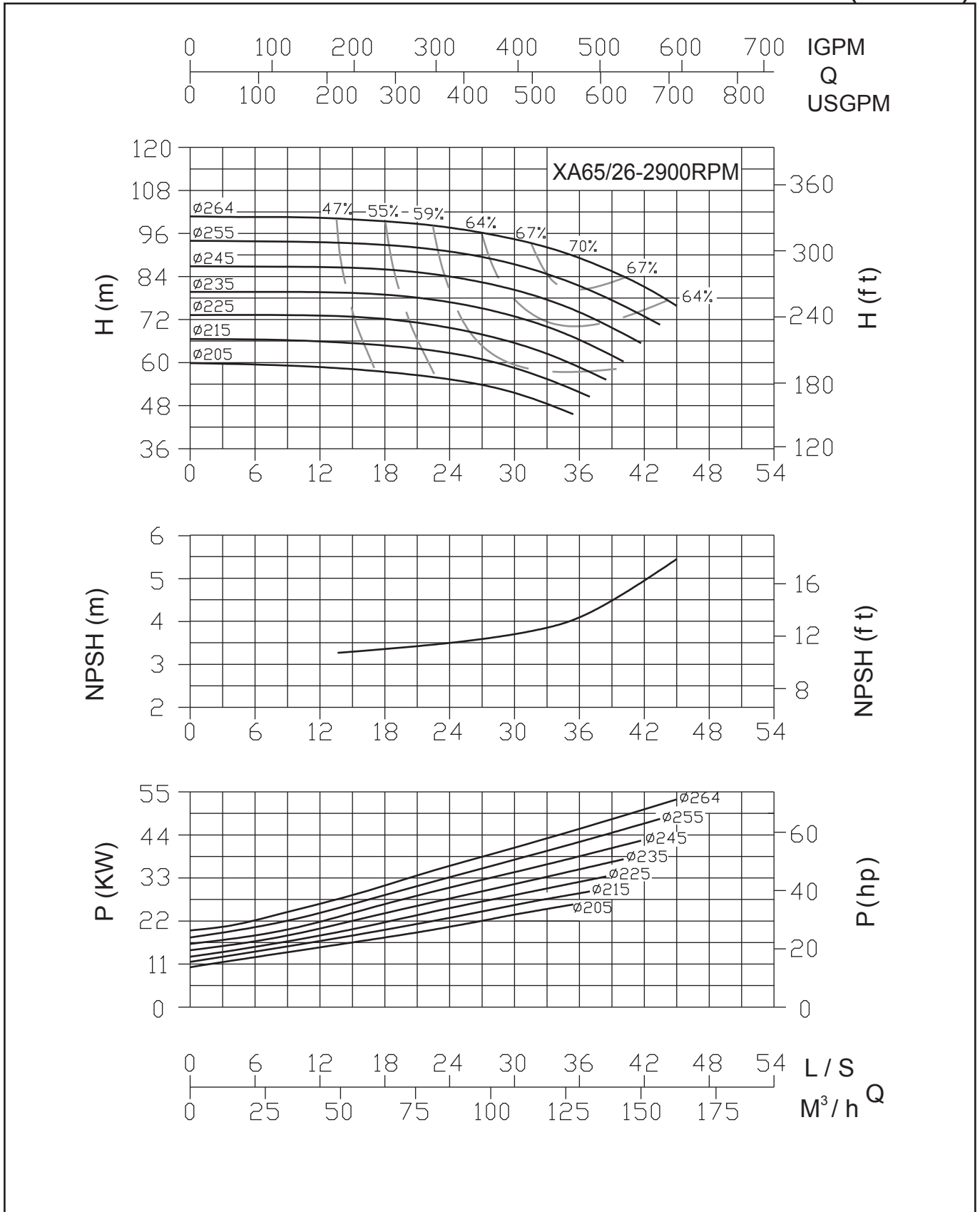



# END SUCTION PUMPS PERFORMANCE CURVES XA SERIES

## XA100/16-3500RPM (60HZ)

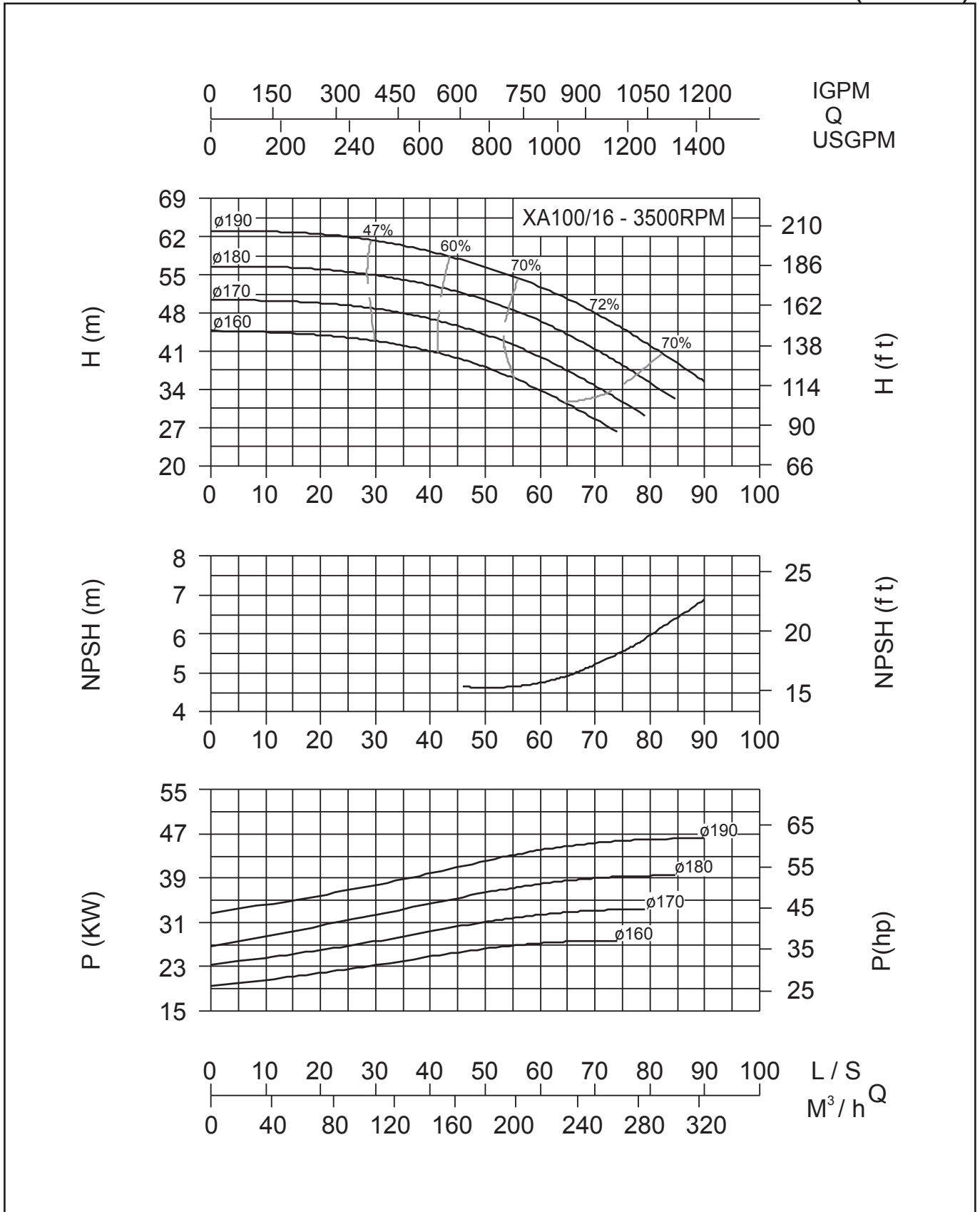

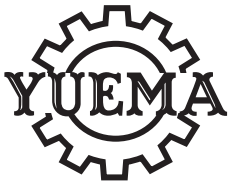

# END SUCTION PUMPS PERFORMANCE CURVES XA SERIES

XA65/32H-2900RPM (50HZ)

XA65/32G-2900RPM (50HZ)

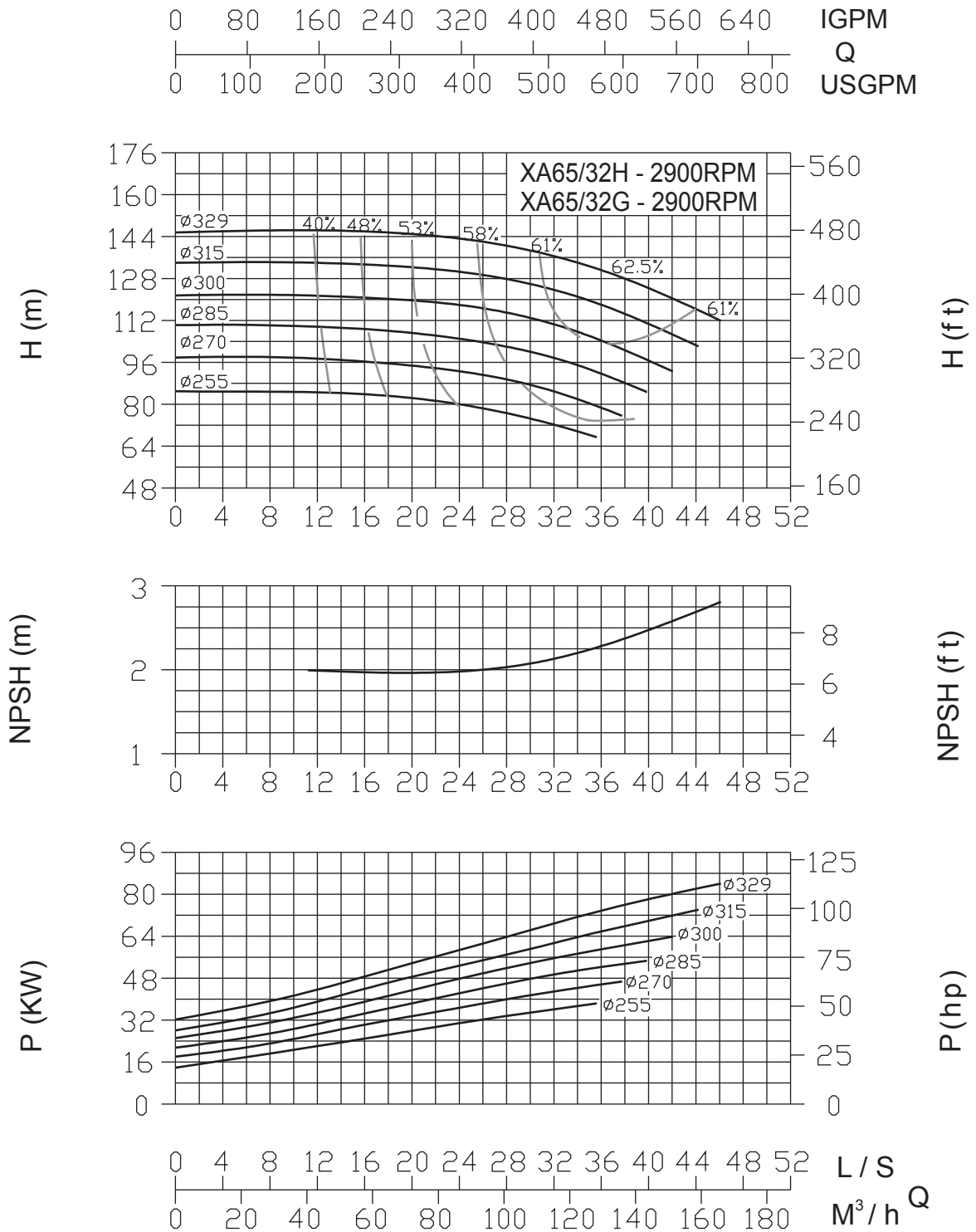

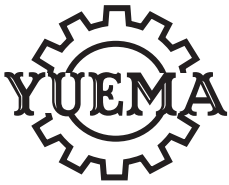

# END SUCTION PUMPS PERFORMANCE CURVES XA SERIES

## XA100/20-3500RPM (60HZ)

0 200 400 600 800 1000 1200 1400 IGPM  
 0 250 500 750 1000 1250 1500 1750 Q  
 USGPM

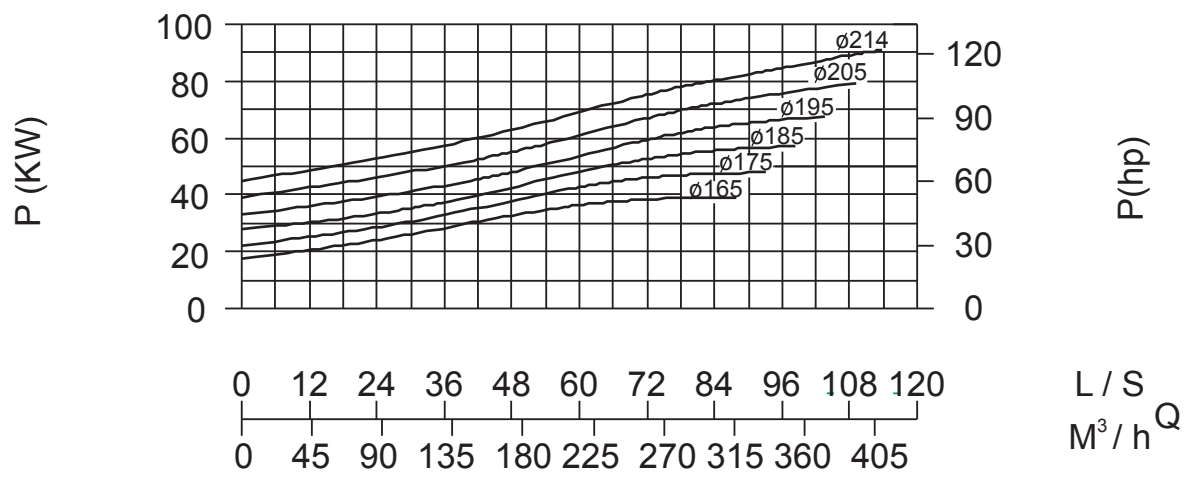
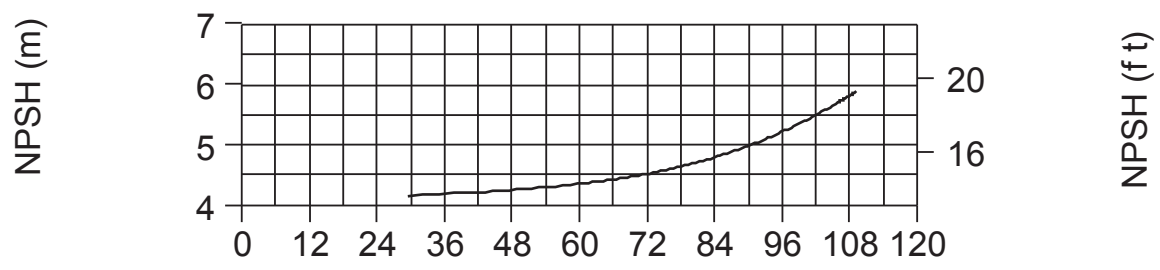
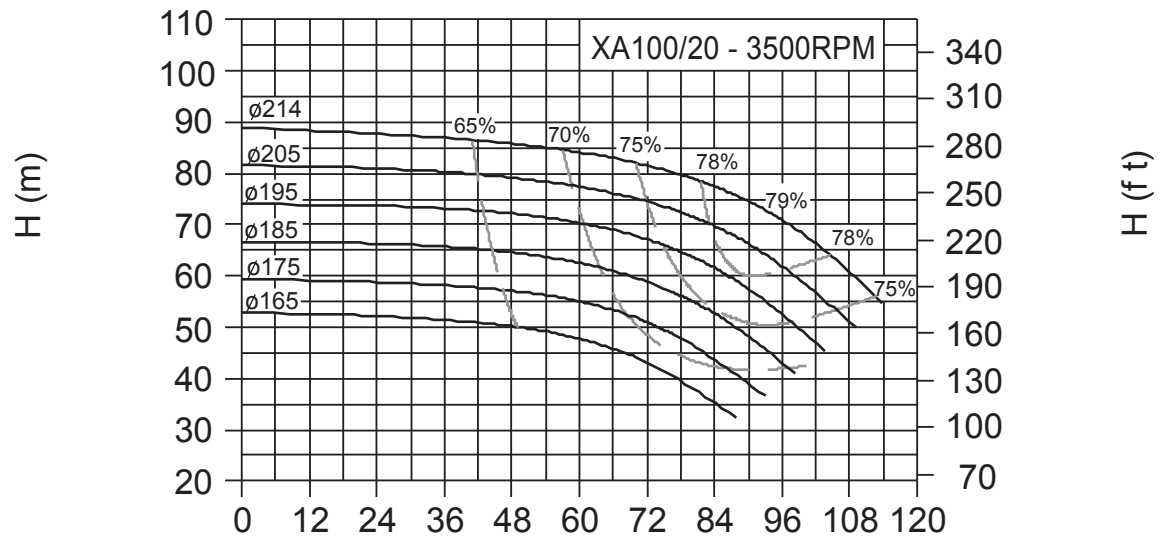



# END SUCTION PUMPS PERFORMANCE CURVES XA SERIES

## XA80/16-2900RPM (50HZ)

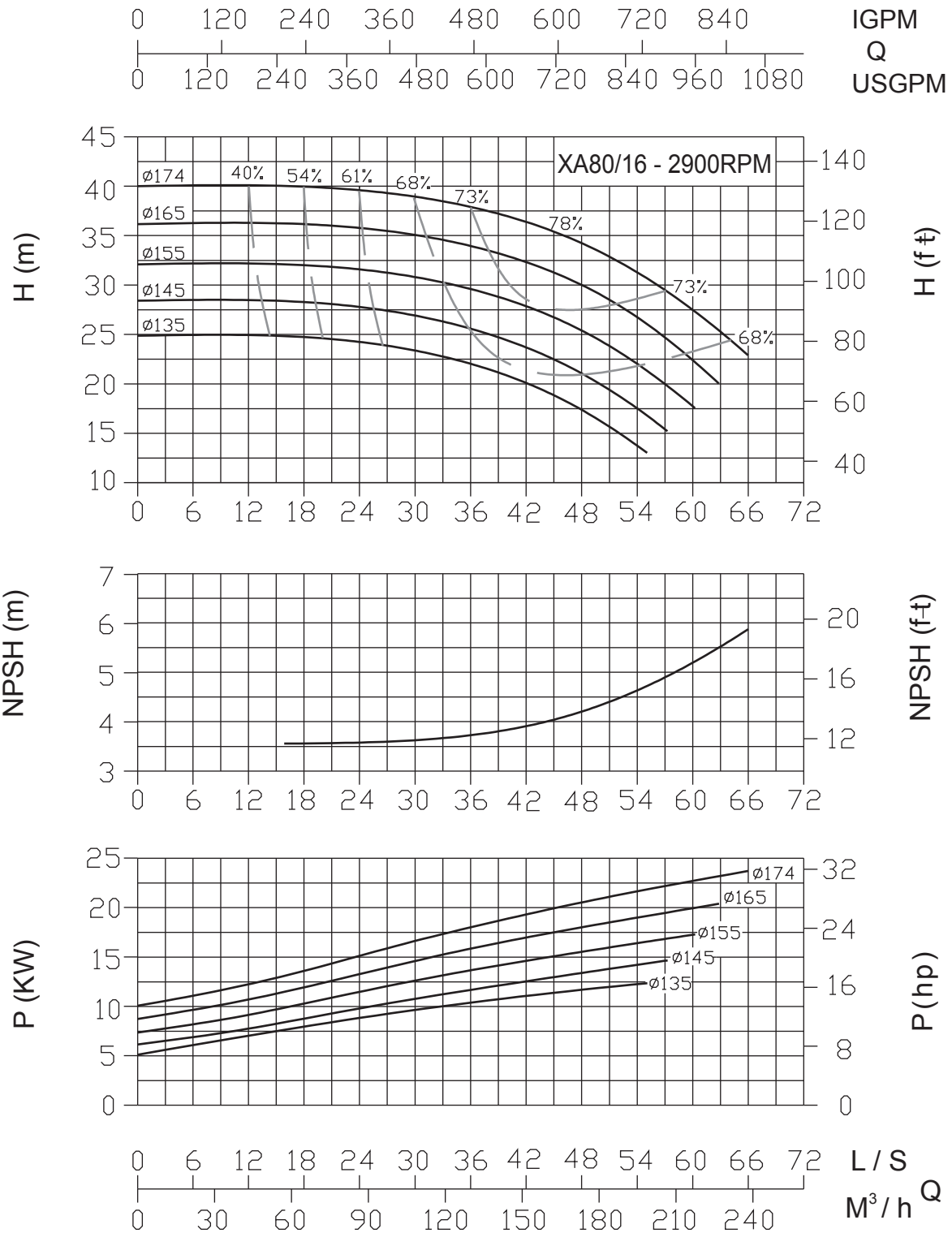





# END SUCTION PUMPS PERFORMANCE CURVES XA SERIES

## XA80/20-2900RPM (50HZ)

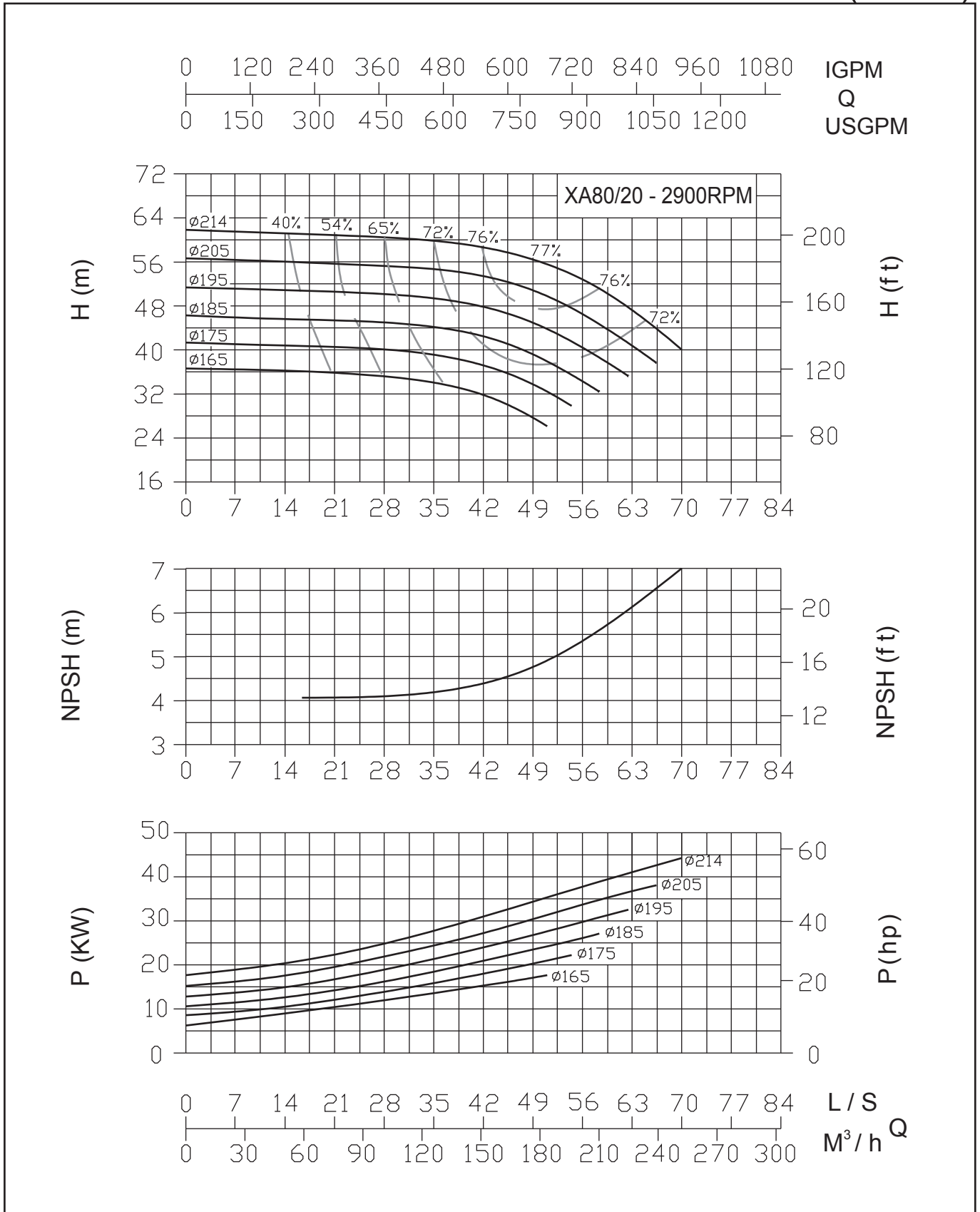



# END SUCTION PUMPS PERFORMANCE CURVES XA SERIES

## XA80/26-2900RPM (50HZ)

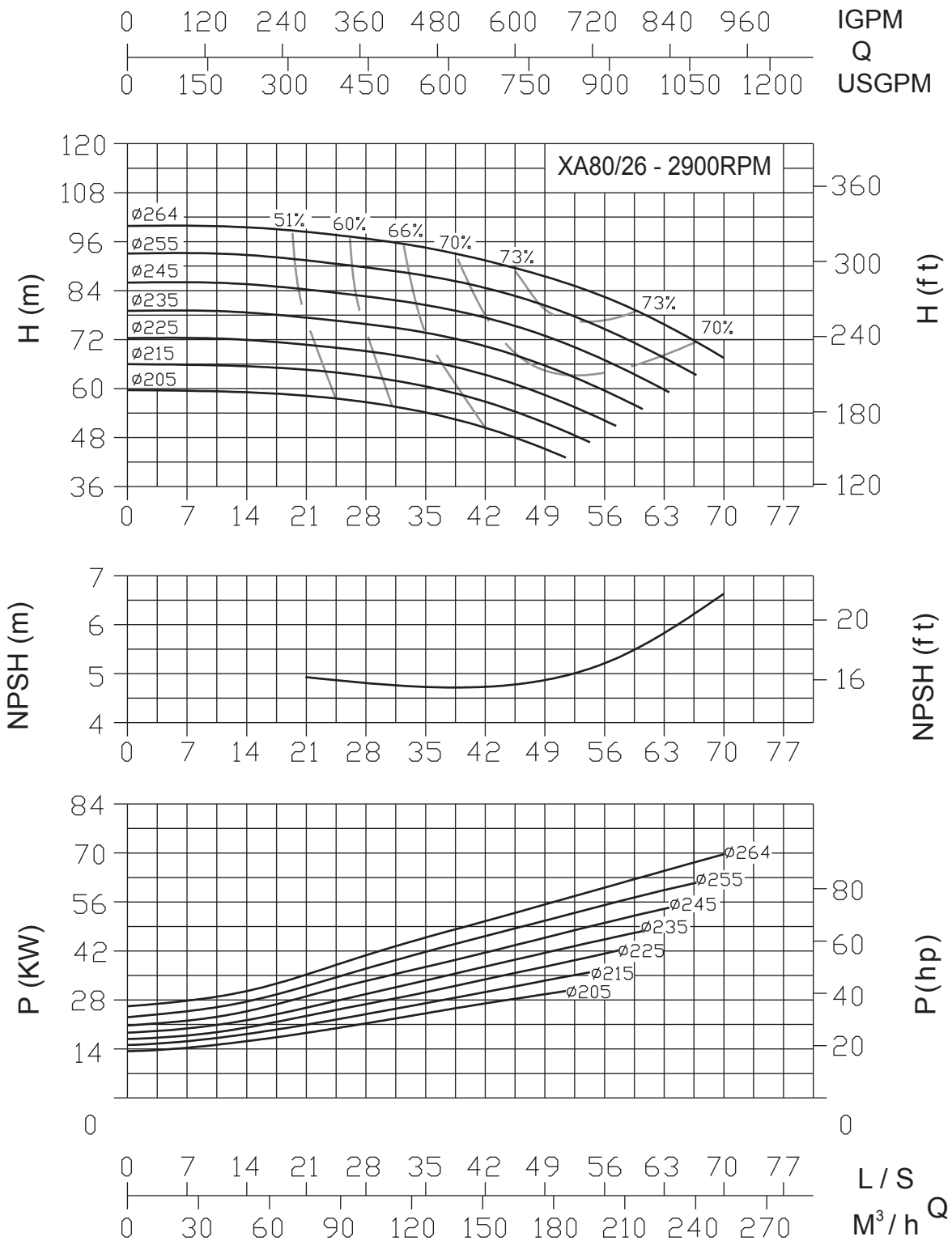



# END SUCTION PUMPS PERFORMANCE CURVES XA SERIES

XA80/32H-2900RPM (50HZ)

XA80/32G-2900RPM (50HZ)

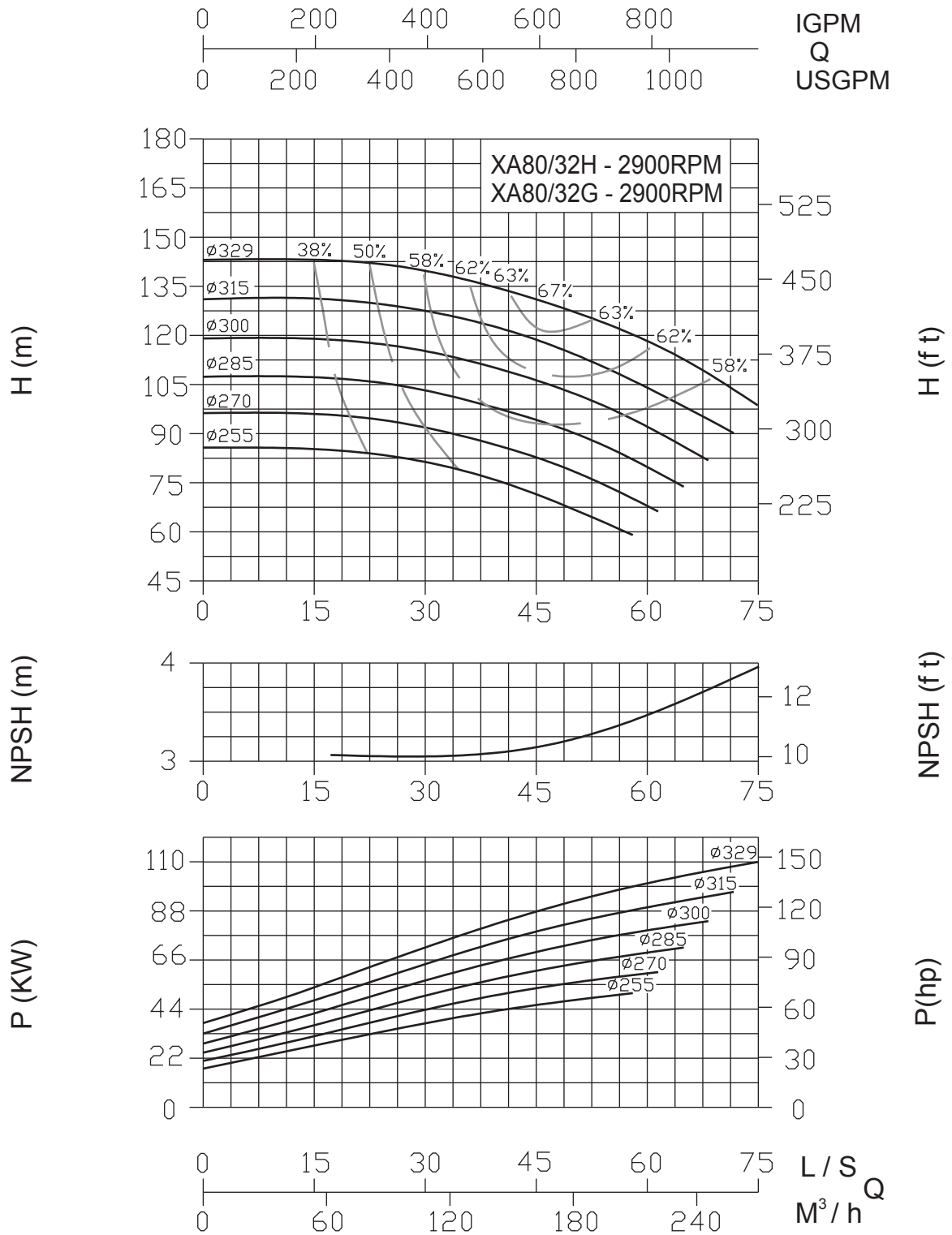



# END SUCTION PUMPS PERFORMANCE CURVES XA SERIES

## XA100/16-2900RPM (50HZ)

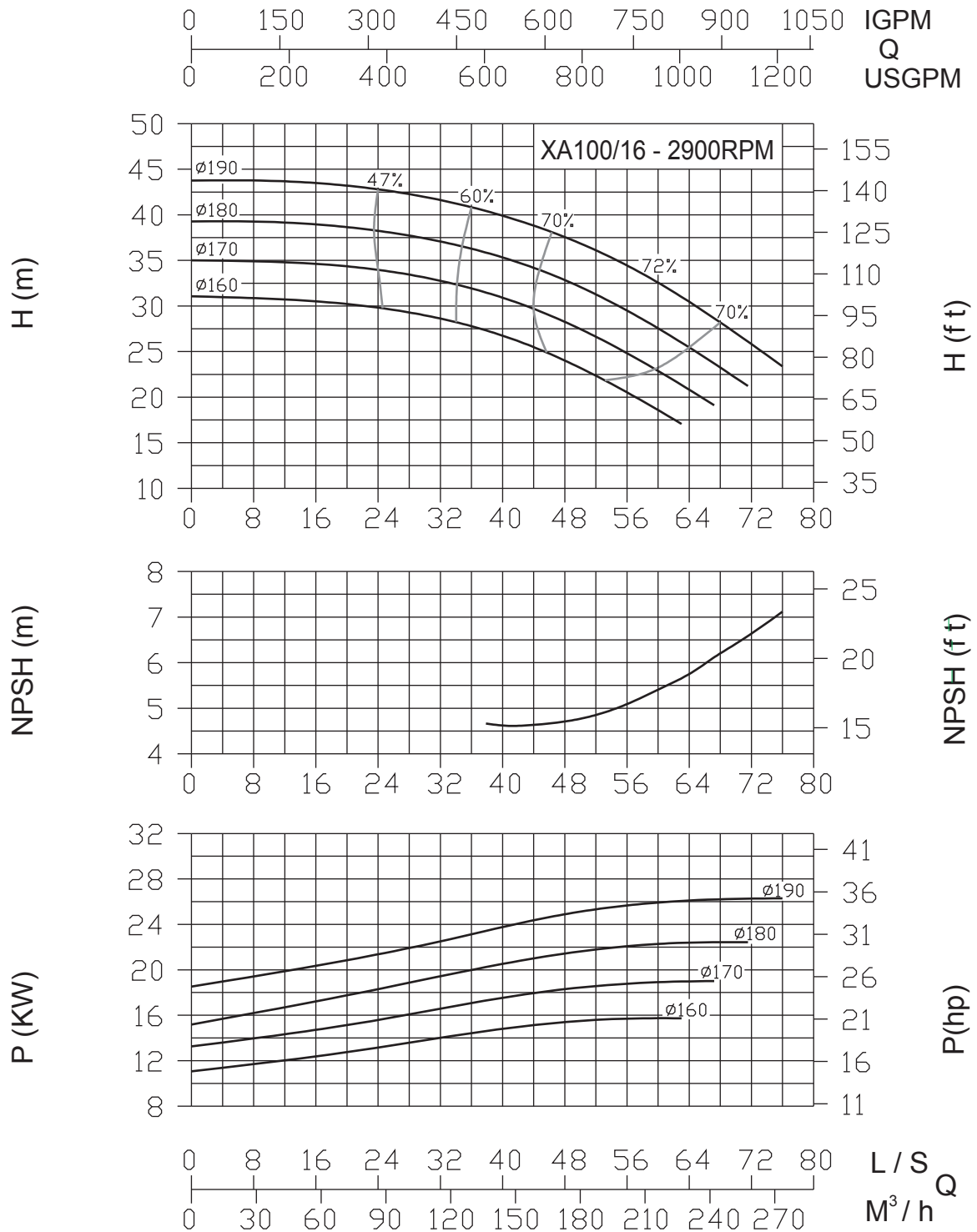

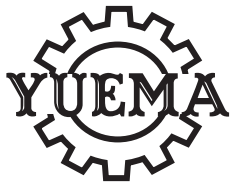

# END SUCTION PUMPS PERFORMANCE CURVES XA SERIES

## XA100/20-2900RPM (50HZ)

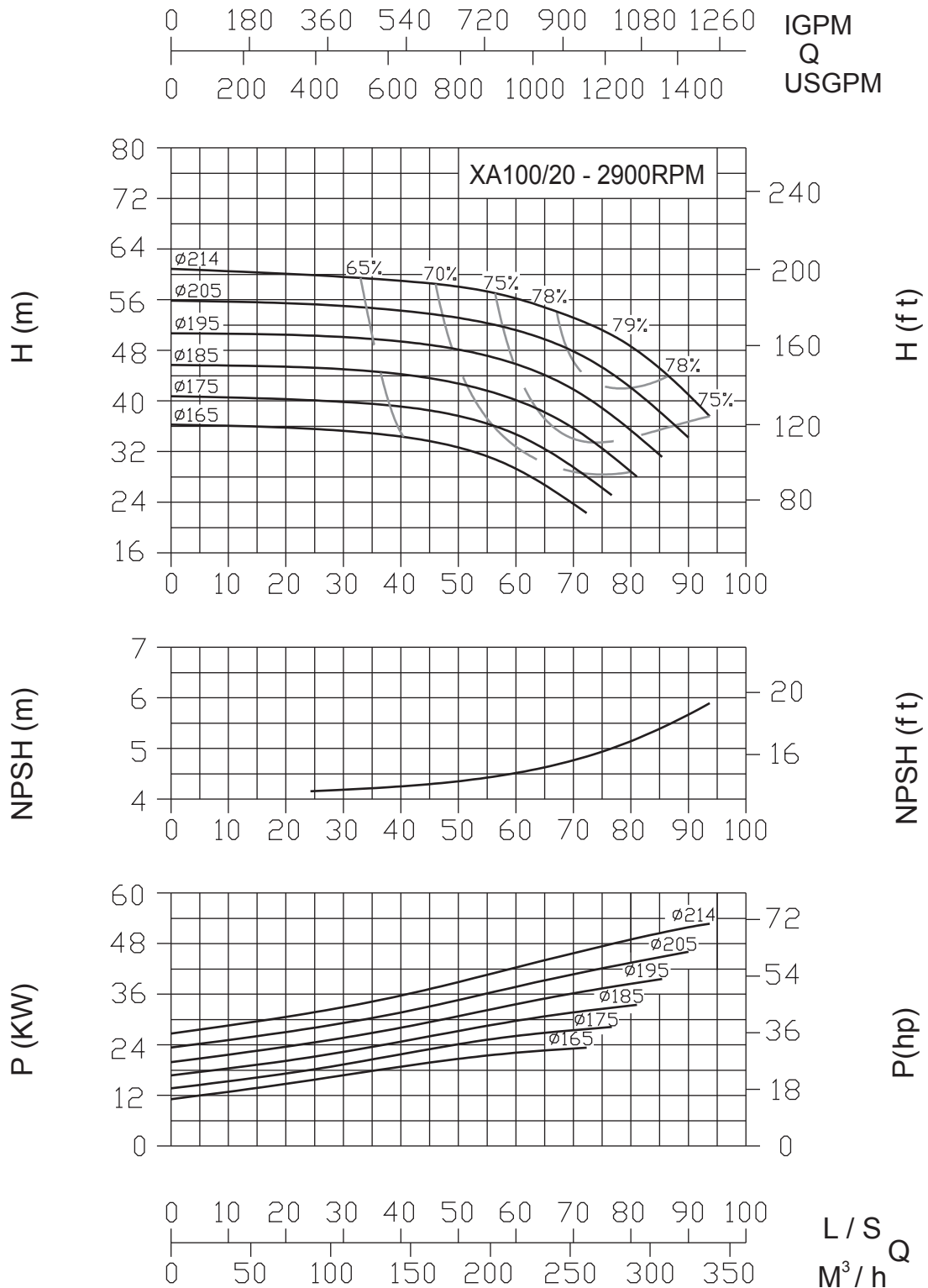

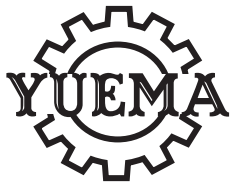

# END SUCTION PUMPS PERFORMANCE CURVES XA SERIES

## XA100/26H-2900RPM (50HZ)

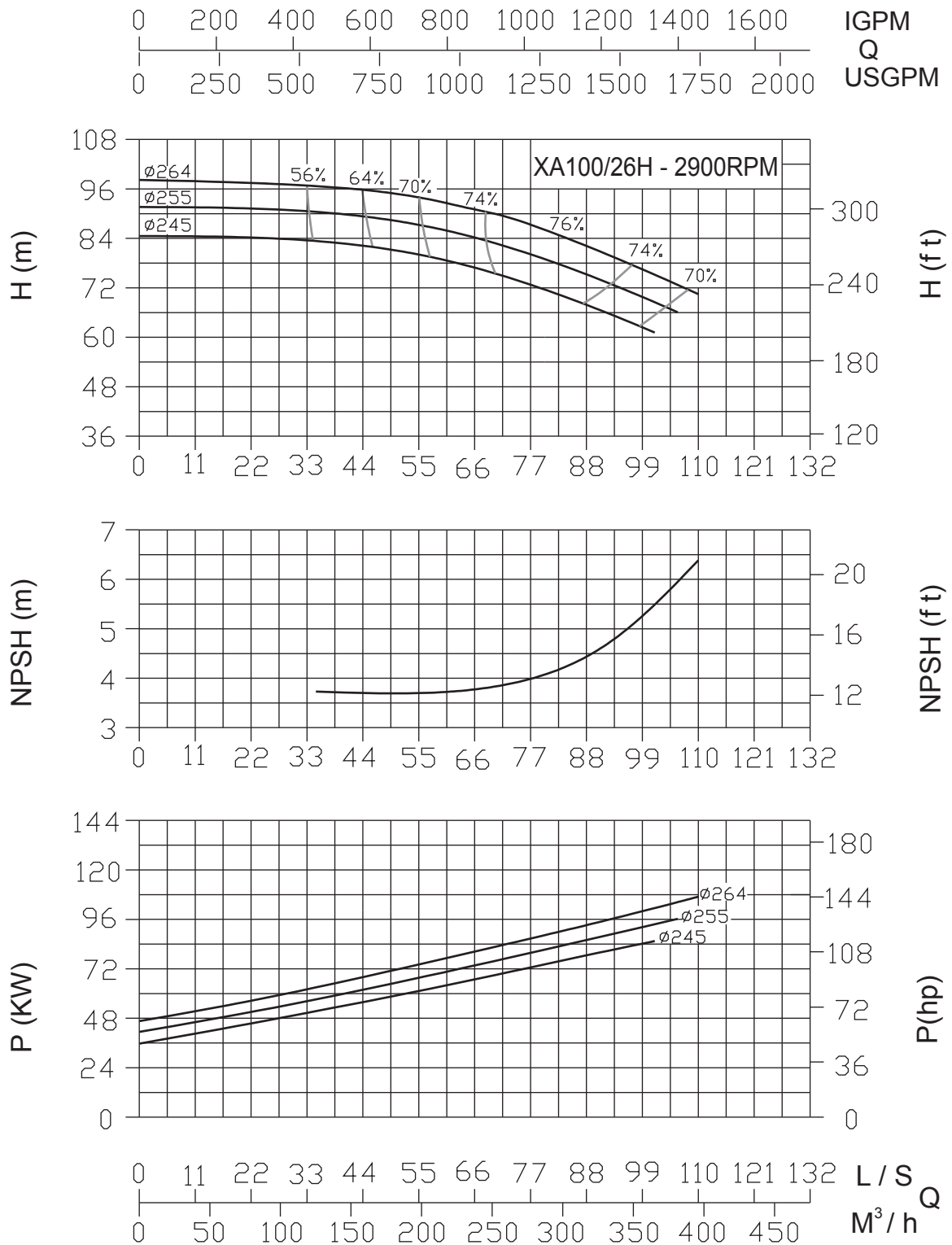

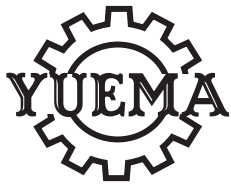

# END SUCTION PUMPS PERFORMANCE CURVES XA SERIES

## XA100/26-2900RPM (50HZ)

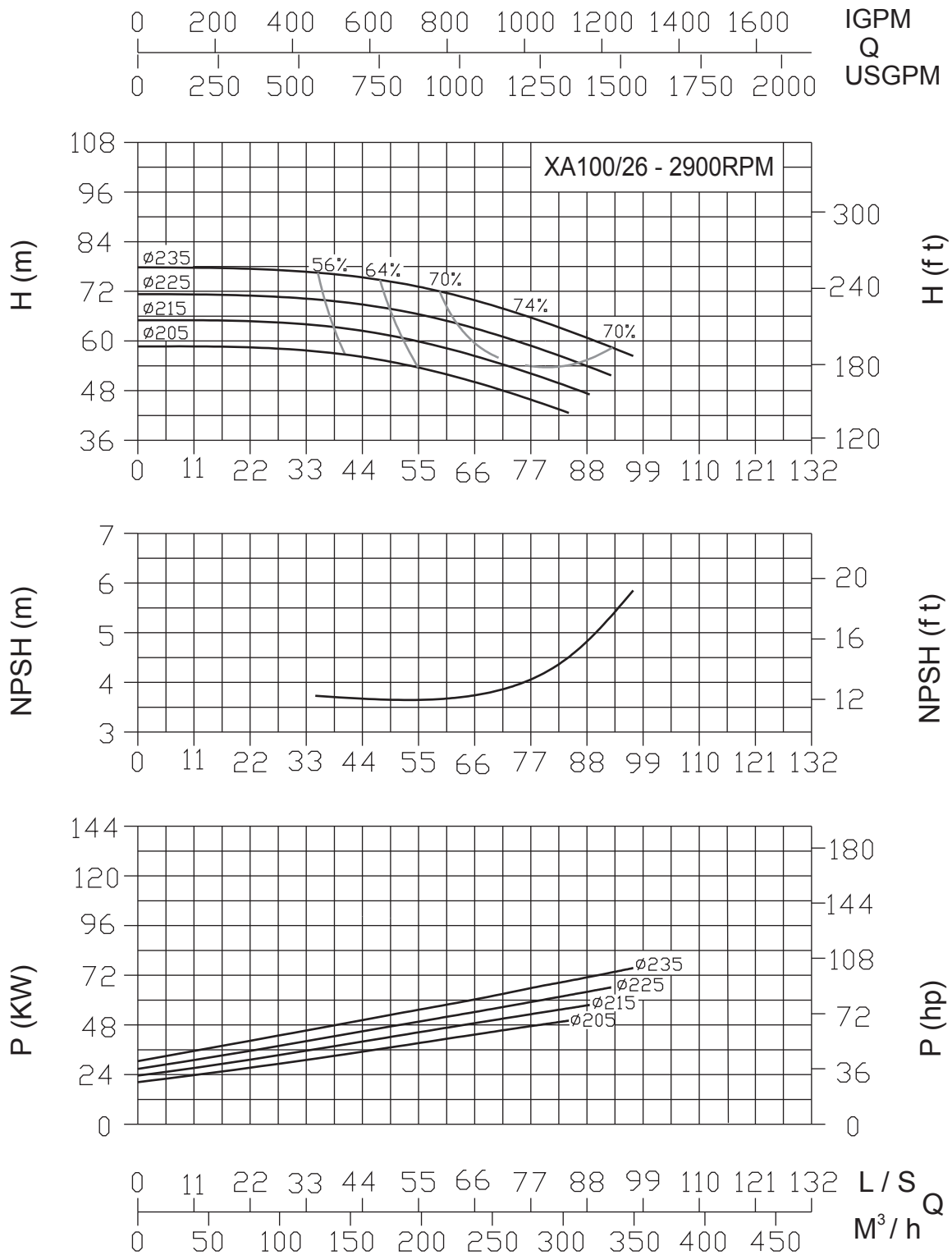



# END SUCTION PUMPS PERFORMANCE CURVES XA SERIES

XA 80/32NH-2900RPM (50HZ)

XA 80/32NG-2900RPM (50HZ)

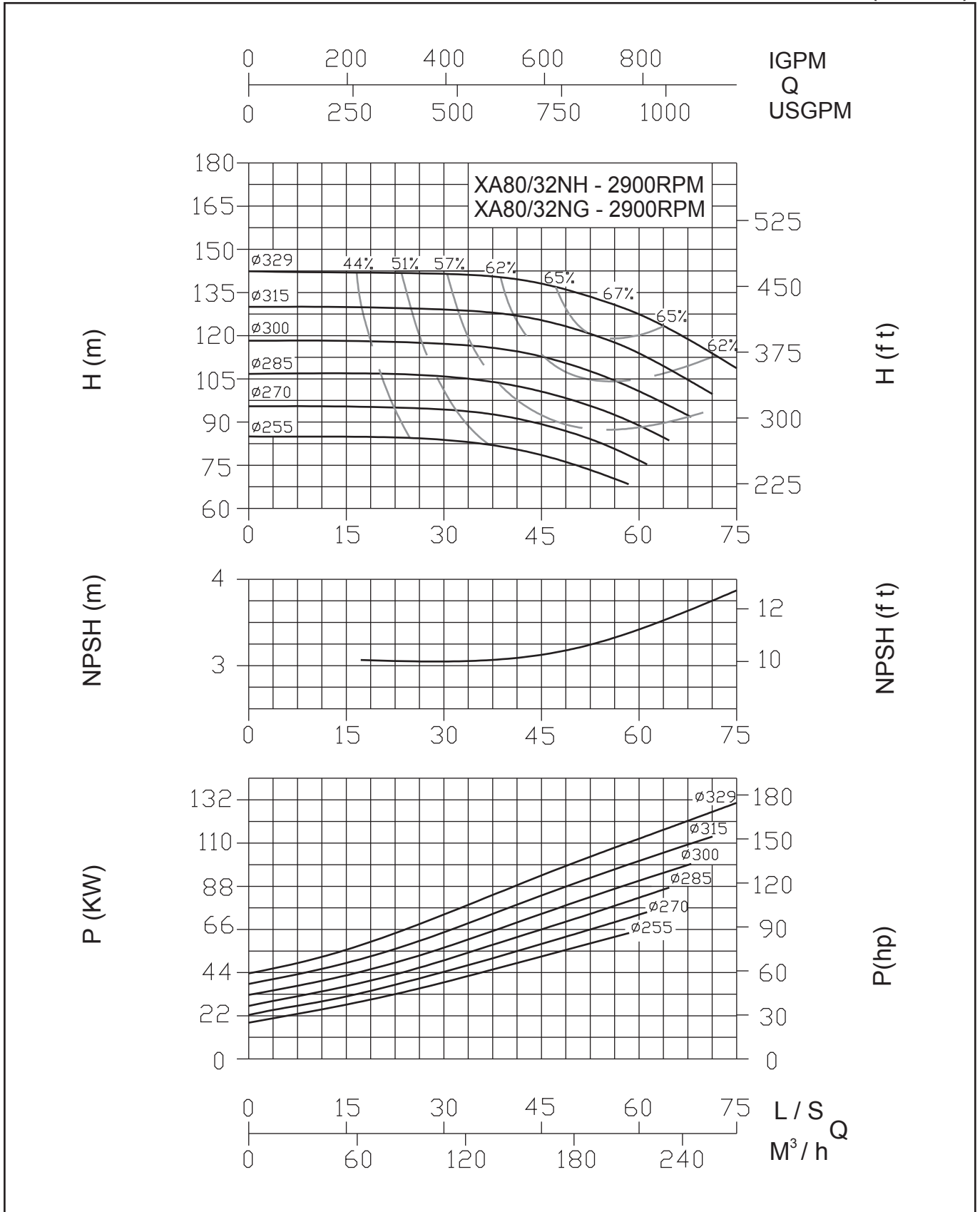





# END SUCTION PUMPS PERFORMANCE CURVES XA SERIES

## XA125/20-2900RPM (50HZ)

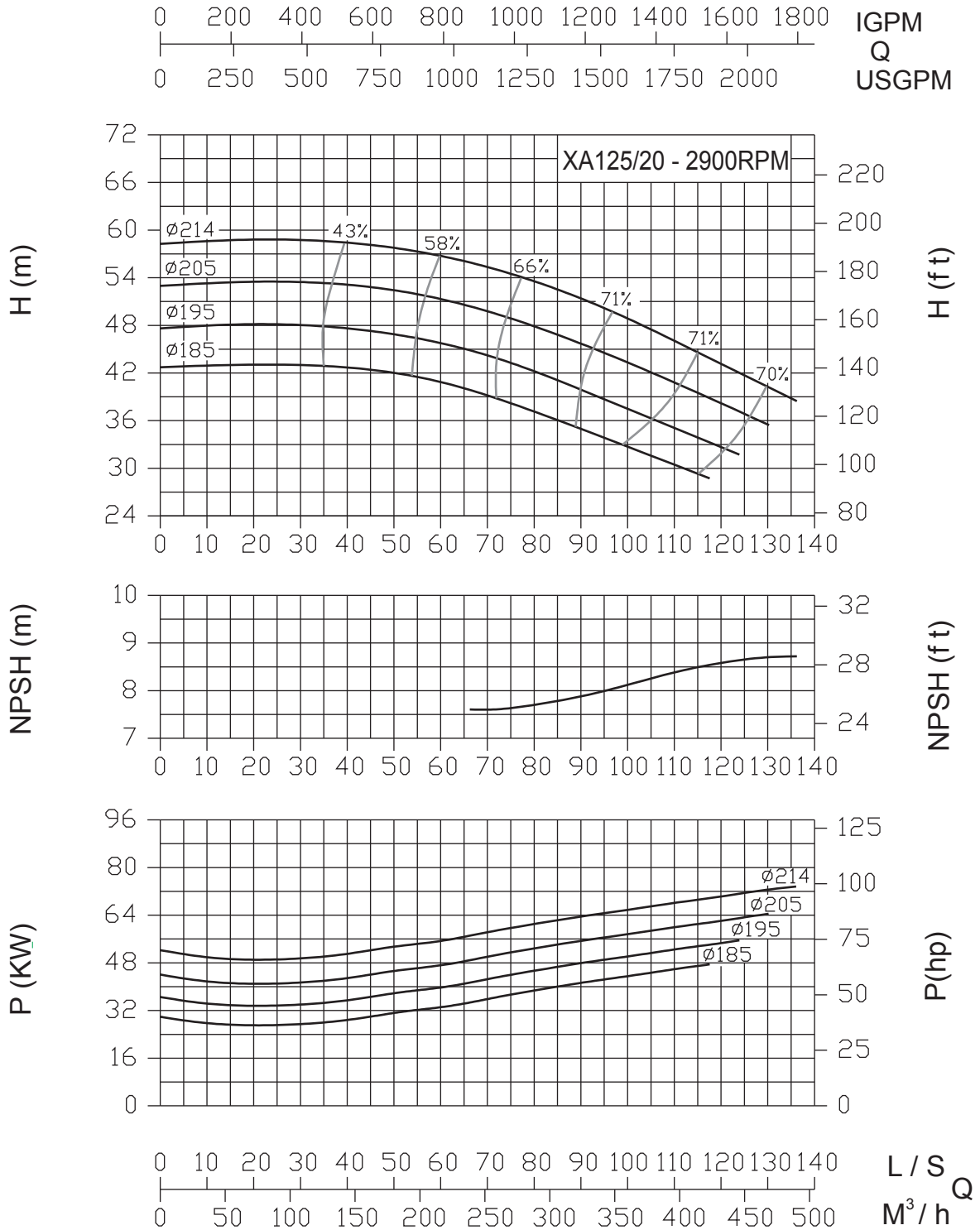



# END SUCTION PUMPS PERFORMANCE CURVES XA SERIES

## XA100/32H-2900RPM (50HZ)

